

Catalogo generale
Carpenterie per quadri elettrici
General catalogue
Enclosure for electrical cabinets



Armadi per quadri elettrici componibili CQE

Caratteristiche Generali	General characteristic	1
Versione montata	Assembled version	4
Versione in kit	Kit version	22
Tetto e base per armadio	Roof and base for cabinet	36
Montanti per armadio	Uprights for cabinet	37
Armadio solo struttura	Modular Cabinet Structure only	38
Armadio con retro	CQE enclosure structure and rear panel	42
Armadio con porta cieca e retro	Modular Cabinets with Blank Door and Rear Panel	47
Armadio con porta cieca doppia anta e retro	Modular Cabinets with Double Blank Door and rear panel	51
Armadio con porta cieca, retro e pannello di cablaggio	Modular Cabinets with Blank Door, rear panel and front mounting plate	54
Armadio con porta trasparente e retro	Modular Cabinets with Glass Door and Rear Panel	57
Armadio con porta in vetro serigrafato e retro	Modular Cabinets with Screen-Printed Glazed Door and rear panel	60
Armadio ad angolo	Corner enclosure	62
Zoccolo per quadro ad angolo	Plinth for corner enclosure	63

CQE modular enclosure

Armadi porta computer industriali

Caratteristiche Generali	General characteristic	65
Armadio porta computer CQEC porta vetro serigrafato	CQEC PC Enclosure with screen-printed glazed door	68
Armadio porta computer CQEC porta cieca	CQEC PC Enclosure with blank door	69
Montante rack 19"	Upright for 19 inch rack	70
Zoccolo per CQEC	CQEC plinth	71
Pannello di cablaggio	Mounting panel	73

CQEC PC computer

Carpenterie EMC

Caratteristiche Generali	General characteristic	75
Armadio EMC	EMC cabinet	77
Kit unione armadi	Baying kit	78
Laterali per armadio EMC	Side panels for EMC cabinet	78
Casse serie CE EMC	EMC Boxes	79
Cassa di derivazione EMC	EMC Junction Boxes	80

Carpenterie EMC

CAES Armadio monoblocco semplificato

Caratteristiche Generali	General characteristic	81
Armadio CAES porta cieca	Compact Simplified Cabinet Blank Door	84
Armadio CAES pannello di cablaggio	Simplified mounting plate for CAES cabinet	85
Zoccolo modulare per CAES	Modular plinth for CAES	86

CAES simplified welded enclosure

Armadio monoblocco saldato CAE per quadro elettrico per applicazioni indoor

Caratteristiche Generali	General characteristic	89
Versione montata	Assembled version	92

CAE welded enclosure

Armadio monoblocco CAE - Solo struttura	CAE Compact Cabinet - Structure only	104
Struttura con retro	Rear panel only	106
Armadio monoblocco CAE - Struttura con retro e porta cieca	CAE Compact Cabinet - Blank door structure	109
Armadio monoblocco CAE - Struttura con retro e porta trasparente	CAE Compact Cabinet - Structure with rear and glass door	112
Armadio monoblocco CAE - Struttura con retro e doppia porta trasparente	CAE Compact Cabinet - Structure with rear and glass double door	114
Armadio monoblocco CAE - Struttura con retro e porta in vetro serigrafato	CAE Compact Cabinet - Structure with rear and screen-printed glass door	115
Armadio monoblocco CAE orizzontale Struttura	CAE Compact Horizontal Cabinet Structure	117
Armadio monoblocco CAE orizzontale Struttura e retro	CAE Compact Horizontal Cabinet Structure and rear panel	118
Armadio monoblocco CAE orizzontale Struttura retro e porta cieca	CAE Compact Horizontal Cabinet Structure rear panel and blank door	119
Porta cieca a doppia anta per armadio CAE orizzontale	Double Blank door for CAE horizontal cabinet	120
Pannello di cablaggio per armadio CAE orizzontale	Mounting panel for CAE horizontal cabinet	121
Retro per armadio CAE orizzontale	Rear panel for horizontal CAE cabinet	122

Accessori armadi

Enclosure accessories

Caratteristiche Generali	General characteristic	123
Pannello di cablaggio a inserimento frontale per CQE e CAE	Front-entry mounting plate for CQE and CAE cabinets	126
Pannello di cablaggio parziale per CQE, CAE	Partial mounting plate for CQE and CAE cabinets	128
Kit squadrette di sostegno pannello di cablaggio parziale	Kit of support cleat angles for partial mounting panels	129
Pannello di cablaggio a inserimento laterale per CQE	Side-entry mounting plate for CQE cabinets	130
Rinforzi trasversali per pannello di cablaggio a inserimento frontale	Reinforcement cross rails for front entry mounting plate	131
Rinforzi trasversali per pannello di cablaggio a inserimento laterale	Reinforcement cross rails for front entry mounting plate	132
Piastra supplementare per pannello di cablaggio a inserimento frontale	Additional panel plate for front-entry mounting plate	133
Kit arretramento pannello di cablaggio a inserimento frontale	Inward installation kit for front entry mounting panels	134
Kit unione piastre ad inserimento laterale	Joining kits for side entry mounting plate	134
Kit montaggio pannello di cablaggio a inserimento frontale	Mounting kit for front entry mounting panels	135
Zoccolo unico in lamiera pressopiegata per CQE	Solid plinth of press-formed steel for CQE	136
Zoccolo a vasca per CQE	Blind plinth for CQE	143
Zoccolo antivibrante per CQE e CAE	Antivibration plinth for CQE and CAE	149
Zoccoli modulari	Modular Plinths	150
Zoccolo per Vano Cavi	Plinth for Cable compartment	153
Staffe di fissaggio zoccolo Tipo A	Plinth fixing brackets Type A	154
Staffe Fissaggio Zoccolo Tipo B	Plinth fixing brackets Type B	155
Piedini di livellamento 0-50 mm per CQE e CAE	Levelling feet for CQE and CAE cabinets, range 0-50 mm	156
Piedini di livellamento 50-100 mm per CQE e CAE	Levelling feet for CQE and CAE cabinets, range 50-100 mm	157
Supporto ruote per CQE e CAE	Castors support for CQE and CAE	158
Ruote pivotanti per armadi	Pivoting castors for cabinets	159
Fondo unico per armadi per CQE e CAE	Solid bottom for CQE and CAE cabinets	160
Profili di guarnizione tenuta fondo universali	Universal bottom sealing profiles	161
Piastra passacavi per CQE e CAE	Cable gland plate for CQE and CAE cabinets	161
Membrana passacavi	Cable grommet	162

Piastra unione per pannelli di cablaggio a inserimento frontale per CQE	Coupler for front-entry mounting plate for CQE cabinets	163
Kit Assemblaggio Quadri	Baying kit for CQE	164
Kit unione sopralzo cavi	Cable riser union kit	165
Kit rinforzo unione armadi CQE	Baying reinforcement kit for CQE cabinets	166
Kit unione posteriore per CQE	Back-to-back baying kit for CQE	167
Porta cieca per CQE e CAE	Blank door for CQE and CAE	168
Porta cieca doppia anta per CQE e CAE	Double blank door for CQE and CAE	170
Porta trasparente per CQE e CAE	Glazed door for CQE and CAE	172
Porta in vetro serigrafato per CQE e CAE	Screen-printed glazed door for CQE and CAE	174
Porta laterale per CQE	Side door for CQE	175
Traversa di sicurezza per CQE	Safety cross rail for CQE	176
Squadrette di sostegno per traversa di sicurezza	Support brackets for safety cross rail	177
Traversino per porta	Door cross rail	178
Porta interna per CQE e CAE	Internal door for CQE and CAE	179
Blocco Porta Meccanico per CQE	Mechanical door interlock for CQE	181
Blocco Porta Antivento	Windproof blank door stop	182
Cerniera 180° per CQE e CAE	180° Hinge for CQE and CAE	182
Blocco porta per armadi in batteria	Door lock for battery cabinets	183
Blocco di sicurezza porta principale	Main door security lock	184
Disp. azion. armadio interruttore generale	Cabinet circuit breaker operating device	184
Blocco porta per armadi in linea	Door block for in-line cabinets	184
Blocco unione aste con staffa sostegno	Rod union bushing with support bracket	185
Sostegno blocco porta aste ultimo armadio	Rod door block support for last battery cabinet	185
Asta blocco porta	Door block rod	186
Mostrina	Simple locking	186
Maniglia a leva con modulo	Lever handle with module	187
Maniglia a leva senza modulo	Lever handle without module	188
Moduli di completamento	Completion modules	189
Retro per CQE e CAE	Rear panel for CQE and CAE	190
Laterali per armadio CQE	Side panels for CQE cabinet	192
Divisorio verticale per CQE	Vertical divider for CQE	194
Sopralzo passaggio cavi modulare per CQE	Modular cable routing top for CQE	196
Pannello intermedio sopralzo passaggio cavi modulare per CQE	Intermediate panel for modular cable routing top for CQE	197
Chiusure laterali per sopralzo passaggio cavi modulare per CQE	Side panels for CQE modular cable routing top	197
Sopralzo smistamento/raccolta cavi per CQE	Cable sorting/collecting top for CQE	198
Chiusure laterali per sopralzo smistamento/raccolta cavi	Side panels for CQE cable sorting/collecting top	199
Vano cavi con apertura laterale per CQE	Cable compartment with side access for CQE cabinet	200
Pannello porta connettori per CQE	Connector carrier for CQE cabinets	201
Adattatori per pannello porta connettori	Adapters for connector carrier	202
Ripiano di lavoro per il montaggio su porta cieca per CQE e CAE	Door tray mountable on blank door for CQE and CAE	202
Ripiano Fisso, montaggio al telaio di CQE e CAE	Fixed tray for CQE and CAE	203
Ripiano estraibile, montaggio al telaio di CQE e CAE	Sliding tray for CQE and CAE cabinets	204
Leggio modulare per CQE	Modular desk for CQE cabinet	205
Tasca portaschemi in plastica	Plastic pocket for wiring diagrams	205
Tasche porta schemi in acciaio	Steel pocket for wiring diagrams	206

Ripiano Porta Tastiera	Tray for keyboard	207
Profili laterali per CQE e CAE	Side rails for CQE and CAE	208
Profili verticali per CQE e CAE	Vertical rails for CQE and CAE	209
Profili frontali per CQE e CAE	Front rails for CQE and CAE	210
Traversa laterale forata H30 mm per CQE e CAE	H30 Perforated side rail for CQE and CAE	211
Traversa laterale forata interna H 30 mm per CQE	H30 Internal perforated side rail for CQE	212
Traversa frontale H 30 mm per CQE e CAE	H30 Front perforated rail for CQE and CAE	213
Profilo ancoraggio cavi per CQE e CAE	Cable tie-down profile for CQE and CAE	214
Traversa porta trasformatore per CQE e CAE	Transformer support cross rail for CQE and CAE	215
Telaio rack 19" totale, larghezza 800 mm	Full 19" rack, width 800 mm	216
Telaio rack 19" totale, larghezza 600 mm	Full 19" rack, width 600 mm	217
Telaio rack 19" totale centrato, larghezza 800 mm	Full centered 19" rack, width 800mm	218
Telaio rack 19" totale, larghezza 1000 mm	Full 19" rack, width 1000 mm	219
Arresto telaio rack	Rack arrester	220
Telaio rack 19" parziale, larghezza 800 mm	Partial 19" rack, width 800 mm	221
Cornice rack 19"	19" rack frame	222
Montante rack 19" a "L"	L-shapede upright for 19" rack	223
Montante rack 19" a "C"	C-shaped upright for 19 inch rack He	224
Squadrette di fissaggio montanti rack	Mounting brackets for rack uprights	225
Fasce verticali per montanti rack	Mounting brackets for rack uprights	226
Pannello rack 19"	Rack plate 19"	227
Sostegno Cassetto Rack	Rack drawer support	228
Pannello di chiusura frontale da 19" forato con cava DIN	19" front panel with DIN cut-out	228
Ripiano fisso per Rack 19"	Fixed tray for rack 19"	229
Ripiano estraibile per Rack 19"	Sliding tray for Rack 19"	230
Traversa Sollevamento	Lifting bar	231
Golfari di sollevamento per CQE e CAE	Lifting eyebolts for CQE and CAE cabinets	232
Squadrette di sollevamento per CQE	Lifting bracket for CQE cabinet	232
Staffa di fissaggio a parete per CQE e CAE	Wall mounting bracket for CQE and CAE cabinets	233
Squadrette di fissaggio universali	Universal mounting brackets	233
Staffe di regolazione	Adjustable bracket	233
Dispositivo antiribaltamento armadi	Anti-tipping device for cabinets	234
Lampada fluorescente	Fluorescent lamp	235
Lampada Led	Led lamp	236
Fissaggio magnetico per lampada a led	Magnetic fixing for led lamp	236
Lampada a led a fissaggio a vite	Screw fixing led lamp	236
Lampada a led interno quadro	Enclosure interior LED light	237
Micro interruttore	Micro-switch	238
Dispositivo lampeggiante trifase	Three-phase flashing unit	238
Viti autofilettanti M 4.8x12	Self-tapping screws M 4.8x12	239
Dadi Speciali	Special nuts	239
Dado a gabbia	Cage nut	240
Vernice spray	Spray Paint	240
Guarnizione Adesiva 8x3	Adhesive gasket 8x3	241
Kit Antisismico Light	Anti-seismic kit - Light	241
Kit Antisismico Medium	Anti-seismic kit - Medium	242
Kit Antisismico Strong	Anti-seismic kit - Strong	243

Modularità esterna

Caratteristiche Generali	General characteristic	244
Armadio con retro	CQE enclosure structure and rear panel	245
Pannelli di compensazione	Blanking panel	247
Traversa di battuta per porte modulari	Modular door ledge	248
Pannello di cablaggio modulare	Modular mounting plate	249
Porta modulare cieca	Modular blank door	251
Porta modulare con cava DIN	Modular door with DIN cut-out	252
Porta modulare con finestra trasparente	Modular door with glazed window	253
Porta modulare interna	Internal modular door	254
Supporto orizzontale parziale e totale	Partial and full horizontal support	255
Divisorio orizzontale parziale e totale	Full and partial horizontal divider	256
Divisorio verticale parziale e totale	Full and partial vertical divider	257
Supporti verticali	Vertical support	258

External modularity

Modularità interna

Caratteristiche Generali	General characteristic	259
Armadio con retro	CQE enclosure structure and rear panel	264
Armadio con porta trasparente e retro	Modular Cabinets with Glass Door and Rear Panel	266
Pannello di cablaggio modulare	Modular mounting plate	268
Supporto orizzontale parziale e totale	Partial and full horizontal support	270
Supporti verticali	Vertical support	271
Montanti per pannelli modulari	Uprights for modular panels	272
Pannelli di compensazione	Blanking panel	273
Pannello modulare con cava DIN	Modular Panel for DIN modules	274
Pannello modulare con fori quadri	Modular Panel + holes	275
Pannello modulare cieco	Blank modular panel	276
Pannello modulare alettato	Finned Modular Panel	277
Pannello modulare di arretramento	Inward modular panel	278
Battuta per pannelli	Ledge for panels	279
Divisorio verticale parziale e totale	Full and partial vertical divider	280
Pannello di tamponamento	Buffer panel	281
Modularità interna con fascia laterale	Internal module with side compartment	282
Supporti laterali per pannello di cablaggio	Side supports for mounting plate	283
Divisorio orizzontale parziale e totale	Full and partial horizontal divider	285
Guida DIN per morsettiere orizzontale	Horizontal DIN guide for terminal boards	286
Traversa di fissaggio supporti per barre - cavi laterale	Side rail for bus supports and cables fixing	286
Traversa di fissaggio supporti per barre - cavi sul fondo dell'armadio	Cross rail bar supports - cables on the bottom of the cabinet	287
Guida DIN regolabile completa di supporti	Adjustable DIN rail with support	288
Staffe per fissaggio canalina cablaggio posteriore	Rear fastening bracket for cable ducts	289
Fissaggio per canalina di cablaggio anteriore orizzontale	Front horizontal fastening bracket for cable ducts	290
Staffe porta canalina per strumenti di misura quadrati	Cable duct bracket for square measurement instruments	291
Staffe porta canalina per pulsanti	Cable duct bracket for pushbuttons	292

Internal modularity

Casse CE

Caratteristiche Generali	General characteristic	293
Anta singola	Single door	298

CE boxes

Doppia anta	Double door	300
Con porta trasparente	With transparent door	301
Con porta vetro serigrafato	With screen-printed glass door	303
Telaio modulare completo	Modular frame	304
Telaio modulare neutro	Neutral modular frame	305
Pannelli avvitati con guida DIN per casse CE	Distribution panel DIN module for CE box	306
Pannelli avvitati ciechi per casse CE	Blank panel for CE box	307
Porta Interna per Casse CE	Internal door for CE boxes	308
Tetto di protezione	Protective canopy for box	309
Guide di rinforzo porta	Reinforcement rails for doors	310
Telaio rack girevole	Rotating 19 inch rack	311
Blocco porta	Door stop	312
Chiusura a box	Box lock	312
Chiusura a cariglione	Ratchet lock	313
Zoccolo completo	Complete plinth H100 mm for CE Boxes	314
Staffa Fissaggio universale	Universal fixing bracket	315
Kit Antisismico Casse CE	Anti-seismic Kit CE Boxes	315

Casse di derivazione CDE

CE junction boxes

Caratteristiche Generali	General characteristic	317
Cassa di derivazione con coperchio avvitato	Junction boxes with screwed cover	320
Cassa di derivazione con coperchio incernierato	Junction boxes with hinged door	322
Cassa di derivazione con flange	Junction boxes with flanges	323
Profili DIN	DIN Profiles	324
Staffa Fissaggio universale	Universal fixing bracket	324
Cerniera per casse di derivazione	Hinges for junction box covers	325
Piastra interna per casse di derivazione	Internal plate for CDE junction boxes	326

Casse INOX

Stainless steel CE boxes

Caratteristiche Generali	General characteristic	329
Casse serie CE Inox - Anta singola	Stainless steel CE Box - Single door	334
Casse serie CE Inox - Doppia anta	Stainless steel CE Box - Double door	336
Casse serie CE Inox porta trasparente	CE Box with glazed door AISI 304	337
Porta Interna Cassa Inox	Internal door for AISI 304 box	339
Telaio modulare completo per casse CE Inox	Modular frame for CE and AISI 304 CE Box	340
Telaio modulare per casse CE Inox - Solo cornice	Modular frame for CE and AISI 304 CE Box - frame only	341
Pannelli avvitati ciechi per casse CE Inox	Blank panel for CE and AISI 304 CE Box	342
Pannelli avvitati con guida DIN per casse CE Inox	Distribution panel DIN module for CE and AISI 304 CE Box	343
Tetto Protezione Casse INOX	Protective canopy INOX	344
Staffa Fissaggio Ce-Cde AISI 316	Fixing bracket CE-CDE AISI 316	344
Guide di rinforzo porta	Reinforcement rails for doors	345
Box casse in acciaio Inox AISI 316	AISI 316 Locking system	346
Chiusura a box per Casse CE	Box lock for CE Box	346
Chiusura a cariglione per casse CE	Ratchet lock for CE Box	347
Casse CDE Inox - Cassa Derivazione AISI 304	CDE box AISI 304 - Junction Box AISI 304	348
Profili DIN	DIN Profiles	349
Piastra interna per casse di derivazione	Internal plate for CDE junction boxes	350

Pulpiti industriali

Consoles

Caratteristiche Generali	General characteristic	353
Pulpito compatto PN	PN compact console	356
Cassa Pulpito Componibile	Modular console base	357
Alzata Pulpito Componibile	Modular console top	358
Mensola pulpito componibile	Modular console desk	359
Coperchio per pulpito componibile	Cover for Modular consoles	360
Cassa Pulpito Video	Video console base	361
Alzata Pulpito Video	Video console top	362
Mensola Pulpito Video	Video console desk	363
Coperchio Pulpito Video	Cover for video console	364
Pannello di cablaggio supplementare per cassa serie componibile e video	Additional mounting plate for modular and video cabinets	365
Pannello porta apparecchiature per serie componibile e video	Equipment support panel for modular and video desks	366
Tasca portaschemi in plastica	Plastic pocket for wiring diagrams	367
Golfari di sollevamento per pulpiti	Lifting eyebolts for consoles	367
Traversini porta apparecchiature serie PN	Equipment support rails for PN desks	367
Traversini porta apparecchiature serie componibile e video	Equipment support rails for modular and video desks	368
Zoccoli per Pulpito serie COMPATTO PN e COM-PONIBILE	Plinth for COMPACT PN and MODULAR consoles series	369
Zoccoli per Pulpito VIDEO	Plinth for VIDEO series	370
Molle a Gas	Gas springs	371
Chiusura a box per pulpiti	Box lock for consoles	371

Pulpito Inox

Inox console

Caratteristiche Generali	General characteristic	373
Pulpito compatto	Compact console	375
Traversini porta apparecchiature serie PN	Equipment support rails for PN desks	376
Angolare Zoccolo H.100 mm AISI 304	Plinth Angular H.100 Stainless Steel AISI 304	376
Profilo Zoccolo AISI 304	Plinth Flange Stainless Steel AISI 304	377

Sistema Light

Light system

Caratteristiche Generali	General characteristic	379
Giunto con partenza da terra per tubo diam.48mm	Joint from ground for pipe diam. 48mm	387
Giunto con partenza da terra per tubo diam.70mm	Joint from ground for pipe diam. 70mm	388
Snodo torretta rotante	Rotating turret	389
Snodo attacco parete	Wall mount hinge	390
Adattatore angolare 90°	90 degrees angle coupling	391
Adattatore angolare 90° 60X40 - Diam. 70 mm	90 degrees angle coupling 60X40 - 70 mm diam.	392
Adattatore angolare 90° rotante 60X40 - Diam. 70 mm	90 degrees angle coupling rotating 60X40 - 70 mm diam.	393
Snodo dritto diametro 48 mm	Straight joint Ø 48 mm	394
Snodo dritto diametro 48 mm inclinabile	Tilting straight joint Ø 48 mm	395
Snodo intermedio	Intermediate hinge	396
Snodo 90° 60x40	90° joint 60x40	397
Snodo 90° 60x40 inclinabile	Tilting 90° joint 60x40	398
Tubo rettangolare 60x40 mm	60x40 mm square tube	399
Tubo circolare d.48mm	Circular pipe 48 mm diameter	400
Tubo circolare d.70mm	Circular pipe 70 mm diameter	401
Staffa rinforzo per giunto a parete sistema LIGHT	Reinforcement bracket for LIGHT system wall mount hinge joint	402

Staffa rinforzo torretta rotante sistema Light	Reinforcement bracket for Light system rotating turret joint	402
--	--	-----

Piastra di rinforzo per contenitore per sistema LIGHT	Reinforcement plate for enclosures purposed for LIGHT system	402
---	--	-----

Sistema Medium

Medium system

Caratteristiche Generali	General characteristic	403
--------------------------	------------------------	-----

Giunto con partenza da terra	Joint from ground	407
------------------------------	-------------------	-----

Giunto a parete	Wall mount joint	408
-----------------	------------------	-----

Giunto intermedio	Intermediate joint	409
-------------------	--------------------	-----

Torretta rotante Medium	Medium Rotating turret	410
-------------------------	------------------------	-----

Adattatore angolare 90°	90 degrees angle coupling	411
-------------------------	---------------------------	-----

Tubo quadro 50x50 mm	50x50 mm square tube	412
----------------------	----------------------	-----

Snodo dritto	Straight joint	413
--------------	----------------	-----

Snodo rotante 90° Medium	90 degrees rotating joint Medium	414
--------------------------	----------------------------------	-----

Staffa rinforzo per giunto a parete sistema MEDIUM	Reinforcement bracket for MEDIUM system wall mount joint	414
--	--	-----

Staffa rinforzo per torretta rotante sistema Medium	Reinforcement bracket for Medium system rotating turret	415
---	---	-----

Piastra di rinforzo per contenitore per sistema MEDIUM	Reinforcement plate for enclosures purposed for MEDIUM system	415
--	---	-----

Sistema Heavy

Heavy system

Caratteristiche Generali	General characteristic	416
--------------------------	------------------------	-----

Giunto con partenza da terra	Joint with starts from ground	420
------------------------------	-------------------------------	-----

Giunto a parete	Wall mount joint	421
-----------------	------------------	-----

Giunto intermedio	Intermediate joint	422
-------------------	--------------------	-----

Torretta rotante Heavy	Rotating turret	423
------------------------	-----------------	-----

Adattatore angolare 90°	90 degrees angle coupling	424
-------------------------	---------------------------	-----

Snodo rotante dritto	Straight joint	425
----------------------	----------------	-----

Snodo rotante 90°	90 degrees rotating joint	426
-------------------	---------------------------	-----

Tubo quadro 80 mm	80x80 mm square tube	426
-------------------	----------------------	-----

Staffa rinforzo per torretta rotante sistema HEAVY	Reinforcement bracket for HEAVY system rotating turret joint	427
--	--	-----

Staffa rinforzo per giunto a parete sistema HEAVY	Reinforcement bracket for HEAVY system wall mount joint	427
---	---	-----

Piastra di rinforzo per contenitore per sistema HEAVY	Reinforcement plate for enclosures purposed for HEAVY system	427
---	--	-----

Contenitori Aluframe

Aluframe control enclosures

Contenitori di comando serie ALUFRAME	Front panels for ALUFRAME control enclosures	428
---------------------------------------	--	-----

Piastra di montaggio per contenitori di comando serie ALUFRAME	Mounting panel for ALUFRAME control enclosures	429
--	--	-----

Maniglia Rack	Universal handle for rack frames	429
---------------	----------------------------------	-----

Pannelli frontali per contenitori di comando serie ALUFRAME (accessori di ricambio)	Replacement front plate for ALUFRAME control cabinet	430
---	--	-----

Approfondimenti

Aluframe control enclosures

Caratteristiche Generali	General characteristic	431
--------------------------	------------------------	-----



Armadio componibile CQE CQE Modular Enclosures

■ Armadio componibile CQE

CQE Modular Enclosures

Per installazione indoor For indoor installation



La linea di armadi componibili CQE è costituita da sei altezze standard, da 1200 a 2200 mm.

La verniciatura viene eseguita di serie con polveri poliesteri o epossipoliesteri, colore standard RAL 7035 bucciato con tetto, base e zoccolo RAL 7011 bucciato.

Il ciclo di verniciatura standard applicato è classificabile, secondo la norma UNI ISO 12944-2018, come C3 con durabilità M.

Il grado di protezione dell'armadio CQE è IP55 in versione standard. Secondo determinate condizioni tecniche e con utilizzo del Fondo Unico, è elevabile ad IP65. Maggiori dettagli tecnici a pag.?? del presente catalogo.

Struttura

- Profili in lamiera d'acciaio spessore 15/10
- Chiusura fondo con tre flange asportabili

Porta

- In lamiera d'acciaio spessore 20/10
- Telaio interno forato con passo 25mm
- Guarnizione perimetrale poliuretanic, applicata in colata continua
- Previste quattro cerniere in zama con angolo di apertura 130°
- Previsti quattro punti di chiusura
- Possibilità di montaggio sia frontale, sia posteriore

Pannello di cablaggio

- In lamiera d'acciaio zincata SENDZIMIR®, spessore 25/10
- Bordatura perimetrale da "U" da 25mm
- Possibilità di montaggio arretrato, allineato ai montanti posteriori, tramite apposito kit
- Possibilità di montaggio di due piastre contrapposte

Pannelli laterali

- In lamiera d'acciaio spessore 15/10
- Forniti in confezione da due pezzi

Pannello posteriore

- In lamiera d'acciaio spessore 15/10

Nel caso in cui venga ordinata una carpenteria CQE con colore diverso dallo standard, la procedura prevede che lo stesso colore venga realizzato anche per i pannelli di base, la struttura, il tetto e il fondo.

The CQE line of modular cabinets consists of six standard heights, from 1200 to 2200mm.

The painting is carried out as standard with epoxy-polyester powders, standard color RAL 7035 textured with roof, base and plinth RAL 7011 textured.

The applied standard painting cycle can be classified, according to UNI ISO 12944-2018, as C3 with durability M.

The degree of protection of the CQE cabinet is IP55 in the standard version. According to certain technical conditions and with the use of the Single Fund, it can be raised to IP65. More technical details on page. of this catalog.

Structure

- 15/10 thick sheet steel profiles
- Bottom closure with three removable flanges

Door

- 20/10 thick sheet steel
- Perforated internal frame with 25mm pitch
- Perimeter polyurethane gasket, applied in continuous casting
- Provided with four zamak hinges with 130° opening angle
- Four closing points provided
- Possibility of front and rear mounting

Wiring panel

- In SENDZIMIR® galvanized steel sheet, thickness 25/10
- Perimeter "U" border of 25mm
- Possibility of backward mounting, aligned to the rear uprights, by means of a special kit
- Possibility of mounting two opposite plates

Side panels

- 15/10 thick sheet steel
- Supplied in a two-piece pack

Back panel

- 15/10 thick sheet steel

In case you order a CQE enclosure with a different color from the standard, the procedure require that the same color is also applied to he base panels, structure, roof and bottom.



■ Armadio componibile CQE

CQE Modular Enclosures

Per installazione indoor For indoor installation

Conformità e omologazioni Conformity and approvals

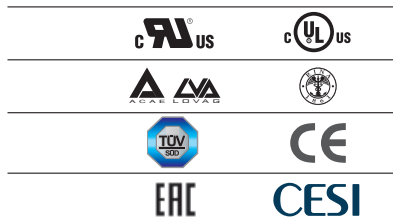

- **IP 55** in accordo con IEC EN 62208; EN 60529
- **TYPE 4** in accordo con UL508A; UL50 (singola anta cieca)
- **TYPE 12** in accordo con UL508A; UL50 (doppia anta cieca)
- Grado di protezione garantito dalla guarnizione in schiuma poliuretana bi-componente
- Grado di resistenza all'urto **IK10** in accordo con IEC EN 62208; EN 62262

Protection degree

- **IP 55** according to IEC EN 62208; EN 60529
- **TYPE 4** according to UL508A; UL50 (single blind door)
- **TYPE 12** according to UL508A; UL50 (double blind door)
- The protection degree is guaranteed by a seal of two-component polyurethane foam
- Impact resistance degree **IK10** according to IEC EN 62208; EN 62262

Tetto asportabile per garantire accessibilità totale anche dall'alto.
Removable roof assuring a complete accessibility even from the top.

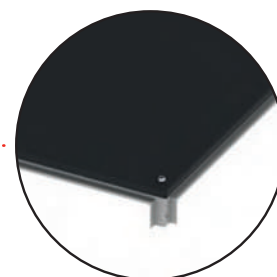

Retro asportabile universale per serie CQE e CAE.
Removable rear panel universal for CQE and CAE series

Giunti ortogonali in alluminio pressofuso. Consentono l'assemblaggio dell'armadio con sole 16 viti.
Die-cast aluminum orthogonal joints. Allow assembling the enclosure by means of 16 screws only.

Pareti asportabili per consentire l'accesso laterale all'armadio e l'assemblaggio in batteria.
Removable side panels to allow side access and baying.

Montanti ripiegati 8 volte e saldati.
Uprights folded 8 times and welded.

Fondo ingresso cavi regolabile in lamiera zincata.
Adjustable bottom gland plate made of galvanized steel.



Porta anteriore con telaio di rinforzo di serie, universale per serie CQE e CAE.
Front door with standard reinforcement frame, universal for CQE and CAE series.

Chiusura standard a cariglione. Altre chiusure disponibili a richiesta.
Standard ratchet lock. Other types of locking elements available upon request.

Cerniere in zama pressofuse apertura 130° std, disponibile apertura a 180°.
Die-cast zamak hinges with the standard opening angle of 130°, 180° opening is available upon request.

■ Armadi per quadri elettrici componibili CQE

CQE modular enclosure

Versione montata
Assembled version

H 1200



DIMENSIONI ARMADIO ENCLOSURE DIMENSIONS		ARMADIO SOLO STRUTTURA ENCLOSURE STRUCTURE ONLY	ARMADIO CON RETRO ENCLOSURE WITH REAR PANEL	ARMADIO CON PORTA CIECA E RETRO ENCLOSURE WITH BLANK DOOR AND REAR PANEL	ARMADIO CON PORTA TRASP. E RETRO ENCLOSURE WITH GLASS DOOR AND REAR PANEL	ARMADIO CON PORTA IN VETRO SERIGR. E RETRO SCREEN-PRINTED GLASS DOOR AND REAR PANEL ENCLOSURE
L W	P D					
400	400	R5CQE1244S	R5CQE1244R	R5CQE1244		
	500	R5CQE1245S	R5CQE1245R	R5CQE1245	-	
	600	R5CQE1246S	R5CQE1246R	R5CQE1246		
600	400	R5CQE1264S	R5CQE1264R	R5CQE1264	R5CQE1264X	
	500	R5CQE1265S	R5CQE1265R	R5CQE1265	R5CQE1265X	
	600	R5CQE1266S	R5CQE1266R	R5CQE1266	R5CQE1266X	
800	400	R5CQE1284S	R5CQE1284R	R5CQE1284	R5CQE1284X	
	500	R5CQE1285S	R5CQE1285R	R5CQE1285	R5CQE1285X	-
	600	R5CQE1286S	R5CQE1286R	R5CQE1286		
1000	400	R5CQE12104S	R5CQE12104R	R5CQE12104		
	500	R5CQE12105S	R5CQE12105R	R5CQE12105		
	600	R5CQE12106S	R5CQE12106R	R5CQE12106	-	
**1200	400	R5CQE12124S	R5CQE12124R	R5CQE12124		
	500	R5CQE12125S	R5CQE12125R	R5CQE12125		
	600	R5CQE12126S	R5CQE12126R	R5CQE12126		

* Tetto con flangia / Roof with a flange
** Armadio con doppia anta / Doble door cabinet

Accessori correlati Related accessories

Montanti
Uprights



Pag. 37

Pannelli di cablaggio
Mounting Panels



Pag. 126

Porte
Doors



Pag. 168

Retro
Rear Panel



Pag. 189

Laterali
Side panels



Pag. 191

■ Armadi per quadri elettrici componibili CQE

CQE modular enclosure

Versione montata
Assembled version

H 1200



DIMENSIONI ARMADIO ENCLOSURE DIMENSIONS		PANNELLO CABLAGGIO MOUNTING PANEL	LATERALI SIDE PANELS	ZOCOLO H.100 PLINTH H.100			ZOCOLO H.200 PLINTH H.200		
L W	P D			ANGOLARE ANGULAR	FLANGIA FRONTALE FRONT FLANGE	FLANGIA LATERALE SIDE FLANGE	ANGOLARE ANGULAR	FLANGIA FRONTALE FRONT FLANGE	FLANGIA LATERALE SIDE FLANGE
400	400	RZPCE1240	R5LE1242	R1ZCOR1	R1ZPRO401	R1ZPRO401	R1ZCOR2	R1ZPRO402	R1ZPRO401
	500		R5LE1252			R1ZPRO501			R1ZPRO502
	600		R5LE1262			R1ZPRO601			R1ZPRO602
600	400	RZPCE1260	R5LE1242	R1ZCOR1	R1ZPRO601	R1ZPRO401	R1ZCOR2	R1ZPRO602	R1ZPRO401
	500		R5LE1252			R1ZPRO501			R1ZPRO502
	600		R5LE1262			R1ZPRO601			R1ZPRO602
800	400	RZPCE1280	R5LE1242	R1ZCOR1	R1ZPRO801	R1ZPRO401	R1ZCOR2	R1ZPRO802	R1ZPRO401
	500		R5LE1252			R1ZPRO501			R1ZPRO502
	600		R5LE1262			R1ZPRO601			R1ZPRO602
1000	400	RZPCE12100	R5LE1242	R1ZCOR1	R1ZPRO1001	R1ZPRO401	R1ZCOR2	R1ZPRO1002	R1ZPRO401
	500		R5LE1252			R1ZPRO501			R1ZPRO502
	600		R5LE1262			R1ZPRO601			R1ZPRO602
**1200	400	RZPCE12120	R5LE1242	R1ZCOR1	R1ZPRO1201	R1ZPRO401	R1ZCOR2	R1ZPRO1202	R1ZPRO401
	500		R5LE1252			R1ZPRO501			R1ZPRO502
	600		R5LE1262			R1ZPRO601			R1ZPRO602

* Tetto con flangia / Roof with a flange
** Armadio con doppia anta / Doble door cabinet

Accessori correlati Related accessories

Zocchi
Plinth



Pag. 150

Chiusure
Locking elements



Pag. 187

Profili
Profiles



Pag. 207

Telai rack 19"
Rack 19"



Pag. 216

Accessori per sollevamento
Lifting accessories



Pag. 232

■ Armadi per quadri elettrici componibili CQE

CQE modular enclosure

Versione montata
Assembled version

H 1400



DIMENSIONI ARMADIO ENCLOSURE DIMENSIONS		ARMADIO SOLO STRUTTURA ENCLOSURE STRUCTURE ONLY	ARMADIO CON RETRO ENCLOSURE WITH REAR PANEL	ARMADIO CON PORTA CIECA E RETRO ENCLOSURE WITH BLANK DOOR AND REAR PANEL	ARMADIO CON PORTA TRASP. E RETRO ENCLOSURE WITH GLASS DOOR AND REAR PANEL	ARMADIO CON PORTA IN VETRO SERIGR. E RETRO SCREEN-PRINTED GLASS DOOR AND REAR PANEL ENCLOSURE
L W	P D					
600	400	R5CQE1464S	R5CQE1464R	R5CQE1464	R5CQE1464X	
	500	R5CQE1465S	R5CQE1465R	R5CQE1465	R5CQE1465X	
800	400	R5CQE1484S	R5CQE1484R	R5CQE1484	R5CQE1484X	
	500	R5CQE1485S	R5CQE1485R	R5CQE1485	R5CQE1485X	
**1200	400	R5CQE14124S	R5CQE14124R	R5CQE14124		
	500	R5CQE14125S	R5CQE14125R	R5CQE14125		
**1600	400	R5CQE14164S	R5CQE14164R	R5CQE14164		
	500	R5CQE14165S	R5CQE14165R	R5CQE14165		

* Tetto con flangia / Roof with a flange
** Armadio con doppia anta / Doble door cabinet

Accessori correlati Related accessories

Montanti
Uprights



Pag. 37

Pannelli di cablaggio
Mounting Panels



Pag. 126

Porte
Doors



Pag. 168

Retro
Rear Panel



Pag. 189

Laterali
Side panels



Pag. 191

■ Armadi per quadri elettrici componibili CQE

CQE modular enclosure

Versione montata
Assembled version

H 1400



DIMENSIONI ARMADIO ENCLOSURE DIMENSIONS		PANNELLO CABLAGGIO MOUNTING PANEL	LATERALI SIDE PANELS	ZOCOLO H.100 PLINTH H.100			ZOCOLO H.200 PLINTH H.200		
L W	P D			ANGOLARE ANGULAR	FLANGIA FRONTALE FRONT FLANGE	FLANGIA LATERALE SIDE FLANGE	ANGOLARE ANGULAR	FLANGIA FRONTALE FRONT FLANGE	FLANGIA LATERALE SIDE FLANGE
600	400	RZPCE1460	R5LE1442	R1ZCOR1	R1ZPRO601	R1ZPRO401	R1ZCOR2	R1ZPRO602	R1ZPRO402
	500					R1ZPRO501			R1ZPRO502
800	400	RZPCE1480	R5LE1442		R1ZPRO801	R1ZPRO401		R1ZPRO802	R1ZPRO402
	500		R5LE1452		R1ZPRO501	R1ZPRO502			
**1200	400	RZPCE14120	R5LE1442		R1ZPRO1201	R1ZPRO401		R1ZPRO1202	R1ZPRO402
	500		R5LE1452		R1ZPRO501	R1ZPRO502			
**1600	400	RZPCE14160	R5LE1442		R1ZPRO1601	R1ZPRO401		R1ZPRO1602	R1ZPRO402
	500		R5LE1452		R1ZPRO501	R1ZPRO502			

* Tetto con flangia / Roof with a flange
** Armadio con doppia anta / Doble door cabinet

Accessori correlati Related accessories

Zocchi
Plinth



Pag. 150

Chiusure
Locking elements



Pag. 187

Profili
Profiles



Pag. 207

Telai rack 19"
Rack 19"



Pag. 216

Accessori per sollevamento
Lifting accessories



Pag. 232

■ Armadi per quadri elettrici componibili CQE

CQE modular enclosure

Versione montata
Assembled version

H 1600



DIMENSIONI ARMADIO ENCLOSURE DIMENSIONS		ARMADIO SOLO STRUTTURA ENCLOSURE STRUCTURE ONLY	ARMADIO CON RETRO ENCLOSURE WITH REAR PANEL	ARMADIO CON PORTA CIECA E RETRO ENCLOSURE WITH BLANK DOOR AND REAR PANEL	ARMADIO CON PORTA TRASP. E RETRO ENCLOSURE WITH GLASS DOOR AND REAR PANEL	ARMADIO CON PORTA IN VETRO SERIGR. E RETRO SCREEN-PRINTED GLASS DOOR AND REAR PANEL ENCLOSURE
L W	P D					
400	400	R5CQE1644S	R5CQE1644R	R5CQE1644		
	500	R5CQE1645S	R5CQE1645R	R5CQE1645	-	-
	600	R5CQE1646S	R5CQE1646R	R5CQE1646		
600	400	R5CQE1664S	R5CQE1664R	R5CQE1664	R5CQE1664X	R5CQE1664V
	500	R5CQE1665S	R5CQE1665R	R5CQE1665	R5CQE1665X	R5CQE1665V
	600	R5CQE1666S	R5CQE1666R	R5CQE1666	R5CQE1666X	R5CQE1666V
800	400	R5CQE1684S	R5CQE1684R	R5CQE1684	R5CQE1684X	R5CQE1684V
	500	R5CQE1685S	R5CQE1685R	R5CQE1685	R5CQE1685X	R5CQE1685V
	600	R5CQE1686S	R5CQE1686R	R5CQE1686	R5CQE1686X	R5CQE1686V
1000	400	R5CQE16104S	R5CQE16104R	R5CQE16104	R5CQE16104X	
	500	R5CQE16105S	R5CQE16105R	R5CQE16105	R5CQE16105X	
	600	R5CQE16106S	R5CQE16106R	R5CQE16106	R5CQE16106X	
**1200	400	R5CQE16124S	R5CQE16124R	R5CQE16124		
	500	R5CQE16125S	R5CQE16125R	R5CQE16125	-	
	600	R5CQE16126S	R5CQE16126R	R5CQE16126		

* Tetto con flangia / Roof with a flange
** Armadio con doppia anta / Doble door cabinet

Accessori correlati Related accessories

Montanti
Uprights



Pag. 37

Pannelli di cablaggio
Mounting Panels



Pag. 126

Porte
Doors



Pag. 168

Retro
Rear Panel



Pag. 189

Laterali
Side panels



Pag. 191

■ Armadi per quadri elettrici componibili CQE

CQE modular enclosure

Versione montata
Assembled version

H 1600



DIMENSIONI ARMADIO ENCLOSURE DIMENSIONS		PANNELLO CABLAGGIO MOUNTING PANEL	LATERALI SIDE PANELS	ZOCOLO H.100 PLINTH H.100			ZOCOLO H.200 PLINTH H.200		
L W	P D			ANGOLARE ANGULAR	FLANGIA FRONTALE FRONT FLANGE	FLANGIA LATERALE SIDE FLANGE	ANGOLARE ANGULAR	FLANGIA FRONTALE FRONT FLANGE	FLANGIA LATERALE SIDE FLANGE
400	400	RZPCE1640	R5LE1642		R1ZPRO401	R1ZPRO401		R1ZPRO402	R1ZPRO402
	500		R5LE1652			R1ZPRO501			R1ZPRO502
	600		R5LE1662			R1ZPRO601			R1ZPRO602
600	400	RZPCE1660	R5LE1642		R1ZPRO601	R1ZPRO401		R1ZPRO602	R1ZPRO402
	500		R5LE1652			R1ZPRO501			R1ZPRO502
	600		R5LE1662			R1ZPRO601			R1ZPRO602
800	400	RZPCE1680	R5LE1642	R1ZCOR1	R1ZPRO801	R1ZPRO401	R1ZCOR2	R1ZPRO802	R1ZPRO402
	500		R5LE1652			R1ZPRO501			R1ZPRO502
	600		R5LE1662			R1ZPRO601			R1ZPRO602
1000	400	RZPCE16100	R5LE1642		R1ZPRO1001	R1ZPRO401		R1ZPRO1002	R1ZPRO402
	500		R5LE1652			R1ZPRO501			R1ZPRO502
	600		R5LE1662			R1ZPRO601			R1ZPRO602
**1200	400	RZPCE16120	R5LE1642		R1ZPRO1201	R1ZPRO401		R1ZPRO1202	R1ZPRO402
	500		R5LE1652			R1ZPRO501			R1ZPRO502
	600		R5LE1662			R1ZPRO601			R1ZPRO602

* Tetto con flangia / Roof with a flange
** Armadio con doppia anta / Doble door cabinet

Accessori correlati Related accessories

Zocchi
Plinth



Pag. 150

Chiusure
Locking elements



Pag. 187

Profili
Profiles



Pag. 207

Telai rack 19"
Rack 19"



Pag. 216

Accessori per sollevamento
Lifting accessories



Pag. 232

■ Armadi per quadri elettrici componibili CQE

CQE modular enclosure

Versione montata
Assembled version

H 1800



DIMENSIONI ARMADIO ENCLOSURE DIMENSIONS		ARMADIO SOLO STRUTTURA ENCLOSURE STRUCTURE ONLY	ARMADIO CON RETRO ENCLOSURE WITH REAR PANEL	ARMADIO CON PORTA CIECA E RETRO ENCLOSURE WITH BLANK DOOR AND REAR PANEL	ARMADIO CON PORTA TRASP. E RETRO ENCLOSURE WITH GLASS DOOR AND REAR PANEL	ARMADIO CON PORTA IN VETRO SERIGR. E RETRO SCREEN-PRINTED GLASS DOOR AND REAR PANEL ENCLOSURE
L W	P D					
300	300	R5CQE1833S	R5CQE1833R	R5CQE1833		
	400	R5CQE1834S	R5CQE1834R	R5CQE1834		
	500	R5CQE1835S	R5CQE1835R	R5CQE1835		
	600	R5CQE1836S	R5CQE1836R	R5CQE1836		
	800	R5CQE1838S	R5CQE1838R	R5CQE1838		
	1000	R5CQE18310S	R5CQE18310R	R5CQE18310		
400	300	R5CQE1843S	R5CQE1843R	R5CQE1843		
	400	R5CQE1844S	R5CQE1844R	R5CQE1844		
	500	R5CQE1845S	R5CQE1845R	R5CQE1845		
	600	R5CQE1846S	R5CQE1846R	R5CQE1846		
	800	R5CQE1848S	R5CQE1848R	R5CQE1848		
	1000	R5CQE18410S	R5CQE18410R	R5CQE18410		
600	300	R5CQE1863S	R5CQE1863R	R5CQE1863	R5CQE1863X	R5CQE1863V
	400	R5CQE1864S	R5CQE1864R	R5CQE1864	R5CQE1864X	R5CQE1864V
	500	R5CQE1865S	R5CQE1865R	R5CQE1865	R5CQE1865X	R5CQE1865V
	600	R5CQE1866S	R5CQE1866R	R5CQE1866	R5CQE1866X	R5CQE1866V
	800	R5CQE1868S	R5CQE1868R	R5CQE1868	R5CQE1868X	R5CQE1868V
	1000	R5CQE18610S	R5CQE18610R	R5CQE18610	R5CQE18610X	R5CQE18610V
800	300	R5CQE1883S	R5CQE1883R	R5CQE1883	R5CQE1883X	R5CQE1883V
	400	R5CQE1884S	R5CQE1884R	R5CQE1884	R5CQE1884X	R5CQE1884V
	500	R5CQE1885S	R5CQE1885R	R5CQE1885	R5CQE1885X	R5CQE1885V
	600	R5CQE1886S	R5CQE1886R	R5CQE1886	R5CQE1886X	R5CQE1886V

* Tetto con flangia / Roof with a flange
** Armadio con doppia anta / Doble door cabinet

Accessori correlati Related accessories

Montanti
Uprights



Pag. 37

Pannelli di cablaggio
Mounting Panels



Pag. 126

Porte
Doors



Pag. 168

Retro
Rear Panel



Pag. 189

Laterali
Side panels



Pag. 191

■ Armadi per quadri elettrici componibili CQE

CQE modular enclosure

Versione montata
Assembled version

H 1800



DIMENSIONI ARMADIO ENCLOSURE DIMENSIONS		PANNELLO CABLAGGIO MOUNTING PANEL	LATERALI SIDE PANELS	ZOCOLO H.100 PLINTH H.100			ZOCOLO H.200 PLINTH H.200			
L W	P D			ANGOLARE ANGULAR	FLANGIA FRONTALE FRONT FLANGE	FLANGIA LATERALE SIDE FLANGE	ANGOLARE ANGULAR	FLANGIA FRONTALE FRONT FLANGE	FLANGIA LATERALE SIDE FLANGE	
300	300	RZPCE1830			R1ZPRO301	R1ZPRO301	R1ZPRO302	R1ZPRO302		
	400					R1ZPRO401				R1ZPRO402
	500					R1ZPRO501				R1ZPRO502
	600					R1ZPRO601				R1ZPRO602
	800					R1ZPRO801				R1ZPRO802
	1000				R1ZPRO1001		R1ZPRO1002			
400	300	RZPCE1840		R1ZCOR1	R1ZPRO401	R1ZPRO301	R1ZCOR2	R1ZPRO402		
	400					R1ZPRO401				R1ZPRO402
	500					R1ZPRO501				R1ZPRO502
	600					R1ZPRO601				R1ZPRO602
	800					R1ZPRO801				R1ZPRO802
	1000				R1ZPRO1001		R1ZPRO1002			
600	300	RZPCE1860			R1ZPRO601	R1ZPRO301	R1ZPRO602	R1ZPRO602		
	400					R1ZPRO401				R1ZPRO402
	500					R1ZPRO501				R1ZPRO502
	600					R1ZPRO601				R1ZPRO602
	800					R1ZPRO801				R1ZPRO802
	1000				R1ZPRO1001		R1ZPRO1002			
800	300	RZPCE1880			R1ZPRO801	R1ZPRO301	R1ZPRO802	R1ZPRO802		
	400					R1ZPRO401				R1ZPRO402
	500					R1ZPRO501				R1ZPRO502
	600					R1ZPRO601				R1ZPRO602

* Tetto con flangia / Roof with a flange
** Armadio con doppia anta / Doble door cabinet

Accessori correlati Related accessories

Zocchi
Plinth

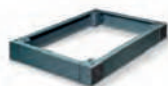

Pag. 150

Chiusure
Locking elements



Pag. 187

Profili
Profiles



Pag. 207

Telai rack 19"
Rack 19"



Pag. 216

Accessori per sollevamento
Lifting accessories



Pag. 232

■ Armadi per quadri elettrici componibili CQE

CQE modular enclosure

Versione montata
Assembled version

H 1800



DIMENSIONI ARMADIO ENCLOSURE DIMENSIONS		ARMADIO SOLO STRUTTURA ENCLOSURE STRUCTURE ONLY	ARMADIO CON RETRO ENCLOSURE WITH REAR PANEL	ARMADIO CON PORTA CIECA E RETRO ENCLOSURE WITH BLANK DOOR AND REAR PANEL	ARMADIO CON PORTA TRASP. E RETRO ENCLOSURE WITH GLASS DOOR AND REAR PANEL	ARMADIO CON PORTA IN VETRO SERIGR. E RETRO SCREEN-PRINTED GLASS DOOR AND REAR PANEL ENCLOSURE
L W	P D					
800	800	R5CQE1888S	R5CQE1888R	R5CQE1888	R5CQE1888X	R5CQE1888V
	1000	R5CQE18810S	R5CQE18810R	R5CQE18810	R5CQE18810X	R5CQE18810V
1000	400	R5CQE18104S	R5CQE18104R	R5CQE18104	R5CQE18104X	
	500	R5CQE18105S	R5CQE18105R	R5CQE18105	R5CQE18105X	
	600	R5CQE18106S	R5CQE18106R	R5CQE18106	R5CQE18106X	
	800	R5CQE18108S	R5CQE18108R	R5CQE18108	R5CQE18108X	
	1000	R5CQE181010S	R5CQE181010R	R5CQE181010	R5CQE181010X	
**1200	400	R5CQE18124S	R5CQE18124R	R5CQE18124	R5CQE18124X	
	500	R5CQE18125S	R5CQE18125R	R5CQE18125	R5CQE18125X	
	600	R5CQE18126S	R5CQE18126R	R5CQE18126	R5CQE18126X	
	800	R5CQE18128S	R5CQE18128R	R5CQE18128	R5CQE18128X	
	1000	R5CQE181210S	R5CQE181210R	R5CQE181210	R5CQE181210X	

* Tetto con flangia / Roof with a flange
** Armadio con doppia anta / Doble door cabinet

Accessori correlati Related accessories

Montanti
Uprights



Pag. 37

Pannelli di cablaggio
Mounting Panels



Pag. 126

Porte
Doors



Pag. 168

Retro
Rear Panel



Pag. 189

Laterali
Side panels



Pag. 191

■ Armadi per quadri elettrici componibili CQE

CQE modular enclosure

Versione montata
Assembled version

H 1800



DIMENSIONI ARMADIO ENCLOSURE DIMENSIONS		PANNELLO CABLAGGIO MOUNTING PANEL	LATERALI SIDE PANELS	ZOCOLO H.100 PLINTH H.100			ZOCOLO H.200 PLINTH H.200		
L W	P D			ANGOLARE ANGULAR	FLANGIA FRONTALE FRONT FLANGE	FLANGIA LATERALE SIDE FLANGE	ANGOLARE ANGULAR	FLANGIA FRONTALE FRONT FLANGE	FLANGIA LATERALE SIDE FLANGE
800	800	RZPCE1880	R5LE1882	R1ZCOR1	R1ZPRO801	R1ZPRO801	R1ZCOR2	R1ZPRO802	R1ZPRO802
	1000		R5LE18102			R1ZPRO1001			R1ZPRO1002
1000	400	RZPCE18100	R5LE1842		R1ZPRO1001	R1ZPRO401		R1ZPRO1002	R1ZPRO402
	500		R5LE1852			R1ZPRO501			R1ZPRO502
	600		R5LE1862			R1ZPRO601			R1ZPRO602
	800		R5LE1882			R1ZPRO801			R1ZPRO802
	1000		R5LE18102			R1ZPRO1001			R1ZPRO1002
**1200	400	RZPCE18120	R5LE1842		R1ZPRO1201	R1ZPRO401		R1ZPRO1202	R1ZPRO402
	500		R5LE1852			R1ZPRO501			R1ZPRO502
	600		R5LE1862			R1ZPRO601			R1ZPRO602
	800		R5LE1882	R1ZPRO801		R1ZPRO802			
	1000		R5LE18102		R1ZPRO1001		R1ZPRO1002		

* Tetto con flangia / Roof with a flange
** Armadio con doppia anta / Doble door cabinet

Accessori correlati Related accessories

Zocchi
Plinth

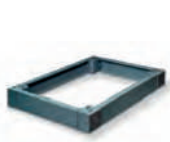

Pag. 150

Chiusure
Locking elements



Pag. 187

Profili
Profiles



Pag. 207

Telai rack 19"
Rack 19"



Pag. 216

Accessori per sollevamento
Lifting accessories



Pag. 232

■ Armadi per quadri elettrici componibili CQE

CQE modular enclosure

Versione montata
Assembled version

H 2000



DIMENSIONI ARMADIO ENCLOSURE DIMENSIONS		ARMADIO SOLO STRUTTURA ENCLOSURE STRUCTURE ONLY	ARMADIO CON RETRO ENCLOSURE WITH REAR PANEL	ARMADIO CON PORTA CIECA E RETRO ENCLOSURE WITH BLANK DOOR AND REAR PANEL	ARMADIO CON PORTA TRASP. E RETRO ENCLOSURE WITH GLASS DOOR AND REAR PANEL	ARMADIO CON PORTA IN VETRO SERIGR. E RETRO SCREEN-PRINTED GLASS DOOR AND REAR PANEL ENCLOSURE
L W	P D					
300	300	R5CQE2033S	R5CQE2033R	R5CQE2033		
	400	R5CQE2034S	R5CQE2034R	R5CQE2034		
	500	R5CQE2035S	R5CQE2035R	R5CQE2035		
	600	R5CQE2036S	R5CQE2036R	R5CQE2036		
	800	R5CQE2038S	R5CQE2038R	R5CQE2038		
	1000	R5CQE20310S	R5CQE20310R	R5CQE20310		
400	300	R5CQE2043S	R5CQE2043R	R5CQE2043		
	400	R5CQE2044S	R5CQE2044R	R5CQE2044		
	500	R5CQE2045S	R5CQE2045R	R5CQE2045		
	600	R5CQE2046S	R5CQE2046R	R5CQE2046		
	800	R5CQE2048S	R5CQE2048R	R5CQE2048		
	1000	R5CQE20410S	R5CQE20410R	R5CQE20410		
600	300	R5CQE2063S	R5CQE2063R	R5CQE2063	R5CQE2063X	R5CQE2063V
	400	R5CQE2064S	R5CQE2064R	R5CQE2064	R5CQE2064X	R5CQE2064V
	500	R5CQE2065S	R5CQE2065R	R5CQE2065	R5CQE2065X	R5CQE2065V
	600	R5CQE2066S	R5CQE2066R	R5CQE2066	R5CQE2066X	R5CQE2066V
	800	R5CQE2068S	R5CQE2068R	R5CQE2068	R5CQE2068X	R5CQE2068V
	1000	R5CQE20610S	R5CQE20610R	R5CQE20610	R5CQE20610X	R5CQE20610V
800	300	R5CQE2083S	R5CQE2083R	R5CQE2083	R5CQE2083X	R5CQE2083V
	400	R5CQE2084S	R5CQE2084R	R5CQE2084	R5CQE2084X	R5CQE2084V
	500	R5CQE2085S	R5CQE2085R	R5CQE2085	R5CQE2085X	R5CQE2085V
	600	R5CQE2086S	R5CQE2086R	R5CQE2086	R5CQE2086X	R5CQE2086V
	800	R5CQE2088S	R5CQE2088R	R5CQE2088	R5CQE2088X	R5CQE2088V
	1000	R5CQE20810S	R5CQE20810R	R5CQE20810	R5CQE20810X	R5CQE20810V
1000	400	R5CQE20104S	R5CQE20104R	R5CQE20104	R5CQE20104X	
	500	R5CQE20105S	R5CQE20105R	R5CQE20105	R5CQE20105X	
	600	R5CQE20106S	R5CQE20106R	R5CQE20106	R5CQE20106X	
	800	R5CQE20108S	R5CQE20108R	R5CQE20108	R5CQE20108X	
	1000	R5CQE201010S	R5CQE201010R	R5CQE201010	R5CQE201010X	
**1200	400	R5CQE20124S	R5CQE20124R	R5CQE20124	R5CQE20124X	
	500	R5CQE20125S	R5CQE20125R	R5CQE20125	R5CQE20125X	
	600	R5CQE20126S	R5CQE20126R	R5CQE20126	R5CQE20126X	

* Tetto con flangia / Roof with a flange
** Armadio con doppia anta / Doble door cabinet

Accessori correlati Related accessories

Montanti
Uprights



Pag. 37

Pannelli di cablaggio
Mounting Panels



Pag. 126

Porte
Doors



Pag. 168

Retro
Rear Panel



Pag. 189

Laterali
Side panels



Pag. 191

■ Armadi per quadri elettrici componibili CQE

CQE modular enclosure

Versione montata
Assembled version

H 2000



DIMENSIONI ARMADIO ENCLOSURE DIMENSIONS		PANNELLO CABLAGGIO MOUNTING PANEL	LATERALI SIDE PANELS	ZOCOLO H.100 PLINTH H.100			ZOCOLO H.200 PLINTH H.200		
L W	P D			ANGOLARE ANGULAR	FLANGIA FRONTALE FRONT FLANGE	FLANGIA LATERALE SIDE FLANGE	ANGOLARE ANGULAR	FLANGIA FRONTALE FRONT FLANGE	FLANGIA LATERALE SIDE FLANGE
300	300	RZPCE2030	R5LE2032	R1ZCOR1	R1ZPRO301	R1ZPRO301	R1ZCOR2	R1ZPRO302	R1ZPRO302
	400		R5LE2042			R1ZPRO401			R1ZPRO402
	500		R5LE2052			R1ZPRO501			R1ZPRO502
	600		R5LE2062			R1ZPRO601			R1ZPRO602
	800		R5LE2082			R1ZPRO801			R1ZPRO802
	1000		R5LE20102			R1ZPRO1001			R1ZPRO1002
400	300	RZPCE2040	R5LE2032	R1ZCOR1	R1ZPRO401	R1ZPRO301	R1ZCOR2	R1ZPRO402	R1ZPRO302
	400		R5LE2042			R1ZPRO401			R1ZPRO402
	500		R5LE2052			R1ZPRO501			R1ZPRO502
	600		R5LE2062			R1ZPRO601			R1ZPRO602
	800		R5LE2082			R1ZPRO801			R1ZPRO802
	1000		R5LE20102			R1ZPRO1001			R1ZPRO1002
600	300	RZPCE2060	R5LE2032	R1ZCOR1	R1ZPRO601	R1ZPRO301	R1ZCOR2	R1ZPRO602	R1ZPRO302
	400		R5LE2042			R1ZPRO401			R1ZPRO402
	500		R5LE2052			R1ZPRO501			R1ZPRO502
	600		R5LE2062			R1ZPRO601			R1ZPRO602
	800		R5LE2082			R1ZPRO801			R1ZPRO802
	1000		R5LE20102			R1ZPRO1001			R1ZPRO1002
800	300	RZPCE2080	R5LE2032	R1ZCOR1	R1ZPRO801	R1ZPRO301	R1ZCOR2	R1ZPRO802	R1ZPRO302
	400		R5LE2042			R1ZPRO401			R1ZPRO402
	500		R5LE2052			R1ZPRO501			R1ZPRO502
	600		R5LE2062			R1ZPRO601			R1ZPRO602
	800		R5LE2082			R1ZPRO801			R1ZPRO802
	1000		R5LE20102			R1ZPRO1001			R1ZPRO1002
1000	400	RZPCE20100	R5LE2042	R1ZCOR1	R1ZPRO1001	R1ZPRO401	R1ZCOR2	R1ZPRO1002	R1ZPRO402
	500		R5LE2052			R1ZPRO501			R1ZPRO502
	600		R5LE2062			R1ZPRO601			R1ZPRO602
	800		R5LE2082			R1ZPRO801			R1ZPRO802
	1000		R5LE20102			R1ZPRO1001			R1ZPRO1002
	1000		R5LE20102			R1ZPRO1001			R1ZPRO1002
**1200	400	RZPCE20120	R5LE2042	R1ZCOR1	R1ZPRO1201	R1ZPRO401	R1ZCOR2	R1ZPRO1202	R1ZPRO402
	500		R5LE2052			R1ZPRO501			R1ZPRO502
	600		R5LE2062			R1ZPRO601			R1ZPRO602

* Tetto con flangia / Roof with a flange
** Armadio con doppia anta / Doble door cabinet

Accessori correlati Related accessories

Zocchi
Plinth

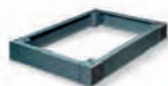

Pag. 150

Chiusure
Locking elements



Pag. 187

Profili
Profiles



Pag. 207

Telai rack 19"
Rack 19"



Pag. 216

Accessori per sollevamento
Lifting accessories



Pag. 232

■ Armadi per quadri elettrici componibili CQE

CQE modular enclosure

Versione montata
Assembled version

H 2000



DIMENSIONI ARMADIO ENCLOSURE DIMENSIONS		ARMADIO SOLO STRUTTURA ENCLOSURE STRUCTURE ONLY	ARMADIO CON RETRO ENCLOSURE WITH REAR PANEL	ARMADIO CON PORTA CIECA E RETRO ENCLOSURE WITH BLANK DOOR AND REAR PANEL	ARMADIO CON PORTA TRASP. E RETRO ENCLOSURE WITH GLASS DOOR AND REAR PANEL	ARMADIO CON PORTA IN VETRO SERIGR. E RETRO SCREEN-PRINTED GLASS DOOR AND REAR PANEL ENCLOSURE
L W	P D					
**1200	800	R5CQE20128S	R5CQE20128R	R5CQE20128	R5CQE20128X	
	1000	R5CQE201210S	R5CQE201210R	R5CQE201210	R5CQE201210X	
**1400	400	R5CQE20144S	R5CQE20144R	R5CQE20144		
	500	R5CQE20145S	R5CQE20145R	R5CQE20145		
	600	R5CQE20146S	R5CQE20146R	R5CQE20146		
	800	R5CQE20148S	R5CQE20148R	R5CQE20148		
	1000	R5CQE201410S	R5CQE201410R	R5CQE201410		
**1600	400	R5CQE20164S	R5CQE20164R	R5CQE20164		
	500	R5CQE20165S	R5CQE20165R	R5CQE20165		
	600	R5CQE20166S	R5CQE20166R	R5CQE20166		
	800	R5CQE20168S	R5CQE20168R	R5CQE20168		
	1000	R5CQE201610S	R5CQE201610R	R5CQE201610		

* Tetto con flangia / Roof with a flange
** Armadio con doppia anta / Doble door cabinet

Accessori correlati Related accessories

Montanti
Uprights



Pag. 37

Pannelli di cablaggio
Mounting Panels



Pag. 126

Porte
Doors



Pag. 168

Retro
Rear Panel



Pag. 189

Laterali
Side panels



Pag. 191

■ Armadi per quadri elettrici componibili CQE

CQE modular enclosure

Versione montata
Assembled version

H 2000



DIMENSIONI ARMADIO ENCLOSURE DIMENSIONS		PANNELLO CABLAGGIO MOUNTING PANEL	LATERALI SIDE PANELS	ZOCOLO H.100 PLINTH H.100			ZOCOLO H.200 PLINTH H.200		
L W	P D			ANGOLARE ANGULAR	FLANGIA FRONTALE FRONT FLANGE	FLANGIA LATERALE SIDE FLANGE	ANGOLARE ANGULAR	FLANGIA FRONTALE FRONT FLANGE	FLANGIA LATERALE SIDE FLANGE
**1200	800	RZPCE20120	R5LE2082	R1ZCOR1	R1ZPRO1201	R1ZPRO801	R1ZCOR2	R1ZPRO1202	R1ZPRO802
	1000		R5LE20102			R1ZPRO1001			R1ZPRO1002
	400		R5LE2042			R1ZPRO401			R1ZPRO402
**1400	500	RZPCE20140	R5LE2052		R1ZPRO1401	R1ZPRO501		R1ZPRO1402	R1ZPRO502
	600		R5LE2062			R1ZPRO601			R1ZPRO602
	800		R5LE2082			R1ZPRO801			R1ZPRO802
	1000		R5LE20102			R1ZPRO1001			R1ZPRO1002
	400		R5LE2042			R1ZPRO401			R1ZPRO402
**1600	500	RZPCE20160	R5LE2052		R1ZPRO1601	R1ZPRO501		R1ZPRO1602	R1ZPRO502
	600		R5LE2062			R1ZPRO601			R1ZPRO602
	800		R5LE2082			R1ZPRO801			R1ZPRO802
	1000		R5LE20102			R1ZPRO1001			R1ZPRO1002

* Tetto con flangia / Roof with a flange
** Armadio con doppia anta / Doble door cabinet

Accessori correlati Related accessories

Zocchi
Plinth

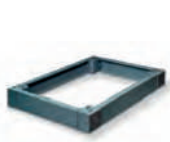

Pag. 150

Chiusure
Locking elements



Pag. 187

Profili
Profiles



Pag. 207

Telai rack 19"
Rack 19"



Pag. 216

Accessori per sollevamento
Lifting accessories



Pag. 232

■ Armadi per quadri elettrici componibili CQE

CQE modular enclosure

Versione montata
Assembled version

H 2200



DIMENSIONI ARMADIO ENCLOSURE DIMENSIONS		ARMADIO SOLO STRUTTURA ENCLOSURE STRUCTURE ONLY	ARMADIO CON RETRO ENCLOSURE WITH REAR PANEL	ARMADIO CON PORTA CIECA E RETRO ENCLOSURE WITH BLANK DOOR AND REAR PANEL	ARMADIO CON PORTA TRASP. E RETRO ENCLOSURE WITH GLASS DOOR AND REAR PANEL	ARMADIO CON PORTA IN VETRO SERIGR. E RETRO SCREEN-PRINTED GLASS DOOR AND REAR PANEL ENCLOSURE
L W	P D					
300	300	R5CQE2233S	R5CQE2233R	R5CQE2233		
	400	R5CQE2234S	R5CQE2234R	R5CQE2234		
	500	R5CQE2235S	R5CQE2235R	R5CQE2235		
	600	R5CQE2236S	R5CQE2236R	R5CQE2236		
	800	R5CQE2238S	R5CQE2238R	R5CQE2238		
	1000	R5CQE22310S	R5CQE22310R	R5CQE22310		
400	300	R5CQE2243S	R5CQE2243R	R5CQE2243		
	400	R5CQE2244S	R5CQE2244R	R5CQE2244		
	500	R5CQE2245S	R5CQE2245R	R5CQE2245		
	600	R5CQE2246S	R5CQE2246R	R5CQE2246		
	800	R5CQE2248S	R5CQE2248R	R5CQE2248		
	1000	R5CQE22410S	R5CQE22410R	R5CQE22410		
600	300	R5CQE2263S	R5CQE2263R	R5CQE2263	R5CQE2263X	
	400	R5CQE2264S	R5CQE2264R	R5CQE2264	R5CQE2264X	
	500	R5CQE2265S	R5CQE2265R	R5CQE2265	R5CQE2265X	
	600	R5CQE2266S	R5CQE2266R	R5CQE2266	R5CQE2266X	
	800	R5CQE2268S	R5CQE2268R	R5CQE2268	R5CQE2268X	
	1000	R5CQE22610S	R5CQE22610R	R5CQE22610	R5CQE22610X	
800	300	R5CQE2283S	R5CQE2283R	R5CQE2283	R5CQE2283X	
	400	R5CQE2284S	R5CQE2284R	R5CQE2284	R5CQE2284X	
	500	R5CQE2285S	R5CQE2285R	R5CQE2285	R5CQE2285X	
	600	R5CQE2286S	R5CQE2286R	R5CQE2286	R5CQE2286X	

* Tetto con flangia / Roof with a flange
** Armadio con doppia anta / Doble door cabinet

Accessori correlati Related accessories

Montanti
Uprights



Pag. 37

Pannelli di cablaggio
Mounting Panels



Pag. 126

Porte
Doors



Pag. 168

Retro
Rear Panel



Pag. 189

Laterali
Side panels



Pag. 191

■ Armadi per quadri elettrici componibili CQE

CQE modular enclosure

Versione montata
Assembled version

H 2200



DIMENSIONI ARMADIO ENCLOSURE DIMENSIONS		PANNELLO CABLAGGIO MOUNTING PANEL	LATERALI SIDE PANELS	ZOCOLO H.100 PLINTH H.100			ZOCOLO H.200 PLINTH H.200		
L W	P D			ANGOLARE ANGULAR	FLANGIA FRONTALE FRONT FLANGE	FLANGIA LATERALE SIDE FLANGE	ANGOLARE ANGULAR	FLANGIA FRONTALE FRONT FLANGE	FLANGIA LATERALE SIDE FLANGE
300	300	RZPCE2230	R5LE2232	R1ZCOR1	R1ZPRO301	R1ZPRO301	R1ZCOR2	R1ZPRO302	R1ZPRO302
	400		R5LE2242			R1ZPRO401			R1ZPRO402
	500		R5LE2252			R1ZPRO501			R1ZPRO502
	600		R5LE2262			R1ZPRO601			R1ZPRO602
	800		R5LE2282			R1ZPRO801			R1ZPRO802
	1000		R5LE22102			R1ZPRO1001			R1ZPRO1002
400	300	RZPCE2240	R5LE2232	R1ZCOR1	R1ZPRO401	R1ZPRO301	R1ZCOR2	R1ZPRO402	R1ZPRO302
	400		R5LE2242			R1ZPRO401			R1ZPRO402
	500		R5LE2252			R1ZPRO501			R1ZPRO502
	600		R5LE2262			R1ZPRO601			R1ZPRO602
	800		R5LE2282			R1ZPRO801			R1ZPRO802
	1000		R5LE22102			R1ZPRO1001			R1ZPRO1002
600	300	RZPCE2260	R5LE2232	R1ZCOR1	R1ZPRO601	R1ZPRO301	R1ZCOR2	R1ZPRO602	R1ZPRO302
	400		R5LE2242			R1ZPRO401			R1ZPRO402
	500		R5LE2252			R1ZPRO501			R1ZPRO502
	600		R5LE2262			R1ZPRO601			R1ZPRO602
	800		R5LE2282			R1ZPRO801			R1ZPRO802
	1000		R5LE22102			R1ZPRO1001			R1ZPRO1002
800	300	RZPCE2280	R5LE2232	R1ZCOR1	R1ZPRO801	R1ZPRO301	R1ZCOR2	R1ZPRO802	R1ZPRO302
	400		R5LE2242			R1ZPRO401			R1ZPRO402
	500		R5LE2252			R1ZPRO501			R1ZPRO502
	600		R5LE2262			R1ZPRO601			R1ZPRO602

* Tetto con flangia / Roof with a flange
** Armadio con doppia anta / Doble door cabinet

Accessori correlati Related accessories

Zocchi
Plinth



Pag. 150

Chiusure
Locking elements



Pag. 187

Profili
Profiles



Pag. 207

Telai rack 19"
Rack 19"



Pag. 216

Accessori per sollevamento
Lifting accessories



Pag. 232

■ Armadi per quadri elettrici componibili CQE

CQE modular enclosure

Versione montata
Assembled version

H 2200



DIMENSIONI ARMADIO ENCLOSURE DIMENSIONS		ARMADIO SOLO STRUTTURA ENCLOSURE STRUCTURE ONLY	ARMADIO CON RETRO ENCLOSURE WITH REAR PANEL	ARMADIO CON PORTA CIECA E RETRO ENCLOSURE WITH BLANK DOOR AND REAR PANEL	ARMADIO CON PORTA TRASP. E RETRO ENCLOSURE WITH GLASS DOOR AND REAR PANEL	ARMADIO CON PORTA IN VETRO SERIGR. E RETRO SCREEN-PRINTED GLASS DOOR AND REAR PANEL ENCLOSURE
L W	P D					
800	800	R5CQE2288S	R5CQE2288R	R5CQE2288	R5CQE2288X	
	1000	R5CQE22810S	R5CQE22810R	R5CQE22810	R5CQE22810X	
1000	400	R5CQE22104S	R5CQE22104R	R5CQE22104	R5CQE22104X	
	500	R5CQE22105S	R5CQE22105R	R5CQE22105	R5CQE22105X	
	600	R5CQE22106S	R5CQE22106R	R5CQE22106	R5CQE22106X	
	800	R5CQE22108S	R5CQE22108R	R5CQE22108	R5CQE22108X	
	1000	R5CQE221010S	R5CQE221010R	R5CQE221010	R5CQE221010X	
**1200	400	R5CQE22124S	R5CQE22124R	R5CQE22124	R5CQE22124X	
	500	R5CQE22125S	R5CQE22125R	R5CQE22125	R5CQE22125X	
	600	R5CQE22126S	R5CQE22126R	R5CQE22126	R5CQE22126X	
	800	R5CQE22128S	R5CQE22128R	R5CQE22128	R5CQE22128X	
	1000	R5CQE221210S	R5CQE221210R	R5CQE221210	R5CQE221210X	

* Tetto con flangia / Roof with a flange
** Armadio con doppia anta / Doble door cabinet

Accessori correlati Related accessories

Montanti
Uprights



Pag. 37

Pannelli di cablaggio
Mounting Panels



Pag. 126

Porte
Doors



Pag. 168

Retro
Rear Panel



Pag. 189

Laterali
Side panels



Pag. 191

■ Armadi per quadri elettrici componibili CQE

CQE modular enclosure

Versione montata
Assembled version

H 2200



DIMENSIONI ARMADIO ENCLOSURE DIMENSIONS		PANNELLO CABLAGGIO MOUNTING PANEL	LATERALI SIDE PANELS	ZOCOLO H.100 PLINTH H.100			ZOCOLO H.200 PLINTH H.200		
L W	P D			ANGOLARE ANGULAR	FLANGIA FRONTALE FRONT FLANGE	FLANGIA LATERALE SIDE FLANGE	ANGOLARE ANGULAR	FLANGIA FRONTALE FRONT FLANGE	FLANGIA LATERALE SIDE FLANGE
800	800	RZPCE2280	R5LE2282	R1ZCOR1	R1ZPRO801	R1ZPRO801	R1ZCOR2	R1ZPRO802	R1ZPRO802
	1000		R5LE22102			R1ZPRO1001			R1ZPRO1002
1000	400	RZPCE22100	R5LE2242		R1ZPRO401	R1ZPRO402			
	500		R5LE2252		R1ZPRO501	R1ZPRO502			
	600		R5LE2262		R1ZPRO601	R1ZPRO602			
	800		R5LE2282		R1ZPRO801	R1ZPRO802			
	1000		R5LE22102		R1ZPRO1001	R1ZPRO1002			
**1200	400	RZPCE22120	R5LE2242		R1ZPRO401	R1ZPRO402			
	500		R5LE2252		R1ZPRO501	R1ZPRO502			
	600		R5LE2262		R1ZPRO601	R1ZPRO602			
	800	R5LE2282	R1ZPRO801	R1ZPRO802					
	1000	R5LE22102	R1ZPRO1001	R1ZPRO1002					

* Tetto con flangia / Roof with a flange
** Armadio con doppia anta / Doble door cabinet

Accessori correlati Related accessories

Zocchi
Plinth

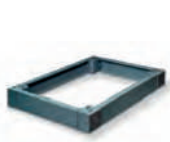

Pag. 150

Chiusure
Locking elements



Pag. 187

Profili
Profiles



Pag. 207

Telai rack 19"
Rack 19"



Pag. 216

Accessori per sollevamento
Lifting accessories



Pag. 232

■ Armadi per quadri elettrici componibili CQE

CQE modular enclosure

Versione in kit
Kit version

H 1200



DIMENSIONI ARMADIO ENCLOSURE DIMENSIONS		TETTO E BASE ROOF AND BASE	MONTANTI UPRIGHTS	PANNELLO CABLAGGIO MOUNTING PANEL	PORTA CIECA BLANK DOOR	PORTA CIECA BLANK DOOR	RETRO REAR PANEL	LATERALI SIDE PANELS
LARGHEZZA WIDTH	PROFONDITÀ DEPTH							
400	400	R1KTB44	R5KMN12	RZPCE1240	R5CPE1240	R5CRE1240	R5LE1242	
	500	R1KTB45					R5LE1252	
	600	R1KTB46					R5LE1262	
600	400	R1KTB64		R5LE1242				
	500	R1KTB65		R5LE1252				
	600	R1KTB66		R5LE1262				
800	400	R1KTB84		R5LE1242				
	500	R1KTB85		R5LE1252				
	600	R1KTB86		R5LE1262				
1000	400	R1KTB104		R5LE1242				
	500	R1KTB105		R5LE1252				
	600	R1KTB106		R5LE1262				
**1200	400	R1KTB124		R5LE1242				
	500	R1KTB125		R5LE1252				
	600	R1KTB126		R5LE1262				

* Tetto con flangia / Roof with a flange
** Armadio con doppia anta / Doble door cabinet

■ Armadi per quadri elettrici componibili CQE

CQE modular enclosure

Versione in kit
Kit version

H 1200



DIMENSIONI ARMADIO ENCLOSURE DIMENSIONS		ZOCCOLO H.100 PLINTH H.100			ZOCCOLO H.200 PLINTH H.200		
LARGHEZZA WIDTH	PROFONDITÀ DEPTH	ANGOLARE ANGULAR	FLANGIA FRONTALE FRONT FLANGE	FLANGIA LATERALE SIDE FLANGE	ANGOLARE ANGULAR	FLANGIA FRONTALE FRONT FLANGE	FLANGIA LATERALE SIDE FLANGE
	400			R1ZPRO401			R1ZPRO402
400	500		R1ZPRO401	R1ZPRO501		R1ZPRO402	R1ZPRO502
	600			R1ZPRO601			R1ZPRO602
	400			R1ZPRO401			R1ZPRO402
600	500		R1ZPRO601	R1ZPRO501		R1ZPRO602	R1ZPRO502
	600			R1ZPRO601			R1ZPRO602
	400			R1ZPRO401			R1ZPRO402
800	500	R1ZCOR1	R1ZPRO801	R1ZPRO501	R1ZCOR2	R1ZPRO802	R1ZPRO502
	600			R1ZPRO601			R1ZPRO602
	400			R1ZPRO401			R1ZPRO402
1000	500		R1ZPRO1001	R1ZPRO501		R1ZPRO1002	R1ZPRO502
	600			R1ZPRO601			R1ZPRO602
	400			R1ZPRO401			R1ZPRO402
**1200	500		R1ZPRO1201	R1ZPRO501		R1ZPRO1202	R1ZPRO502
	600			R1ZPRO601			R1ZPRO602

* Tetto con flangia / Roof with a flange
** Armadio con doppia anta / Doble door cabinet

■ Armadi per quadri elettrici componibili CQE

CQE modular enclosure

Versione in kit
Kit version

H 1400



DIMENSIONI ARMADIO ENCLOSURE DIMENSIONS		TETTO E BASE ROOF AND BASE	MONTANTI UPRIGHTS	PANNELLO CABLAGGIO MOUNTING PANEL	PORTA CIECA BLANK DOOR	PORTA CIECA BLANK DOOR	RETRO REAR PANEL	LATERALI SIDE PANELS
LARGHEZZA WIDTH	PROFONDITÀ DEPTH							
600	400	R1KTB64	R5KMN14	RZPCE1460	R5CPE1460		R5CRE1460	R5LE1442
	500	R1KTB65						R5LE1452
800	400	R1KTB84		RZPCE1480	R5CPE1480		R5CRE1480	R5LE1442
	500	R1KTB85						R5LE1452
**1200	400	R1KTB124		RZPCE14120		R5CPE14120	R5CRE14120	R5LE1442
	500	R1KTB125						R5LE1452
**1600	400	R1KTB164		RZPCE14160		R5CPE14160	R5CRE14160	R5LE1442
	500	R1KTB165						R5LE1452

* Tetto con flangia / Roof with a flange
** Armadio con doppia anta / Doble door cabinet

■ Armadi per quadri elettrici componibili CQE

CQE modular enclosure

Versione in kit
Kit version

H 1400



DIMENSIONI ARMADIO ENCLOSURE DIMENSIONS		ZOCOLO H.100 PLINTH H.100			ZOCOLO H.200 PLINTH H.200		
LARGHEZZA WIDTH	PROFONDITÀ DEPTH	ANGOLARE ANGULAR	FLANGIA FRONTALE FRONT FLANGE	FLANGIA LATERALE SIDE FLANGE	ANGOLARE ANGULAR	FLANGIA FRONTALE FRONT FLANGE	FLANGIA LATERALE SIDE FLANGE
600	400	R1ZCOR1	R1ZPRO601	R1ZPRO401	R1ZCOR2	R1ZPRO602	R1ZPRO402
	500			R1ZPRO501			R1ZPRO502
800	400		R1ZPRO801	R1ZPRO401		R1ZPRO802	R1ZPRO402
	500		R1ZPRO501	R1ZPRO502			
**1200	400		R1ZPRO1201	R1ZPRO401		R1ZPRO1202	R1ZPRO402
	500		R1ZPRO501	R1ZPRO502			
**1600	400		R1ZPRO1601	R1ZPRO401		R1ZPRO1602	R1ZPRO402
	500		R1ZPRO501	R1ZPRO502			

* Tetto con flangia / Roof with a flange
** Armadio con doppia anta / Doble door cabinet

■ Armadi per quadri elettrici componibili CQE

CQE modular enclosure

Versione in kit
Kit version

H 1600



DIMENSIONI ARMADIO ENCLOSURE DIMENSIONS		TETTO E BASE ROOF AND BASE	MONTANTI UPRIGHTS	PANNELLO CABLAGGIO MOUNTING PANEL	PORTA CIECA BLANK DOOR	PORTA CIECA BLANK DOOR	RETRO REAR PANEL	LATERALI SIDE PANELS
LARGHEZZA WIDTH	PROFONDITÀ DEPTH							
400	400	R1KTB44	R5KMN16					R5LE1642
	500	R1KTB45		RZPCE1640	R5CPE1640		R5CRE1640	R5LE1652
	600	R1KTB46						R5LE1662
600	400	R1KTB64						R5LE1642
	500	R1KTB65		RZPCE1660	R5CPE1660		R5CRE1660	R5LE1652
	600	R1KTB66						R5LE1662
800	400	R1KTB84						R5LE1642
	500	R1KTB85		RZPCE1680	R5CPE1680		R5CRE1680	R5LE1652
	600	R1KTB86						R5LE1662
1000	400	R1KTB104						R5LE1642
	500	R1KTB105		RZPCE16100	R5CPE16100		R5CRE16100	R5LE1652
	600	R1KTB106						R5LE1662
**1200	400	R1KTB124					R5LE1642	
	500	R1KTB125	RZPCE16120	-	R5CPE16120	R5CRE16120	R5LE1652	
	600	R1KTB126					R5LE1662	

* Tetto con flangia / Roof with a flange
** Armadio con doppia anta / Doble door cabinet

■ Armadi per quadri elettrici componibili CQE

CQE modular enclosure

Versione in kit
Kit version

H 1600



DIMENSIONI ARMADIO ENCLOSURE DIMENSIONS		ZOCOLO H.100 PLINTH H.100			ZOCOLO H.200 PLINTH H.200			
LARGHEZZA WIDTH	PROFONDITÀ DEPTH	ANGOLARE ANGULAR	FLANGIA FRONTALE FRONT FLANGE	FLANGIA LATERALE SIDE FLANGE	ANGOLARE ANGULAR	FLANGIA FRONTALE FRONT FLANGE	FLANGIA LATERALE SIDE FLANGE	
400	400		R1ZPRO401	R1ZPRO401		R1ZPRO402	R1ZPRO402	
	500			R1ZPRO501				R1ZPRO502
	600			R1ZPRO601				R1ZPRO602
600	400		R1ZPRO601	R1ZPRO401		R1ZPRO602	R1ZPRO402	
	500			R1ZPRO501				R1ZPRO502
	600			R1ZPRO601				R1ZPRO602
800	400	R1ZCOR1	R1ZPRO801	R1ZPRO401	R1ZCOR2	R1ZPRO802	R1ZPRO402	
	500			R1ZPRO501				R1ZPRO502
	600			R1ZPRO601				R1ZPRO602
1000	400		R1ZPRO1001	R1ZPRO401		R1ZPRO1002	R1ZPRO402	
	500			R1ZPRO501				R1ZPRO502
	600			R1ZPRO601				R1ZPRO602
**1200	400		R1ZPRO1201	R1ZPRO401		R1ZPRO1202	R1ZPRO402	
	500			R1ZPRO501				R1ZPRO502
	600			R1ZPRO601				R1ZPRO602

* Tetto con flangia / Roof with a flange
** Armadio con doppia anta / Doble door cabinet

■ Armadi per quadri elettrici componibili CQE

CQE modular enclosure

Versione in kit Kit version

H 1800



DIMENSIONI ARMADIO ENCLOSURE DIMENSIONS		TETTO E BASE ROOF AND BASE	MONTANTI UPRIGHTS	PANNELLO CABLAGGIO MOUNTING PANEL	PORTA CIECA BLANK DOOR	PORTA CIECA BLANK DOOR	RETRO REAR PANEL	LATERALI SIDE PANELS
LARGHEZZA WIDTH	PROFONDITÀ DEPTH							
300	300	R1KTB33	R5KMN18					R5LE1832
	400	R1KTB34						R5LE1842
	500	R1KTB35		RZPCE1830	R5CPE1830		R5CRE1830	R5LE1852
	600	R1KTB36						R5LE1862
	800	R1KTB38						R5LE1882
400	300	R1KTB43						R5LE1832
	400	R1KTB44						R5LE1842
	500	R1KTB45		RZPCE1840	R5CPE1840		R5CRE1840	R5LE1852
	600	R1KTB46						R5LE1862
	800	R1KTB48						R5LE1882
600	300	R1KTB63						R5LE1832
	400	R1KTB64						R5LE1842
	500	R1KTB65		RZPCE1860	R5CPE1860		R5CRE1860	R5LE1852
	600	R1KTB66						R5LE1862
	800	R1KTB68						R5LE1882
800	300	R1KTB83						R5LE1832
	400	R1KTB84						R5LE1842
	500	R1KTB85		RZPCE1880	R5CPE1880		R5CRE1880	R5LE1852
	600	R1KTB86						R5LE1862
	800	R1KTB88						R5LE1882
1000	400	R1KTB104					R5LE1842	
	500	R1KTB105					R5LE1852	
	600	R1KTB106	RZPCE18100	R5CPE18100		R5CRE18100	R5LE1862	
	800	R1KTB108					R5LE1882	
**1200	400	R1KTB124					R5LE1842	
	500	R1KTB125					R5LE1852	
	600	R1KTB126	RZPCE18120	-	R5CPE18120	R5CRE18120	R5LE1862	
	800	R1KTB128					R5LE1882	

* Tetto con flangia / Roof with a flange
** Armadio con doppia anta / Doble door cabinet

■ Armadi per quadri elettrici componibili CQE

CQE modular enclosure

Versione in kit
Kit version

H 1800



DIMENSIONI ARMADIO ENCLOSURE DIMENSIONS		ZOCOLO H.100 PLINTH H.100		ZOCOLO H.200 PLINTH H.200			
LARGHEZZA WIDTH	PROFONDITÀ DEPTH	ANGOLARE ANGULAR	FLANGIA FRONTALE FRONT FLANGE	FLANGIA LATERALE SIDE FLANGE	ANGOLARE ANGULAR	FLANGIA FRONTALE FRONT FLANGE	FLANGIA LATERALE SIDE FLANGE
300	300	R1ZCOR1	R1ZPRO301	R1ZPRO301	R1ZCOR2	R1ZPRO302	R1ZPRO302
	400			R1ZPRO401			R1ZPRO402
	500			R1ZPRO501			R1ZPRO502
	600			R1ZPRO601			R1ZPRO602
400	800	R1ZPRO401	R1ZPRO401	R1ZPRO401	R1ZPRO402	R1ZPRO402	R1ZPRO402
	300			R1ZPRO301			R1ZPRO302
	400			R1ZPRO401			R1ZPRO402
	500			R1ZPRO501			R1ZPRO502
600	600	R1ZPRO601	R1ZPRO601	R1ZPRO601	R1ZPRO602	R1ZPRO602	R1ZPRO602
	800			R1ZPRO801			R1ZPRO802
	300			R1ZPRO301			R1ZPRO302
	400			R1ZPRO401			R1ZPRO402
800	500	R1ZPRO801	R1ZPRO801	R1ZPRO801	R1ZPRO802	R1ZPRO802	R1ZPRO802
	600			R1ZPRO601			R1ZPRO602
	800			R1ZPRO801			R1ZPRO802
	400			R1ZPRO401			R1ZPRO402
1000	500	R1ZPRO1001	R1ZPRO1001	R1ZPRO501	R1ZPRO1002	R1ZPRO1002	R1ZPRO502
	600			R1ZPRO601			R1ZPRO602
	800			R1ZPRO801			R1ZPRO802
	400			R1ZPRO401			R1ZPRO402
**1200	500	R1ZPRO1201	R1ZPRO1201	R1ZPRO501	R1ZPRO1202	R1ZPRO1202	R1ZPRO502
	600			R1ZPRO601			R1ZPRO602
	800			R1ZPRO801			R1ZPRO802

* Tetto con flangia / Roof with a flange
** Armadio con doppia anta / Doble door cabinet

■ Armadi per quadri elettrici componibili CQE

CQE modular enclosure

Versione in kit
Kit version

H 2000



DIMENSIONI ARMADIO ENCLOSURE DIMENSIONS		TETTO E BASE ROOF AND BASE	MONTANTI UPRIGHTS	PANNELLO CABLAGGIO MOUNTING PANEL	PORTA CIECA BLANK DOOR	PORTA CIECA BLANK DOOR	RETRO REAR PANEL	LATERALI SIDE PANELS		
LARGHEZZA WIDTH	PROFONDITÀ DEPTH									
300	300	R1KTB33	R5KMN20				R5CRE2030	R5LE2032		
	400	R1KTB34						R5LE2042		
	500	R1KTB35						RZPCE2030	R5CPE2030	R5LE2052
	600	R1KTB36						R5LE2062		
	800	R1KTB38						R5LE2082		
400	300	R1KTB43		RZPCE2040	R5CPE2040	R5CRE2040	R5LE2032			
	400	R1KTB44					R5LE2042			
	500	R1KTB45					R5LE2052			
	600	R1KTB46					R5LE2062			
	800	R1KTB48					R5LE2082			
600	300	R1KTB63		RZPCE2060	R5CPE2060	R5CRE2060	R5LE2032			
	400	R1KTB64					R5LE2042			
	500	R1KTB65					R5LE2052			
	600	R1KTB66					R5LE2062			
	800	R1KTB68					R5LE2082			
800	300	R1KTB83		RZPCE2080	R5CPE2080	R5CRE2080	R5LE2032			
	400	R1KTB84					R5LE2042			
	500	R1KTB85					R5LE2052			
	600	R1KTB86					R5LE2062			
	800	R1KTB88					R5LE2082			
1000	400	R1KTB104	RZPCE20100	R5CPE20100	R5CRE20100	R5LE2042				
	500	R1KTB105				R5LE2052				

* Tetto con flangia / Roof with a flange
** Armadio con doppia anta / Doble door cabinet

■ Armadi per quadri elettrici componibili CQE

CQE modular enclosure

Versione in kit
Kit version

H 2000



DIMENSIONI ARMADIO ENCLOSURE DIMENSIONS		ZOCZOLO H.100 PLINTH H.100		ZOCZOLO H.200 PLINTH H.200	
LARGHEZZA WIDTH	PROFONDITÀ DEPTH	ANGOLARE ANGULAR	FLANGIA FRONTALE FRONT FLANGE	ANGOLARE ANGULAR	FLANGIA FRONTALE FRONT FLANGE
			FLANGIA LATERALE SIDE FLANGE		FLANGIA LATERALE SIDE FLANGE
300	300		R1ZPRO301		R1ZPRO302
	400		R1ZPRO401		R1ZPRO402
	500		R1ZPRO501		R1ZPRO502
	600		R1ZPRO601		R1ZPRO602
400	800	R1ZPRO301	R1ZPRO801	R1ZPRO302	R1ZPRO802
	300		R1ZPRO301		R1ZPRO302
	400		R1ZPRO401		R1ZPRO402
	500		R1ZPRO501		R1ZPRO502
600	600	R1ZPRO401	R1ZPRO601	R1ZPRO402	R1ZPRO602
	800		R1ZPRO801		R1ZPRO802
	300		R1ZPRO301		R1ZPRO302
	400		R1ZPRO401		R1ZPRO402
800	500	R1ZPRO601	R1ZPRO501	R1ZPRO602	R1ZPRO502
	600		R1ZPRO601		R1ZPRO602
	800		R1ZPRO801		R1ZPRO802
	300		R1ZPRO301		R1ZPRO302
1000	400	R1ZCOR1	R1ZPRO401	R1ZCOR2	R1ZPRO402
	500		R1ZPRO501		R1ZPRO502
	600		R1ZPRO601		R1ZPRO602
	800		R1ZPRO801		R1ZPRO802
800	300	R1ZPRO801	R1ZPRO301	R1ZPRO802	R1ZPRO302
	400		R1ZPRO401		R1ZPRO402
	500		R1ZPRO501		R1ZPRO502
	600		R1ZPRO601		R1ZPRO602
800	800	R1ZPRO801	R1ZPRO801	R1ZPRO802	R1ZPRO802
	400		R1ZPRO401		R1ZPRO402
	500		R1ZPRO501		R1ZPRO502
1000	600	R1ZPRO801	R1ZPRO601	R1ZPRO802	R1ZPRO602
	800		R1ZPRO801		R1ZPRO802
	400		R1ZPRO401		R1ZPRO402
1000	500	R1ZPRO1001	R1ZPRO501	R1ZPRO1002	R1ZPRO502
	400		R1ZPRO401		R1ZPRO402

* Tetto con flangia / Roof with a flange
** Armadio con doppia anta / Doble door cabinet

■ Armadi per quadri elettrici componibili CQE

CQE modular enclosure

Versione in kit
Kit version

H 2000



DIMENSIONI ARMADIO ENCLOSURE DIMENSIONS		TETTO E BASE ROOF AND BASE	MONTANTI UPRIGHTS	PANNELLO CABLAGGIO MOUNTING PANEL	PORTA CIECA BLANK DOOR	PORTA CIECA BLANK DOOR	RETRO REAR PANEL	LATERALI SIDE PANELS	
LARGHEZZA WIDTH	PROFONDITÀ DEPTH								
1000	600	R1KTB106	R5KMN20	RZPCE20100	R5CPE20100	-	R5CRE20100	R5LE2062	
	800	R1KTB108						R5LE2082	
	400	R1KTB124						R5LE2042	
**1200	500	R1KTB125			RZPCE20120		R5CPE20120	R5CRE20120	R5LE2052
	600	R1KTB126							R5LE2062
	800	R1KTB128							R5LE2082
**1400	400	R1KTB144							R5LE2042
	500	R1KTB145							R5LE2052
	600	R1KTB146			RZPCE20140	-	R5CPE20140	R5CRE20140	R5LE2062
	800	R1KTB148							R5LE2082
**1600	400	R1KTB164							R5LE2042
	500	R1KTB165							R5LE2052
	600	R1KTB166			RZPCE20160		R5CPE20160	R5CRE20160	R5LE2062
	800	R1KTB168							R5LE2082

* Tetto con flangia / Roof with a flange
** Armadio con doppia anta / Doble door cabinet

■ Armadi per quadri elettrici componibili CQE

CQE modular enclosure

Versione in kit
Kit version

H 2000



DIMENSIONI ARMADIO ENCLOSURE DIMENSIONS		ZOCOLO H.100 PLINTH H.100			ZOCOLO H.200 PLINTH H.200				
LARGHEZZA WIDTH	PROFONDITÀ DEPTH	ANGOLARE ANGULAR	FLANGIA FRONTALE FRONT FLANGE	FLANGIA LATERALE SIDE FLANGE	ANGOLARE ANGULAR	FLANGIA FRONTALE FRONT FLANGE	FLANGIA LATERALE SIDE FLANGE		
1000	600	R1ZCOR1	R1ZPRO1001	R1ZPRO601	R1ZCOR2	R1ZPRO1002	R1ZPRO602		
	800			R1ZPRO801			R1ZPRO802		
**1200	400		R1ZPRO1201	R1ZPRO1201		R1ZPRO401	R1ZPRO1202	R1ZPRO1202	R1ZPRO402
	500					R1ZPRO501			R1ZPRO502
	600					R1ZPRO601			R1ZPRO602
	800					R1ZPRO801			R1ZPRO802
**1400	400		R1ZPRO1401	R1ZPRO1401		R1ZPRO401	R1ZPRO1402	R1ZPRO1402	R1ZPRO402
	500					R1ZPRO501			R1ZPRO502
	600					R1ZPRO601			R1ZPRO602
	800					R1ZPRO801			R1ZPRO802
**1600	400		R1ZPRO1601	R1ZPRO1601		R1ZPRO401	R1ZPRO1602	R1ZPRO1602	R1ZPRO402
	500					R1ZPRO501			R1ZPRO502
	600	R1ZPRO601			R1ZPRO602				
	800	R1ZPRO801			R1ZPRO802				

* Tetto con flangia / Roof with a flange
** Armadio con doppia anta / Doble door cabinet

■ Armadi per quadri elettrici componibili CQE

CQE modular enclosure

Versione in kit
Kit version

H 2200



DIMENSIONI ARMADIO ENCLOSURE DIMENSIONS		TETTO E BASE ROOF AND BASE	MONTANTI UPRIGHTS	PANNELLO CABLAGGIO MOUNTING PANEL	PORTA CIECA BLANK DOOR	PORTA CIECA BLANK DOOR	RETRO REAR PANEL	LATERALI SIDE PANELS
LARGHEZZA WIDTH	PROFONDITÀ DEPTH							
300	300	R1KTB33	R5KMN22					R5LE2232
	400	R1KTB34						R5LE2242
	500	R1KTB35		RZPCE2230	R5CPE2230		R5CRE2230	R5LE2252
	600	R1KTB36						R5LE2262
	800	R1KTB38						R5LE2282
400	300	R1KTB43						R5LE2232
	400	R1KTB44						R5LE2242
	500	R1KTB45		RZPCE2240	R5CPE2240		R5CRE2240	R5LE2252
	600	R1KTB46						R5LE2262
	800	R1KTB48						R5LE2282
600	300	R1KTB63						R5LE2232
	400	R1KTB64						R5LE2242
	500	R1KTB65		RZPCE2260	R5CPE2260		R5CRE2260	R5LE2252
	600	R1KTB66						R5LE2262
	800	R1KTB68						R5LE2282
800	300	R1KTB83						R5LE2232
	400	R1KTB84						R5LE2242
	500	R1KTB85		RZPCE2280	R5CPE2280		R5CRE2280	R5LE2252
	600	R1KTB86						R5LE2262
	800	R1KTB88						R5LE2282
1000	400	R1KTB104					R5LE2242	
	500	R1KTB105					R5LE2252	
	600	R1KTB106	RZPCE22100	R5CPE22100		R5CRE22100	R5LE2262	
	800	R1KTB108					R5LE2282	
**1200	400	R1KTB124					R5LE2242	
	500	R1KTB125					R5LE2252	
	600	R1KTB126	RZPCE22120	-	R5CPE22120	R5CRE22120	R5LE2262	
	800	R1KTB128					R5LE2282	

* Tetto con flangia / Roof with a flange
** Armadio con doppia anta / Doble door cabinet

■ Armadi per quadri elettrici componibili CQE

CQE modular enclosure

Versione in kit
Kit version

H 2200



DIMENSIONI ARMADIO ENCLOSURE DIMENSIONS		ZOCOLO H.100 PLINTH H.100			ZOCOLO H.200 PLINTH H.200		
LARGHEZZA WIDTH	PROFONDITÀ DEPTH	ANGOLARE ANGULAR	FLANGIA FRONTALE FRONT FLANGE	FLANGIA LATERALE SIDE FLANGE	ANGOLARE ANGULAR	FLANGIA FRONTALE FRONT FLANGE	FLANGIA LATERALE SIDE FLANGE
300	300	R1ZCOR1	R1ZPRO301	R1ZPRO301	R1ZCOR2	R1ZPRO302	R1ZPRO302
	400			R1ZPRO401			R1ZPRO402
	500			R1ZPRO501			R1ZPRO502
	600			R1ZPRO601			R1ZPRO602
400	800	R1ZPRO401	R1ZPRO401	R1ZPRO401	R1ZPRO402	R1ZPRO402	R1ZPRO402
	300			R1ZPRO301			R1ZPRO302
	400			R1ZPRO401			R1ZPRO402
	500			R1ZPRO501			R1ZPRO502
600	600	R1ZPRO601	R1ZPRO601	R1ZPRO601	R1ZPRO602	R1ZPRO602	R1ZPRO602
	800			R1ZPRO801			R1ZPRO802
	300			R1ZPRO301			R1ZPRO302
	400			R1ZPRO401			R1ZPRO402
800	500	R1ZPRO801	R1ZPRO801	R1ZPRO801	R1ZPRO802	R1ZPRO802	R1ZPRO802
	600			R1ZPRO601			R1ZPRO602
	800			R1ZPRO801			R1ZPRO802
	400			R1ZPRO401			R1ZPRO402
1000	500	R1ZPRO1001	R1ZPRO1001	R1ZPRO1001	R1ZPRO1002	R1ZPRO1002	R1ZPRO1002
	600			R1ZPRO601			R1ZPRO602
	800			R1ZPRO801			R1ZPRO802
	400			R1ZPRO401			R1ZPRO402
**1200	500	R1ZPRO1201	R1ZPRO1201	R1ZPRO1201	R1ZPRO1202	R1ZPRO1202	R1ZPRO1202
	600			R1ZPRO601			R1ZPRO602
	800			R1ZPRO801			R1ZPRO802

* Tetto con flangia / Roof with a flange
** Armadio con doppia anta / Doble door cabinet

■ Armadi per quadri elettrici componibili CQE

CQE modular enclosure

Tetto e base per armadio

Roof and base for cabinet



- Realizzato in lamiera d'acciaio sp. 15/10 verniciato RAL 7011 bucciato.
- **Completo di fondo con ingresso cavi regolabile.**
- Fornito con giunti ortogonali che consentono un rapido montaggio della struttura con sole 16 viti.
- Possibilità di personalizzazione fondo con le varie soluzioni per la gestione dei cavi.

- Made in 15/10 thick steel sheet RAL 7011 textured painted.
- **Complete with adjustable bottom gland plate.**
- Supplied with orthogonal joints that allow a quick assembly of the structure with only 16 screws.
- Customizable bottom for various cable management solutions.

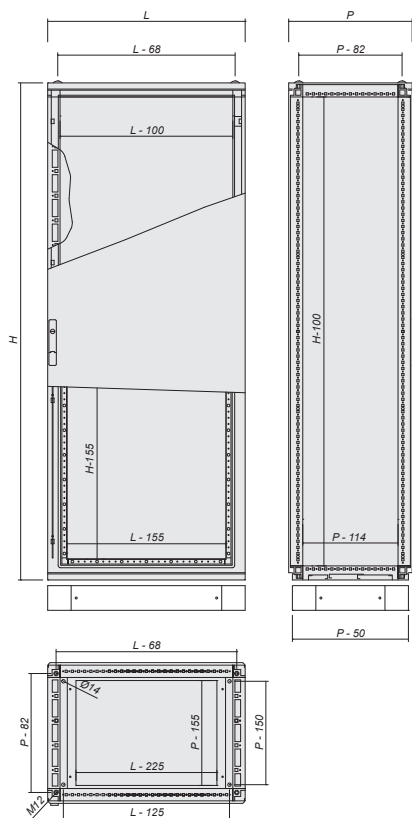

CODICE CODE	DIMENSIONI, MM DIMENSIONS, MM	
	LARGHEZZA (mm) WIDTH (mm)	PROFONDITÀ (mm) DEPTH (mm)
R1KTB33		300
R1KTB34		400
R1KTB35	300	500
R1KTB36		600
R1KTB38		800
R1KTB43		300
R1KTB44		400
R1KTB45	400	500
R1KTB46		600
R1KTB48		800
R1KTB63		300
R1KTB64		400
R1KTB65	600	500
R1KTB66		600
R1KTB68		800
R1KTB83		300
R1KTB84		400
R1KTB85	800	500
R1KTB86		600
R1KTB88		800
R1KTB104		400
R1KTB105	1000	500
R1KTB106		600
R1KTB108		800
R1KTB124		400
R1KTB125	1200	500
R1KTB126		600
R1KTB128		800
R1KTB144		400
R1KTB145	1400	500
R1KTB146		600
R1KTB148		800
R1KTB164		400
R1KTB165	1600	500
R1KTB166		600
R1KTB168		800

■ Armadi per quadri elettrici componibili CQE

CQE modular enclosure

Montanti per armadio

Uprights for cabinet



- Realizzati in lamiera d'acciaio sp. 15/10 verniciato RAL 7035 bucciato.
- Profilo piegato 8 volte e saldato, per una robustezza elevata ai massimi livelli di mercato.
- Adatti per ogni configurazione.
- Gli accessori di fissaggio sono forniti insieme a porta, retro e pannelli laterali (da ordinare a completamento).

- Made of 15/10 thick steel sheet RAL 7035 textured painted.
- Patented profile folded 8 times and welded for a robustness elevated to the highest market levels.
- Suitable for any configuration.
- Fastening accessories are provided along with doors, rear and side panels to (be ordered for enclosure completion).

CODICE CODE	DIMENSIONI, MM DIMENSIONS, MM
	ALTEZZA ELEMENTO (mm) ELEMENT HEIGHT (mm)
R5KMN12	1200
R5KMN14	1400
R5KMN16	1600
R5KMN18	1800
R5KMN20	2000
R5KMN22	2200

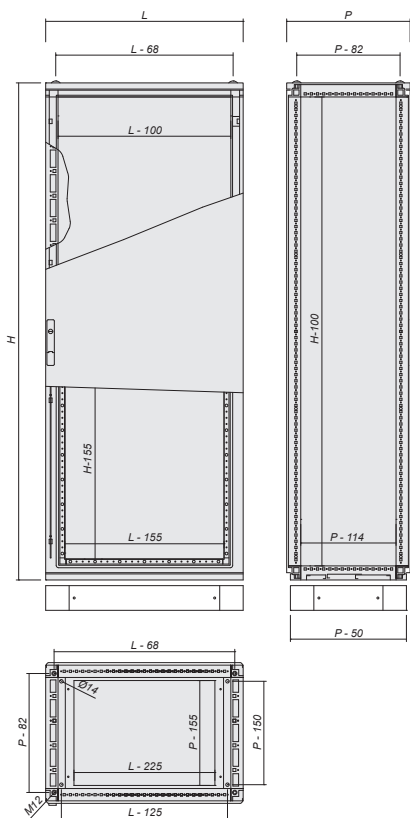

■ Armadi per quadri elettrici componibili CQE

CQE modular enclosure

Armadio solo struttura

Modular Cabinet Structure only



IP55

Telaio

struttura assemblata con profilo chiuso in acciaio zincato sp. 15/10 verniciato RAL 7035 bucciato.

Tetto e base

lamiera d'acciaio sp. 15/10 verniciati RAL 7011 bucciato, asportabili.

Fondo

lamiera d'acciaio zincato sp. 15/10 con ingresso cavi regolabile.

Composizione

telaio, tetto, base e fondo.

Grado di protezione

TYPE 4 con porta anta singola cieca.

Il grado di protezione IP/TYPE si riferisce all'armadio/batteria di armadi completi di porte, retri e laterali.

Structure

Assembled structure with a closed profile in 15/10 thick galvanized steel painted with RAL 7035, textured finish.

Roof and base

Made of 15/10 thick steel, painted with RAL 7011, textured finish. Removable.

Bottom

15/10 thick galvanized steel, adjustable cable gland.

Composition

Structure, roof, base and bottom.

Degree of protection

TYPE 4 with single blind door.

The IP/TYPE degree of protection refers to the cabinet/battery of cabinets complete with doors, rear and side panels.

H 1200

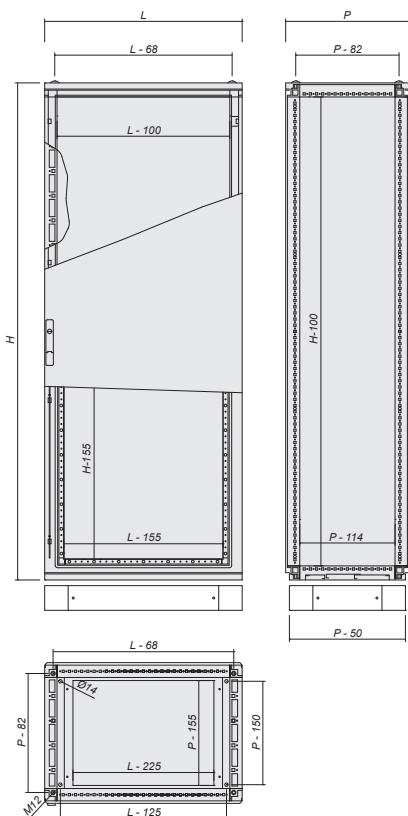

CODICE CODE	LARGHEZZA (mm) WIDTH (mm)	DIMENSIONI, MM DIMENSIONS, MM	
		PROFONDITÀ (mm) DEPTH (mm)	
R5CQE1244S			400
R5CQE1245S	400		500
R5CQE1246S			600
R5CQE1264S			400
R5CQE1265S	600		500
R5CQE1266S			600
R5CQE1284S			400
R5CQE1285S	800		500
R5CQE1286S			600
R5CQE12104S			400
R5CQE12105S	1000		500
R5CQE12106S			600
R5CQE12124S			400
R5CQE12125S	1200		500
R5CQE12126S			600

H 1400

CODICE CODE	LARGHEZZA (mm) WIDTH (mm)	DIMENSIONI, MM DIMENSIONS, MM	
		PROFONDITÀ (mm) DEPTH (mm)	
R5CQE1464S			400
R5CQE1465S	600		500
R5CQE1484S			400
R5CQE1485S	800		500
R5CQE14124S			400
R5CQE14125S	1200		500
R5CQE14164S	1600		400

■ Armadi per quadri elettrici componibili CQE

CQE modular enclosure

Armadio solo struttura

Modular Cabinet Structure only



H 1400

CODICE CODE	LARGHEZZA (mm) WIDTH (mm)	DIMENSIONI, MM	PROFONDITÀ (mm) DEPTH (mm)
		DIMENSIONS, MM	
R5CQE14165S	1600		500

H 1600

CODICE CODE	LARGHEZZA (mm) WIDTH (mm)	DIMENSIONI, MM	PROFONDITÀ (mm) DEPTH (mm)
		DIMENSIONS, MM	
R5CQE1644S			400
R5CQE1645S	400		500
R5CQE1646S			600
R5CQE1664S			400
R5CQE1665S	600		500
R5CQE1666S			600
R5CQE1684S			400
R5CQE1685S	800		500
R5CQE1686S			600
R5CQE16104S			400
R5CQE16105S	1000		500
R5CQE16106S			600
R5CQE16124S			400
R5CQE16125S	1200		500
R5CQE16126S			600

H 1800

CODICE CODE	LARGHEZZA (mm) WIDTH (mm)	DIMENSIONI, MM	PROFONDITÀ (mm) DEPTH (mm)
		DIMENSIONS, MM	
R5CQE1833S			300
R5CQE1834S			400
R5CQE1835S			500
R5CQE1836S	300		600
R5CQE1838S			800
R5CQE18310S			1000
R5CQE1843S			300
R5CQE1844S			400
R5CQE1845S			500
R5CQE1846S	400		600
R5CQE1848S			800
R5CQE18410S			1000
R5CQE1863S			300
R5CQE1864S			400
R5CQE1865S			500
R5CQE1866S	600		600
R5CQE1868S			800
R5CQE18610S			1000
R5CQE1883S			300
R5CQE1884S			400
R5CQE1885S			500
R5CQE1886S	800		600
R5CQE1888S			800
R5CQE18810S			1000
R5CQE18104S	1000		400

■ Armadi per quadri elettrici componibili CQE

CQE modular enclosure

Armadio solo struttura

Modular Cabinet Structure only



H 1800

CODICE CODE	LARGHEZZA (mm) WIDTH (mm)	DIMENSIONI, MM DIMENSIONS, MM
		PROFONDITÀ (mm) DEPTH (mm)
R5CQE18105S		500
R5CQE18106S	1000	600
R5CQE18108S		800
R5CQE181010S		1000
R5CQE18124S		400
R5CQE18125S	1200	500
R5CQE18126S		600
R5CQE18128S		800
R5CQE181210S		1000

H 2000

CODICE CODE	LARGHEZZA (mm) WIDTH (mm)	DIMENSIONI, MM DIMENSIONS, MM	
		PROFONDITÀ (mm) DEPTH (mm)	
R5CQE2033S		300	
R5CQE2034S		400	
R5CQE2035S	300	500	
R5CQE2036S		600	
R5CQE2038S		800	
R5CQE20310S		1000	
R5CQE2043S		400	300
R5CQE2044S			400
R5CQE2045S	500		
R5CQE2046S	600		
R5CQE2048S	800		
R5CQE20410S	1000		
R5CQE2063S	600	300	
R5CQE2064S		400	
R5CQE2065S		500	
R5CQE2066S		600	
R5CQE2068S		800	
R5CQE20610S		1000	
R5CQE2083S	800	300	
R5CQE2084S		400	
R5CQE2085S		500	
R5CQE2086S		600	
R5CQE2088S		800	
R5CQE20810S		1000	
R5CQE20104S	1000	400	
R5CQE20105S		500	
R5CQE20106S		600	
R5CQE20108S		800	
R5CQE201010S		1000	
R5CQE20124S		1200	400
R5CQE20125S	500		
R5CQE20126S	600		
R5CQE20128S	800		
R5CQE201210S	1000		
R5CQE20144S	1400		400
R5CQE20145S		500	

■ Armadi per quadri elettrici componibili CQE

CQE modular enclosure

Armadio solo struttura

Modular Cabinet Structure only



H 2000

CODICE CODE	LARGHEZZA (mm) WIDTH (mm)	DIMENSIONI, MM DIMENSIONS, MM	
		PROFONDITÀ (mm) DEPTH (mm)	
R5CQE20146S	1400	600	
R5CQE20148S		800	
R5CQE201410S		1000	
R5CQE20164S	1600	400	
R5CQE20165S		500	
R5CQE20166S		600	
R5CQE20168S		800	
R5CQE201610S		1000	
R5CQE201610S		1000	

H 2200

CODICE CODE	LARGHEZZA (mm) WIDTH (mm)	DIMENSIONI, MM DIMENSIONS, MM	
		PROFONDITÀ (mm) DEPTH (mm)	
R5CQE2233S	300	300	
R5CQE2234S		400	
R5CQE2235S		500	
R5CQE2236S		600	
R5CQE2238S		800	
R5CQE22310S		1000	
R5CQE2243S		400	300
R5CQE2244S	400		
R5CQE2245S	500		
R5CQE2246S	600		
R5CQE2248S	800		
R5CQE22410S	1000		
R5CQE2263S	600		300
R5CQE2264S		400	
R5CQE2265S		500	
R5CQE2266S		600	
R5CQE2268S		800	
R5CQE22610S		1000	
R5CQE2283S		800	300
R5CQE2284S	400		
R5CQE2285S	500		
R5CQE2286S	600		
R5CQE2288S	800		
R5CQE22810S	1000		
R5CQE22104S	1000		400
R5CQE22105S		500	
R5CQE22106S		600	
R5CQE22108S		800	
R5CQE221010S	1200	1000	
R5CQE22124S		400	
R5CQE22125S		500	
R5CQE22126S		600	
R5CQE22128S		800	
R5CQE221210S	1000		

■ Armadi per quadri elettrici componibili CQE

CQE modular enclosure

Armadio con retro

CQE enclosure structure and rear panel



Telaio

struttura assemblata con profilo chiuso in acciaio zincato sp. 15/10 verniciato RAL 7035 bucciato.

Tetto e base

lamiera d'acciaio sp. 15/10 verniciati RAL 7011 bucciato, asportabili.

Fondo

lamiera d'acciaio zincato sp. 15/10 con ingresso cavi regolabile.

Retro

lamiera d'acciaio sp. 15/10 verniciato RAL 7035 bucciato e 8 punti di fissaggio alla struttura.

Composizione

telaio, tetto, base, fondo e retro.

Grado di protezione

TYPE 4 con porta anta singola cieca.

TYPE 12 con porta doppia anta cieca (da L 1200).

Il grado di protezione IP/TYPE si riferisce all'armadio/batteria di armadi completi di porte, retri e laterali.

Structure

Assembled structure with a closed profile in 15/10 thick galvanized steel painted with RAL 7035, textured finish.

Roof and base

Made of 15/10 thick steel, painted with RAL7011, textured finish. Removable.

Bottom

15/10 thick galvanized steel, adjustable cable gland.

Rear panel

15/10 thick steel sheet, painted with RAL7035, textured finish, and 8 mounting points to the structure.

Composition

Structure, roof, base, bottom and rear panel.

Protection degree

TYPE 4 with single blind door

TYPE 12 with double blind door (from L1200)

The IP/TYPE degree of protection refers to the cabinet/battery of cabinets complete with doors and side panels.

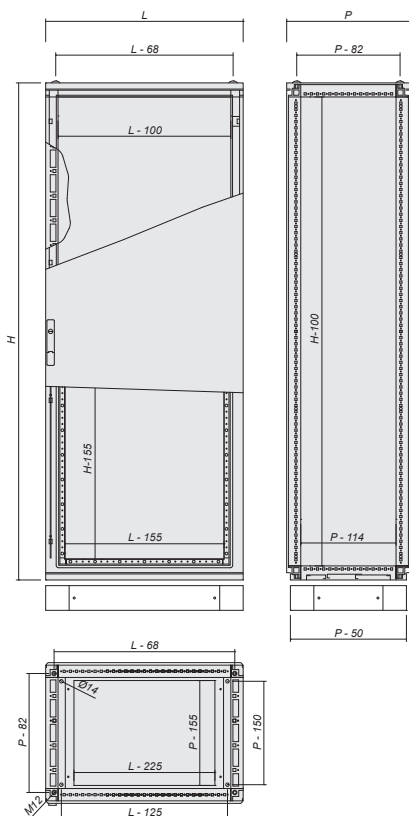

H 1200

CODICE CODE	DIMENSIONI, MM DIMENSIONS, MM	
	LARGHEZZA (mm) WIDTH (mm)	PROFONDITÀ (mm) DEPTH (mm)
R5CQE1244R		400
R5CQE1245R	400	500
R5CQE1246R		600
R5CQE1264R		400
R5CQE1265R	600	500
R5CQE1266R		600
R5CQE1284R		400
R5CQE1285R	800	500
R5CQE1286R		600
R5CQE12104R		400
R5CQE12105R	1000	500
R5CQE12106R		600
R5CQE12124R		400
R5CQE12125R	1200	500
R5CQE12126R		600

■ Armadi per quadri elettrici componibili CQE

CQE modular enclosure

Armadio con retro

CQE enclosure structure and rear panel



H 1400

CODICE CODE	LARGHEZZA (mm) WIDTH (mm)	DIMENSIONI, MM DIMENSIONS, MM	
		PROFONDITÀ (mm) DEPTH (mm)	
R5CQE1464R	600	400	
R5CQE1465R		500	
R5CQE1484R	800	400	
R5CQE1485R		500	
R5CQE14124R	1200	400	
R5CQE14125R		500	
R5CQE14164R	1600	400	
R5CQE14165R		500	

H 1600

CODICE CODE	LARGHEZZA (mm) WIDTH (mm)	DIMENSIONI, MM DIMENSIONS, MM	
		PROFONDITÀ (mm) DEPTH (mm)	
R5CQE1644R	400	400	
R5CQE1645R		500	
R5CQE1646R		600	
R5CQE1664R	600	400	
R5CQE1665R		500	
R5CQE1666R		600	
R5CQE1684R	800	400	
R5CQE1685R		500	
R5CQE1686R		600	
R5CQE16104R	1000	400	
R5CQE16105R		500	
R5CQE16106R		600	
R5CQE16124R	1200	400	
R5CQE16125R		500	
R5CQE16126R		600	

H 1800

CODICE CODE	LARGHEZZA (mm) WIDTH (mm)	DIMENSIONI, MM DIMENSIONS, MM	
		PROFONDITÀ (mm) DEPTH (mm)	
R5CQE1833R	300	300	
R5CQE1834R		400	
R5CQE1835R		500	
R5CQE1836R		600	
R5CQE1838R		800	
R5CQE18310R		1000	
R5CQE1843R		400	300
R5CQE1844R	400		
R5CQE1845R	500		
R5CQE1846R	600		
R5CQE1848R	800		
R5CQE18410R	1000		
R5CQE1863R	600		300
R5CQE1864R		400	
R5CQE1865R		500	
R5CQE1866R		600	
R5CQE1868R		800	
R5CQE18610R		1000	

■ Armadi per quadri elettrici componibili CQE

CQE modular enclosure

Armadio con retro

CQE enclosure structure and rear panel



H 1800

CODICE CODE	LARGHEZZA (mm) WIDTH (mm)	DIMENSIONI, MM DIMENSIONS, MM		
		PROFONDITÀ (mm) DEPTH (mm)		
R5CQE1883R	800	300		
R5CQE1884R		400		
R5CQE1885R		500		
R5CQE1886R		600		
R5CQE1888R		800		
R5CQE18810R		1000		
R5CQE18104R		400		
R5CQE18105R		500		
R5CQE18106R		1000	600	
R5CQE18108R			800	
R5CQE181010R	1000			
R5CQE18124R	400			
R5CQE18125R	1200	500		
R5CQE18126R		600		
R5CQE18128R		800		
R5CQE181210R		1000		

H 2000

CODICE CODE	LARGHEZZA (mm) WIDTH (mm)	DIMENSIONI, MM DIMENSIONS, MM	
		PROFONDITÀ (mm) DEPTH (mm)	
R5CQE2033R	300	300	
R5CQE2034R		400	
R5CQE2035R		500	
R5CQE2036R		600	
R5CQE2038R		800	
R5CQE20310R		1000	
R5CQE2043R		400	300
R5CQE2044R	400		
R5CQE2045R	500		
R5CQE2046R	600		
R5CQE2048R	800		
R5CQE20410R	1000		
R5CQE2063R	600		300
R5CQE2064R		400	
R5CQE2065R		500	
R5CQE2066R		600	
R5CQE2068R		800	
R5CQE20610R		1000	
R5CQE2083R		800	300
R5CQE2084R	400		
R5CQE2085R	500		
R5CQE2086R	600		
R5CQE2088R	800		
R5CQE20810R	1000		
R5CQE20104R	1000		400
R5CQE20105R		500	
R5CQE20106R		600	
R5CQE20108R		800	
R5CQE201010R		1000	

■ Armadi per quadri elettrici componibili CQE

CQE modular enclosure

Armadio con retro

CQE enclosure structure and rear panel



H 2000

CODICE CODE	LARGHEZZA (mm) WIDTH (mm)	DIMENSIONI, MM DIMENSIONS, MM	
		PROFONDITÀ (mm) DEPTH (mm)	
R5CQE20124R	1200	400	
R5CQE20125R		500	
R5CQE20126R		600	
R5CQE20128R		800	
R5CQE201210R		1000	
R5CQE20144R		400	
R5CQE20145R	1400	500	
R5CQE20146R		600	
R5CQE20148R		800	
R5CQE201410R		1000	
R5CQE20164R	1600	400	
R5CQE20165R		500	
R5CQE20166R		600	
R5CQE20168R		800	
R5CQE201610R		1000	

H 2200

CODICE CODE	LARGHEZZA (mm) WIDTH (mm)	DIMENSIONI, MM DIMENSIONS, MM	
		PROFONDITÀ (mm) DEPTH (mm)	
R5CQE2233R	300	300	
R5CQE2234R		400	
R5CQE2235R		500	
R5CQE2236R		600	
R5CQE2238R		800	
R5CQE22310R		1000	
R5CQE2243R	400	300	
R5CQE2244R		400	
R5CQE2245R		500	
R5CQE2246R		600	
R5CQE2248R		800	
R5CQE22410R		1000	
R5CQE2263R	600	300	
R5CQE2264R		400	
R5CQE2265R		500	
R5CQE2266R		600	
R5CQE2268R		800	
R5CQE22610R		1000	
R5CQE2283R	800	300	
R5CQE2284R		400	
R5CQE2285R		500	
R5CQE2286R		600	
R5CQE2288R		800	
R5CQE22810R		1000	
R5CQE22104R	1000	400	
R5CQE22105R		500	
R5CQE22106R		600	
R5CQE22108R		800	
R5CQE221010R		1000	
R5CQE22124R		1200	400

■ Armadi per quadri elettrici componibili CQE CQE modular enclosure

Armadio con retro

CQE enclosure structure and rear panel



H 2200

CODICE CODE	DIMENSIONI, MM DIMENSIONS, MM	
	LARGHEZZA (mm) WIDTH (mm)	PROFONDITÀ (mm) DEPTH (mm)
R5CQE22125R	1200	500
R5CQE22126R		600
R5CQE22128R		800
R5CQE221210R		1000

■ Armadi per quadri elettrici componibili CQE

CQE modular enclosure

Armadio con porta cieca e retro

Modular Cabinets with Blank Door and Rear Panel



IP55

Telaio

Struttura assemblata con profilo chiuso in acciaio zincato sp. 15/10 verniciato RAL7035 bucciato.

Tetto e base

Lamiera d'acciaio sp. 15/10 verniciati RAL7011 bucciato, asportabili.

Fondo

Lamiera d'acciaio zincato sp. 15/10 con ingresso cavi regolabile.

Retro

Lamiera d'acciaio sp. 15/10 verniciato RAL 7035 bucciato e 8 punti di fissaggio alla struttura.

Porta

Lamiera d'acciaio sp. 20/10 verniciata RAL7035 bucciato. Telaio interno di rinforzo in tubolare zincato. 4 punti di chiusura, 4 cerniere e mostrina con inserto di chiusura tipo aletta doppio pettine Ø3 mm.

Grado di resistenza all'urto secondo IEC EN 62208; EN50102: IK10.

Composizione

Telaio, tetto, base, fondo, retro e porta.

Grado di protezione

TYPE 4 con porta anta singola cieca.

Il grado di protezione IP/TYPE si riferisce all'armadio/batteria di armadi completi di porte, retri e laterali.

Structure

Assembled structure with a closed profile in 15/10 thick galvanized steel painted with RAL 7035, textured finish.

Roof and base

Made of 15/10 thick steel, painted with RAL 7011, textured finish. Removable.

Bottom

15/10 thick galvanized steel, adjustable cable gland.

Rear panel

15/10 thick steel sheet, painted with RAL7035, textured finish, and 8 mounting points to the structure.

Door

20/10 thick steel sheet painted with RAL7035, textured finish. Internal reinforcement frame in galvanized tubular with 4 closing points, 4 hinges and an escutcheon with a double-bit lock Ø3 mm insert .

Impact resistance degree as per IEC EN 62208; EN50102: IK10

Composition

Structure, roof, base, bottom, rear panel and door.

Protection degree

TYPE 4 with single blind door

The IP/TYPE degree of protection refers to the cabinet/battery of cabinets complete with side panels.

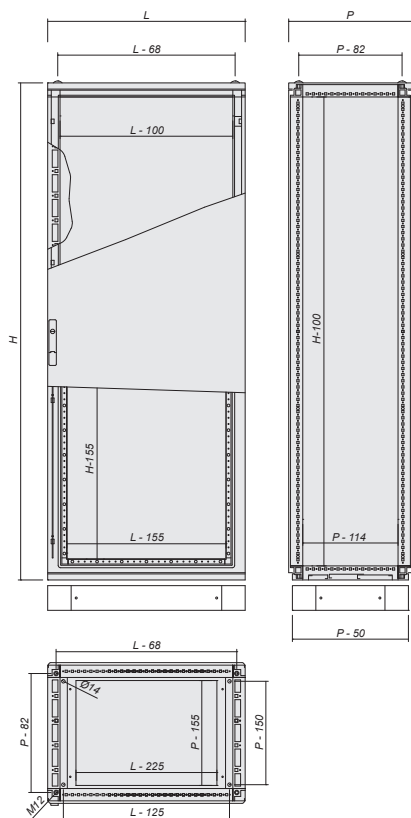

H 1200

CODICE CODE	DIMENSIONI, MM DIMENSIONS, MM	
	LARGHEZZA (mm) WIDTH (mm)	PROFONDITÀ (mm) DEPTH (mm)
R5CQE1244		400
R5CQE1245	400	500
R5CQE1246		600
R5CQE1264		400
R5CQE1265	600	500
R5CQE1266		600
R5CQE1284		400
R5CQE1285	800	500
R5CQE1286		600
R5CQE12104		400
R5CQE12105	1000	500
R5CQE12106		600

■ Armadi per quadri elettrici componibili CQE CQE modular enclosure

Armadio con porta cieca e retro

Modular Cabinets with Blank Door and Rear Panel



H 1400

CODICE CODE	LARGHEZZA (mm) WIDTH (mm)	DIMENSIONI, MM DIMENSIONS, MM	
		PROFONDITÀ (mm) DEPTH (mm)	
R5CQE1464	600	400	
R5CQE1465		500	
R5CQE1484	800	400	
R5CQE1485		500	
R5CQE14124	1200	400	
R5CQE14125		500	
R5CQE14164	1600	400	
R5CQE14165		500	

H 1600

CODICE CODE	LARGHEZZA (mm) WIDTH (mm)	DIMENSIONI, MM DIMENSIONS, MM	
		PROFONDITÀ (mm) DEPTH (mm)	
R5CQE1644	400	400	
R5CQE1645		500	
R5CQE1646		600	
R5CQE1664	600	400	
R5CQE1665		500	
R5CQE1666		600	
R5CQE1684	800	400	
R5CQE1685		500	
R5CQE1686		600	
R5CQE16104	1000	400	
R5CQE16105		500	
R5CQE16106		600	
R5CQE16124	1200	400	
R5CQE16125		500	
R5CQE16126		600	

H 1800

CODICE CODE	LARGHEZZA (mm) WIDTH (mm)	DIMENSIONI, MM DIMENSIONS, MM	
		PROFONDITÀ (mm) DEPTH (mm)	
R5CQE1833	300	300	
R5CQE1834		400	
R5CQE1835		500	
R5CQE1836		600	
R5CQE1838		800	
R5CQE18310		1000	
R5CQE1843		400	300
R5CQE1844	400		
R5CQE1845	500		
R5CQE1846	600		
R5CQE1848	800		
R5CQE18410	1000		
R5CQE1863	600		300
R5CQE1864		400	
R5CQE1865		500	
R5CQE1866		600	
R5CQE1868		800	
R5CQE18610		1000	

■ Armadi per quadri elettrici componibili CQE CQE modular enclosure

Armadio con porta cieca e retro

Modular Cabinets with Blank Door and Rear Panel



H 1800

CODICE CODE	LARGHEZZA (mm) WIDTH (mm)	DIMENSIONI, MM DIMENSIONS, MM	
		PROFONDITÀ (mm) DEPTH (mm)	
R5CQE1883	800	300	
R5CQE1884		400	
R5CQE1885		500	
R5CQE1886		600	
R5CQE1888		800	
R5CQE18810		1000	
R5CQE18104	1000	400	
R5CQE18105		500	
R5CQE18106		600	
R5CQE18108		800	
R5CQE181010		1000	
R5CQE18124		1200	400
R5CQE18125	500		
R5CQE18126	600		
R5CQE18128	800		
R5CQE181210	1000		

H 2000

CODICE CODE	LARGHEZZA (mm) WIDTH (mm)	DIMENSIONI, MM DIMENSIONS, MM	
		PROFONDITÀ (mm) DEPTH (mm)	
R5CQE2033	300	300	
R5CQE2034		400	
R5CQE2035		500	
R5CQE2036		600	
R5CQE2038		800	
R5CQE20310		1000	
R5CQE2043	400	300	
R5CQE2044		400	
R5CQE2045		500	
R5CQE2046		600	
R5CQE2048		800	
R5CQE20410		1000	
R5CQE2063	600	300	
R5CQE2064		400	
R5CQE2065		500	
R5CQE2066		600	
R5CQE2068		800	
R5CQE20610		1000	
R5CQE2083	800	300	
R5CQE2084		400	
R5CQE2085		500	
R5CQE2086		600	
R5CQE2088		800	
R5CQE20810		1000	
R5CQE20104	1000	400	
R5CQE20105		500	
R5CQE20106		600	
R5CQE20108		800	
R5CQE201010		1000	

■ Armadi per quadri elettrici componibili CQE CQE modular enclosure

Armadio con porta cieca e retro

Modular Cabinets with Blank Door and Rear Panel



H 2000

CODICE CODE	LARGHEZZA (mm) WIDTH (mm)	DIMENSIONI, MM DIMENSIONS, MM	
		PROFONDITÀ (mm) DEPTH (mm)	
R5CQE20124	1200	400	
R5CQE20125		500	
R5CQE20126		600	
R5CQE20128		800	
R5CQE201210		1000	
R5CQE20144		1400	400
R5CQE20145	500		
R5CQE20146	600		
R5CQE20148	800		
R5CQE201410	1600	1000	
R5CQE20164		400	
R5CQE20165		500	
R5CQE20166		600	
R5CQE20168		800	
R5CQE201610		1000	

H 2200

CODICE CODE	LARGHEZZA (mm) WIDTH (mm)	DIMENSIONI, MM DIMENSIONS, MM	
		PROFONDITÀ (mm) DEPTH (mm)	
R5CQE2233	300	300	
R5CQE2234		400	
R5CQE2235		500	
R5CQE2236		600	
R5CQE2238		800	
R5CQE22310		1000	
R5CQE2243	400	300	
R5CQE2244		400	
R5CQE2245		500	
R5CQE2246		600	
R5CQE2248		800	
R5CQE22410		1000	
R5CQE2263	600	300	
R5CQE2264		400	
R5CQE2265		500	
R5CQE2266		600	
R5CQE2268		800	
R5CQE22610		1000	
R5CQE2283	800	300	
R5CQE2284		400	
R5CQE2285		500	
R5CQE2286		600	
R5CQE2288		800	
R5CQE22810		1000	
R5CQE22104	1000	400	
R5CQE22105		500	
R5CQE22106		600	
R5CQE22108		800	
R5CQE221010		1000	

■ Armadi per quadri elettrici componibili CQE

CQE modular enclosure

Armadio con porta cieca doppia anta e retro

Modular Cabinets with Double Blank Door and rear panel



IP55

Telaio

Struttura assemblata con profilo chiuso in acciaio zincato sp. 15/10 verniciato RAL7035 bucciato.

Tetto e base

Lamiera d'acciaio sp. 15/10 verniciati RAL 7011 bucciato, asportabili.

Fondo

Lamiera d'acciaio zincato sp. 15/10 con ingresso cavi regolabile.

Retro

Lamiera d'acciaio sp. 15/10 verniciato RAL 7035 bucciato e 8 punti di fissaggio alla struttura.

Porta

Lamiera d'acciaio sp. 20/10 verniciata RAL 7035 bucciato. Telaio interno di rinforzo in tubolare zincato. 4 punti di chiusura, 4 cerniere e mostrina con inserto di chiusura tipo aletta doppio pettine Ø3 mm.

Grado di resistenza all'urto secondo IEC EN 62208; EN50102: IK10.

Composizione

Telaio, tetto, base, fondo, retro e porta.

Grado di protezione

TYPE 12 con porta doppia anta cieca (da L 1200).

Il grado di protezione IP/TYPE si riferisce all'armadio/batteria di armadi completi di porte, retri e laterali.

Structure

Assembled structure with a closed profile in 15/10 thick galvanized steel painted with RAL 7035, textured finish.

Roof and base

Made of 15/10 thick steel, painted with RAL 7011, textured finish. Removable.

Bottom

15/10 thick galvanized steel, adjustable cable gland.

Rear panel

15/10 thick steel sheet, painted with RAL 7035, textured finish, and 8 mounting points to the structure.

Door

20/10 thick steel sheet painted with RAL 7035, textured finish. Internal reinforcement frame in galvanized tubular with 4 closing points, 4 hinges and an escutcheon with a double-bit lock Ø3 mm insert.

Impact resistance degree as per IEC EN62208; EN50102: IK10.

Composition

Structure, roof, base, bottom, rear panel and door.

Protection degree

TYPE 12 with double blind door (from L 1200)

The IP/TYPE degree of protection refers to the cabinet/battery of cabinets complete with side panels.

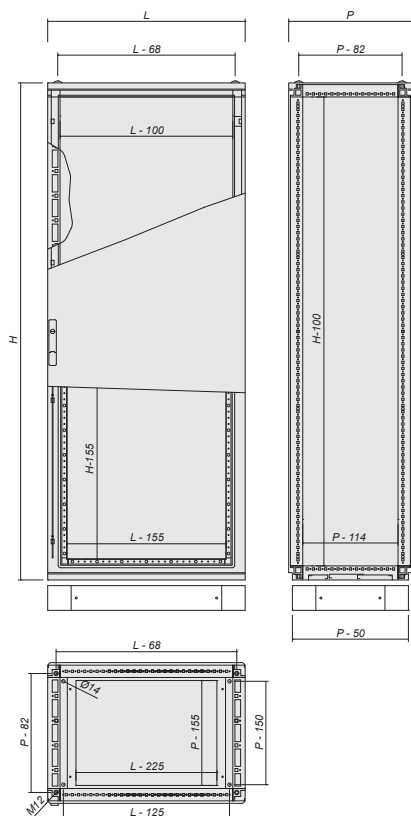

H 1200

CODICE CODE	DIMENSIONI, MM DIMENSIONS, MM	
	LARGHEZZA (mm) WIDTH (mm)	PROFONDITÀ (mm) DEPTH (mm)
R5CQE12841		400
R5CQE12851	800	500
R5CQE12861		600
R5CQE121041		400
R5CQE121051	1000	500
R5CQE121061		600
R5CQE12124		400
R5CQE12125	1200	500
R5CQE12126		600

■ Armadi per quadri elettrici componibili CQE CQE modular enclosure

Armadio con porta cieca doppia anta e retro

Modular Cabinets with Double Blank Door and rear panel



H 1400

CODICE CODE	LARGHEZZA (mm) WIDTH (mm)	DIMENSIONI, MM
		DIMENSIONS, MM
		PROFONDITÀ (mm) DEPTH (mm)
R5CQE14841	800	400
R5CQE14851		500
R5CQE14124	1200	400
R5CQE14125		500
R5CQE14164	1600	400
R5CQE14165		500

H 1600

CODICE CODE	LARGHEZZA (mm) WIDTH (mm)	DIMENSIONI, MM
		DIMENSIONS, MM
		PROFONDITÀ (mm) DEPTH (mm)
R5CQE16841	800	400
R5CQE16851		500
R5CQE16861		600
R5CQE161041	1000	400
R5CQE161051		500
R5CQE161061		600
R5CQE16124	1200	400
R5CQE16125		500
R5CQE16126		600

H 1800

CODICE CODE	LARGHEZZA (mm) WIDTH (mm)	DIMENSIONI, MM
		DIMENSIONS, MM
		PROFONDITÀ (mm) DEPTH (mm)
R5CQE18831	800	300
R5CQE18841		400
R5CQE18851		500
R5CQE18861		600
R5CQE18881		800
R5CQE188101		1000
R5CQE181041	1000	400
R5CQE181051		500
R5CQE181061		600
R5CQE181081		800
R5CQE1810101		1000
R5CQE18124		1200
R5CQE18125	500	
R5CQE18126	600	
R5CQE18128	800	
R5CQE181210	1000	

H 2000

CODICE CODE	LARGHEZZA (mm) WIDTH (mm)	DIMENSIONI, MM
		DIMENSIONS, MM
		PROFONDITÀ (mm) DEPTH (mm)
R5CQE20831	800	300
R5CQE20841		400
R5CQE20851		500
R5CQE20861		600
R5CQE20881		800
R5CQE208101		1000

■ Armadi per quadri elettrici componibili CQE

CQE modular enclosure

Armadio con porta cieca doppia anta e retro

Modular Cabinets with Double Blank Door and rear panel



H 2000

CODICE CODE	LARGHEZZA (mm) WIDTH (mm)	DIMENSIONI, MM DIMENSIONS, MM	PROFONDITÀ (mm) DEPTH (mm)
R5CQE201041			400
R5CQE201051			500
R5CQE201061	1000		600
R5CQE201081			800
R5CQE2010101			1000
R5CQE20124			400
R5CQE20125			500
R5CQE20126	1200		600
R5CQE20128			800
R5CQE201210			1000
R5CQE20144			400
R5CQE20145			500
R5CQE20146	1400		600
R5CQE20148			800
R5CQE201410			1000
R5CQE20164			400
R5CQE20165			500
R5CQE20166	1600		600
R5CQE20168			800
R5CQE201610			1000

H 2200

CODICE CODE	LARGHEZZA (mm) WIDTH (mm)	DIMENSIONI, MM DIMENSIONS, MM	PROFONDITÀ (mm) DEPTH (mm)
R5CQE22831			300
R5CQE22841			400
R5CQE22851	800		500
R5CQE22861			600
R5CQE22881			800
R5CQE228101			1000
R5CQE221041			400
R5CQE221051			500
R5CQE221061	1000		600
R5CQE221081			800
R5CQE2210101			1000
R5CQE22124			400
R5CQE22125			500
R5CQE22126	1200		600
R5CQE22128			800
R5CQE221210			1000

■ Armadi per quadri elettrici componibili CQE

CQE modular enclosure

Armadio con porta cieca, retro e pannello di cablaggio

Modular Cabinets with Blank Door, rear panel and front mounting plate



H 1400

CODICE CODE	LARGHEZZA (mm) WIDTH (mm)	DIMENSIONI, MM DIMENSIONS, MM
		PROFONDITÀ (mm) DEPTH (mm)
R5CQE1464T	600	400
R5CQE1465T		500
R5CQE1484T	800	400
R5CQE1485T		500
R5CQE14124T	1200	400
R5CQE14125T		500
R5CQE14164T	1600	400
R5CQE14165T		500

H 1600

CODICE CODE	LARGHEZZA (mm) WIDTH (mm)	DIMENSIONI, MM DIMENSIONS, MM
		PROFONDITÀ (mm) DEPTH (mm)
R5CQE1644T	400	400
R5CQE1645T		500
R5CQE1646T		600
R5CQE1664T	600	400
R5CQE1665T		500
R5CQE1666T		600
R5CQE1684T	800	400
R5CQE1685T		500
R5CQE1686T		600
R5CQE16104T	1000	400
R5CQE16105T		500
R5CQE16106T		600
R5CQE16124T	1200	400
R5CQE16125T		500
R5CQE16126T		600

H 1800

CODICE CODE	LARGHEZZA (mm) WIDTH (mm)	DIMENSIONI, MM DIMENSIONS, MM
		PROFONDITÀ (mm) DEPTH (mm)
R5CQE1844T	400	400
R5CQE1845T		500
R5CQE1846T		600
R5CQE1848T		800
R5CQE1864T	600	400
R5CQE1865T		500
R5CQE1866T		600
R5CQE1868T		800
R5CQE1884T	800	400
R5CQE1885T		500

■ Armadi per quadri elettrici componibili CQE

CQE modular enclosure

Armadio con porta cieca, retro e pannello di cablaggio

Modular Cabinets with Blank Door, rear panel and front mounting plate



H 1800

CODICE CODE	LARGHEZZA (mm) WIDTH (mm)	DIMENSIONI, MM DIMENSIONS, MM
		PROFONDITÀ (mm) DEPTH (mm)
R5CQE1886T	800	600
R5CQE1888T		800
R5CQE18104T		400
R5CQE18105T	1000	500
R5CQE18106T		600
R5CQE18108T		800
R5CQE18124T	1200	400
R5CQE18125T		500
R5CQE18126T		600
R5CQE18128T		800

H 2000

CODICE CODE	LARGHEZZA (mm) WIDTH (mm)	DIMENSIONI, MM DIMENSIONS, MM
		PROFONDITÀ (mm) DEPTH (mm)
R5CQE2044T	400	400
R5CQE2045T		500
R5CQE2046T		600
R5CQE2048T		800
R5CQE2064T	600	400
R5CQE2065T		500
R5CQE2066T		600
R5CQE2068T		800
R5CQE2084T	800	400
R5CQE2085T		500
R5CQE2086T		600
R5CQE2088T		800
R5CQE20104T	1000	400
R5CQE20105T		500
R5CQE201061T		600
R5CQE20106T		800
R5CQE20124T	1200	400
R5CQE20125T		500
R5CQE20126T		600
R5CQE20128T		800
R5CQE20144T	1400	400
R5CQE20145T		500
R5CQE20146T		600
R5CQE20148T		800
R5CQE20164T	1600	400
R5CQE20165T		500
R5CQE20166T		600
R5CQE20168T		800

■ Armadi per quadri elettrici componibili CQE

CQE modular enclosure

Armadio con porta cieca, retro e pannello di cablaggio

Modular Cabinets with Blank Door, rear panel and front mounting plate



H 2200

CODICE CODE	DIMENSIONI, MM DIMENSIONS, MM	
	LARGHEZZA (mm) WIDTH (mm)	PROFONDITÀ (mm) DEPTH (mm)
R5CQE2245T		500
R5CQE2246T	400	600
R5CQE2248T		800
R5CQE2265T		500
R5CQE2266T	600	600
R5CQE2268T		800
R5CQE2284T		400
R5CQE2285T		500
R5CQE2286T	800	600
R5CQE2288T		800
R5CQE22104T		400
R5CQE22105T		500
R5CQE22106T	1000	600
R5CQE22108T		800
R5CQE22125T		500
R5CQE22126T	1200	600
R5CQE22128T		800

■ Armadi per quadri elettrici componibili CQE

CQE modular enclosure

Armadio con porta trasparente e retro

Modular Cabinets with Glass Door and Rear Panel



IP55

Telaio

struttura assemblata con profilo chiuso in acciaio zincato sp. 15/10 verniciato RAL 7035 bucciato.

Tetto e base

lamiera d'acciaio sp. 15/10 verniciati RAL 7011 bucciato, asportabili.

Fondo

lamiera d'acciaio zincato sp. 15/10 con ingresso cavi regolabile.

Retro

lamiera d'acciaio sp. 15/10 verniciato RAL 7035 bucciato e 8 punti di fissaggio alla struttura.

Porta

lamiera d'acciaio sp. 20/10 verniciata RAL 7035 bucciato. 4 punti di chiusura, 4 cerniere e mostrina con inserto di chiusura tipo aletta doppio pettine Ø3 mm. Vetro di sicurezza sp. 40/10.

Grado di resistenza all'urto secondo IEC EN 62208; EN50102: IK09.

Composizione

telaio, tetto, base, fondo, retro e porta trasparente.

Larghezza 1200 con doppia anta.

Structure

Assembled structure with a closed profile in 15/10 thick galvanized steel painted with RAL 7035, textured finish.

Roof and base

Made of 15/10 thick steel, painted with RAL 7011, textured finish. Removable.

Bottom

15/10 thick galvanized steel, adjustable cable gland.

Rear panel

15/10 thick steel sheet, painted with RAL 7035, textured finish, and 8 mounting points to the structure.

Door

20/10 thick steel sheet painted with RAL 7035, textured finish, with 4 closing points, 4 hinges and an escutcheon with a double-bit lock Ø3 mm insert. Safety glass, thickness 40/10.

Impact resistance degree as per IEC EN 62208; EN50102: IK09.

Composition

Structure, roof, base, bottom, rear panel and glass door.

1200 width with double door.

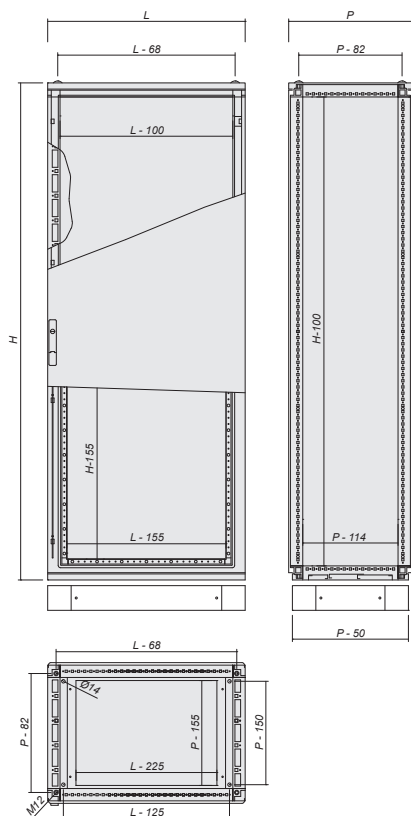

H 1200

CODICE CODE	LARGHEZZA (mm) WIDTH (mm)	DIMENSIONI, MM DIMENSIONS, MM	
		PROFONDITÀ (mm) DEPTH (mm)	
R5CQE1264X	600	400	
R5CQE1265X		500	
R5CQE1266X		600	
R5CQE1284X	800	400	
R5CQE1285X		500	

H 1400

CODICE CODE	LARGHEZZA (mm) WIDTH (mm)	DIMENSIONI, MM DIMENSIONS, MM	
		PROFONDITÀ (mm) DEPTH (mm)	
R5CQE1464X	600	400	
R5CQE1465X		500	
R5CQE1484X		400	
R5CQE1485X	800	500	

■ Armadi per quadri elettrici componibili CQE CQE modular enclosure

Armadio con porta trasparente e retro
Modular Cabinets with Glass Door and Rear Panel



H 1600

CODICE CODE	LARGHEZZA (mm) WIDTH (mm)	DIMENSIONI, MM DIMENSIONS, MM
		PROFONDITÀ (mm) DEPTH (mm)
R5CQE1664X		400
R5CQE1665X	600	500
R5CQE1666X		600
R5CQE1684X		400
R5CQE1685X	800	500
R5CQE1686X		600
R5CQE16104X		400
R5CQE16105X	1000	500
R5CQE16106X		600

H 1800

CODICE CODE	LARGHEZZA (mm) WIDTH (mm)	DIMENSIONI, MM DIMENSIONS, MM
		PROFONDITÀ (mm) DEPTH (mm)
R5CQE1863X		300
R5CQE1864X		400
R5CQE1865X		500
R5CQE1866X	600	600
R5CQE1868X		800
R5CQE18610X		1000
R5CQE1883X		300
R5CQE1884X		400
R5CQE1885X		500
R5CQE1886X	800	600
R5CQE1888X		800
R5CQE18810X		1000
R5CQE18104X		400
R5CQE18105X		500
R5CQE18106X	1000	600
R5CQE18108X		800
R5CQE181010X		1000
R5CQE18124X		400
R5CQE18125X		500
R5CQE18126X	1200	600
R5CQE18128X		800
R5CQE181210X		1000

H 2000

CODICE CODE	LARGHEZZA (mm) WIDTH (mm)	DIMENSIONI, MM DIMENSIONS, MM
		PROFONDITÀ (mm) DEPTH (mm)
R5CQE2063X		300
R5CQE2064X		400
R5CQE2065X		500
R5CQE2066X	600	600
R5CQE2068X		800
R5CQE20610X		1000
R5CQE2083X		300
R5CQE2084X		400
R5CQE2085X	800	500
R5CQE2086X		600

■ Armadi per quadri elettrici componibili CQE CQE modular enclosure

Armadio con porta trasparente e retro

Modular Cabinets with Glass Door and Rear Panel



H 2000

CODICE CODE	DIMENSIONI, MM DIMENSIONS, MM	
	LARGHEZZA (mm) WIDTH (mm)	PROFONDITÀ (mm) DEPTH (mm)
R5CQE2088X	800	800
R5CQE20810X		1000
R5CQE20104X	1000	400
R5CQE20105X		500
R5CQE20106X		600
R5CQE20108X		800
R5CQE201010X	1200	1000
R5CQE20124X		400
R5CQE20125X		500
R5CQE20126X		600
R5CQE20128X		800
R5CQE201210X		1000

H 2200

CODICE CODE	DIMENSIONI, MM DIMENSIONS, MM		
	LARGHEZZA (mm) WIDTH (mm)	PROFONDITÀ (mm) DEPTH (mm)	
R5CQE2263X	600	300	
R5CQE2264X		400	
R5CQE2265X		500	
R5CQE2266X		600	
R5CQE2268X		800	
R5CQE22610X		1000	
R5CQE2283X	800	300	
R5CQE2284X		400	
R5CQE2285X		500	
R5CQE2286X		600	
R5CQE2288X	1000	800	
R5CQE22810X		1000	
R5CQE22104X		1000	400
R5CQE22105X			500
R5CQE22106X			600
R5CQE22108X			800
R5CQE221010X	1200	1000	
R5CQE22124X		400	
R5CQE22125X		500	
R5CQE22126X		600	
R5CQE22128X		800	
R5CQE221210X		1000	

■ Armadi per quadri elettrici componibili CQE

CQE modular enclosure

Armadio con porta in vetro serigrafato e retro

Modular Cabinets with Screen-Printed Glazed Door and rear panel



IP55

Telaio

struttura assemblata con profilo chiuso in acciaio zincato sp. 15/10 verniciato RAL 7035 bucciato.

Tetto e base

lamiera d'acciaio sp. 15/10 verniciati RAL 7011 bucciato, asportabili.

Fondo

lamiera d'acciaio zincato sp. 15/10 con ingresso cavi regolabile.

Retro

lamiera d'acciaio sp. 15/10 verniciato RAL 7035 bucciato e 8 punti di fissaggio alla struttura.

Porta

lamiera d'acciaio sp. 20/10 verniciata RAL 7035 bucciato. 4 punti di chiusura, 4 cerniere e mostrina con inserto di chiusura tipo aletta doppio pettine Ø3 mm. Vetro di sicurezza serigrafato fumè sp. 40/10.

Grado di resistenza all'urto secondo IEC EN 62208; EN50102: IK09.

Composizione

telaio, tetto, base, fondo, retro e porta in vetro serigrafato.

Structure

Assembled of a closed profile manufactured of 15/10 thick steel, painted textured RAL 7035.

Roof and base

Manufactured of 15/10 thick steel, painted textured RAL 7011, removable.

Bottom

15/10 thick galvanized steel, adjustable cable gland.

Rear panel

15/10 thick steel, painted textured RAL 7035 and 8 points of fastening to the structure.

Door

20/10 thick steel, painted textured RAL 7035. 4 closing points, 4 hinges and an escutcheon with a double-bit lock insert Ø3 mm. 40/10 thick safety screen-printed smoked glass.

Impact resistance degree as per IEC EN 62208; EN50102: IK09.

Composition

Structure, roof, base, bottom, rear panel and screen-printed glazed door.

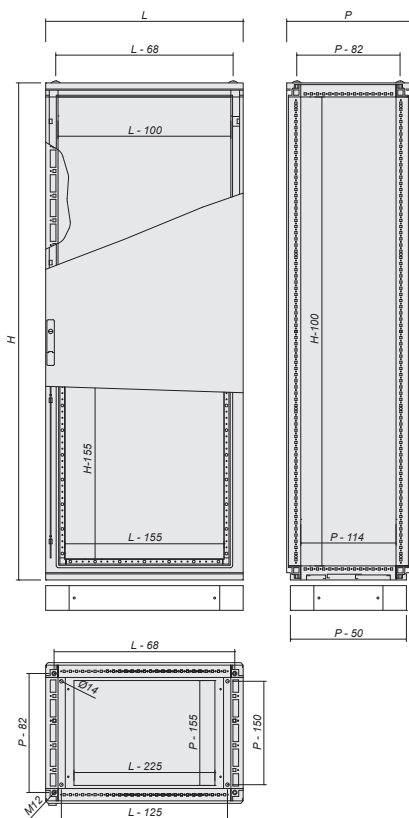

H 1600

CODICE CODE	LARGHEZZA (mm) WIDTH (mm)	DIMENSIONI, MM DIMENSIONS, MM	
		PROFONDITÀ (mm) DEPTH (mm)	
R5CQE1664V		400	
R5CQE1665V	600	500	
R5CQE1666V		600	
R5CQE1684V		400	
R5CQE1685V	800	500	
R5CQE1686V		600	

H 1800

CODICE CODE	LARGHEZZA (mm) WIDTH (mm)	DIMENSIONI, MM DIMENSIONS, MM	
		PROFONDITÀ (mm) DEPTH (mm)	
R5CQE1863V		300	
R5CQE1864V		400	
R5CQE1865V	600	500	
R5CQE1866V		600	
R5CQE1868V		800	
R5CQE18610V		1000	
R5CQE1883V		300	
R5CQE1884V		400	
R5CQE1885V	800	500	
R5CQE1886V		600	
R5CQE1888V		800	

■ Armadi per quadri elettrici componibili CQE

CQE modular enclosure

Armadio con porta in vetro serigrafato e retro

Modular Cabinets with Screen-Printed Glazed Door and rear panel



H 1800

CODICE CODE	LARGHEZZA (mm) WIDTH (mm)	DIMENSIONI, MM DIMENSIONS, MM	
		PROFONDITÀ (mm) DEPTH (mm)	
R5CQE18810V	800	1000	

H 2000

CODICE CODE	LARGHEZZA (mm) WIDTH (mm)	DIMENSIONI, MM DIMENSIONS, MM	
		PROFONDITÀ (mm) DEPTH (mm)	
R5CQE2063V	600	300	
R5CQE2064V		400	
R5CQE2065V		500	
R5CQE2066V		600	
R5CQE2068V		800	
R5CQE20610V		1000	
R5CQE2083V	800	300	
R5CQE2084V		400	
R5CQE2085V		500	
R5CQE2086V		600	
R5CQE2088V		800	
R5CQE20810V		1000	

■ Armadi per quadri elettrici componibili CQE

CQE modular enclosure

Armadio ad angolo

Corner enclosure



- Struttura ricavata sulla base degli armadi serie CQE, verniciata RAL 7035 bucciato.
- Tetto e base verniciati RAL 7011 bucciato.
- Fornito di 2 cornici per unire gli armadi ai lati e completo di 2 pannelli posteriori asportabili.
- Articolo fornibile a richiesta.
- In fase di ordine specificare altezza, larghezza e profondità.
- Pannello di cablaggio (articolo speciale) da ordinare a parte.
- Grado di protezione IP 55 secondo EN 60529/IEC EN 62208.

Per le tempistiche di consegna concordarsi con la rete commerciale.

- Structure made on the basis of CQE series enclosures, painted textured RAL 7035.
- Roof and base painted textured RAL 7011.
- Complete with 2 frames for joining enclosures at the sides and 2 removable rear panels.
- Available upon request.
- The required height, width and depth are to be specified during the order.
- Mounting panel (customized product) is to be ordered separately.
- IP55 protection degree as per EN 60529/IEC EN 62208.

For delivery times agree with the commercial network.

H 1800

CODICE CODE	DIMENSIONI, MM DIMENSIONS, MM	
	LARGHEZZA (mm) WIDTH (mm)	PROFONDITÀ (mm) DEPTH (mm)
R5CQEA1855	500	500
R5CQEA1866	600	600
R5CQEA1888	800	800

H 2000

CODICE CODE	DIMENSIONI, MM DIMENSIONS, MM	
	LARGHEZZA (mm) WIDTH (mm)	PROFONDITÀ (mm) DEPTH (mm)
R5CQEA2055	500	500
R5CQEA2066	600	600
R5CQEA2088	800	800

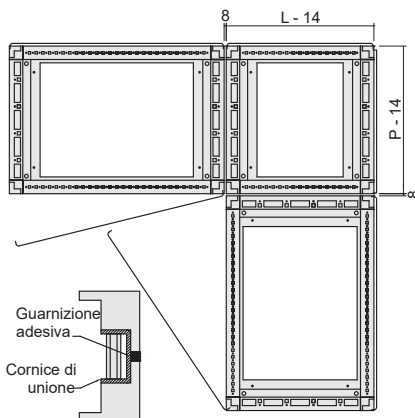

■ Armadi per quadri elettrici componibili CQE

CQE modular enclosure

Zoccolo per quadro ad angolo

Plinth for corner enclosure



H 100

CODICE CODE	DIMENSIONI, MM DIMENSIONS, MM	
	LARGHEZZA (mm) WIDTH (mm)	PROFONDITÀ (mm) DEPTH (mm)
R1ZEA551	500	500
R1ZEA661	600	600
R1ZEA881	800	800

H 200

CODICE CODE	DIMENSIONI, MM DIMENSIONS, MM	
	LARGHEZZA (mm) WIDTH (mm)	PROFONDITÀ (mm) DEPTH (mm)
R1ZEA552	500	500
R1ZEA662	600	600
R1ZEA882	800	800



 DKC

Armadio portacomputer CQEC
CQEC PC enclosures

 **DKC**

■ Armadio portacomputer CQEC

CQEC PC enclosures

Caratteristiche Generali

General characteristics



Gli armadi per computer modello CQEC, ricavati direttamente dagli armadi serie CQE, sono nati per soddisfare l'esigenza di utilizzo di computer in ambienti industriali, pur mantenendo un grado di protezione IP elevato (IP55 secondo EN 60529/IEC EN 62208).

La totale compatibilità con gli armadi serie CQE e con i suoi componenti quali porte, pannelli laterali, ripiani interni ecc., consentono una grande riduzione dei costi di magazzino. Gli armadi portacomputer CQEC possono essere accoppiati ai nostri armadi standard CQE.

La linea di armadi per computer CQEC è costruita in tre altezze (1600, 1800 e 2000) con un'unica larghezza (600) e due profondità (600 e 800), in versione porta superiore a vetro o in versione porta superiore in lamiera cieca.



Armadio

- Struttura assemblata con profilo chiuso brevettato in acciaio sp.15/10 verniciato RAL 7035 bucciato.
- Tetto e base asportabili in acciaio sp.15/10 verniciati RAL7011 bucciato
- Portina parziale superiore cieca o con finestra trasparente protetta da vetro di sicurezza serigrafato sp. 4mm
- Ripiano porta monitor
- Ripiano estraibile per ospitare tastiera e mouse
- Porta parziale inferiore
- Porta posteriore unica

La parte inferiore dell'armadio è predisposta per l'alloggiamento del case e delle altre periferiche quali modem, stampante, switch.

Accessori di completamento

- Coppia montanti RACK 19" – 16 HE per il 1600 e 18HE per il 1800-2000
- Ripiani porta apparecchiature fissi o estraibili

Pannello di cablaggio

- H600 mm (H reale 570 per il 1600) RZPCE6600
- H800 mm (H reale 770 per il 1800-2000) RZPCE6800

NOTA

Armadi disponibili in 7 giorni lavorativi

Nel caso in cui venga ordinata una carpenteria CQE con colore diverso dallo standard, la procedura prevede che lo stesso colore venga realizzato anche per i pannelli di base, quadro e tetto.

CQEC PC enclosures deriving directly from CQE series enclosures have been conceived to meet the necessity to use computers in industrial environments though keeping a high protection degree (IP55 as per EN 60529/IEC EN 62208).

A full compatibility with CQE series enclosures and their components, such as doors, side panels, internal trays etc., permit a considerable reduction of stock cost. CQEC PC enclosures may be combined with our standard CQE enclosures.

CQEC PC enclosures line is constituted by 3 height options (1600, 1800 and 2000) with the only width (600) and two depth options (600 and 800), available with a glazed upper door or blank steel door.

Enclosure

- structure assembled of a patented closed profile manufactured of 15/10 thick steel, painted textured RAL 7035
- removable roof and base manufactured of 15/10 thick steel painted textured RAL 7011;
- upper partial blank door or glazed window door with safety screen-printed 4 mm thick glass; Ripiano porta monitor
- display support tray;
- lower partial door;
- single rear door

The lower part of the enclosure is prepared to accommodate a case and other peripheral devices, such as modems, printers, switches.

Accessories

- a pair of RACK 19" uprights – 16 HE for height 1600 and 18 HE for height 1800 – 2000;
- support fixed and sliding trays for instruments

Mounting panel

- H600 mm (real H 570 for the 1600) RZPCE6600
- H800 mm (real H 770 for the 1800-2000) RZPCE6800

NOTE

Cabinet available in 7 working days

In case you order a CQE enclosure with a different color from the standard, the procedure require that the same color is also applied to the base, panel and roof.



■ Armadio portacomputer CQEC

CQEC PC enclosures

Caratteristiche Tecniche

Technical characteristics

Conformità e omologazioni

Conformity and approvals



- **IP 55** in accordo con IEC EN 62208; EN 60529
- Grado di protezione garantito dalla guarnizione in schiuma poliuretana bi-componente
- Grado di resistenza all'urto **IK10** in accordo con IEC EN 62208; EN 50102 per la versione porta cieca e **IK09** in accordo con IEC EN 62208; EN 50102 per la versione porta trasparente.

Protection degree

- **IP 55** according to IEC EN 62208; EN 60529
- The protection degree is guaranteed by a seal of two-component polyurethane foam
- Impact resistance degree **IK10** as per IEC EN 62208; EN 50102 for the version with a blank door and **IK09** as per IEC EN 62208; EN 50102 for the version with a glazed door.

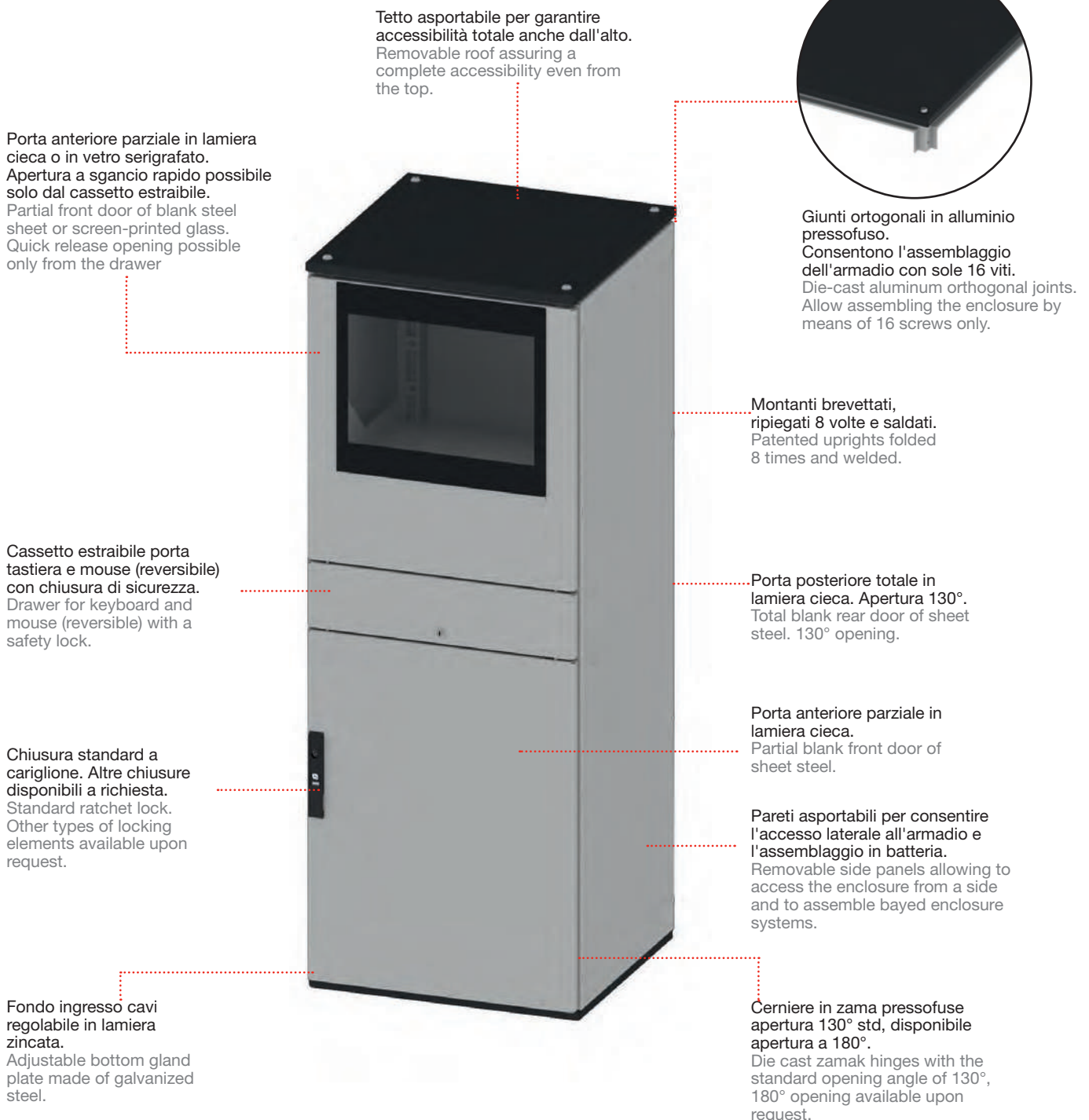

■ Armadi porta computer industriali CQEC PC computer

Armadio porta computer CQEC porta vetro serigrafato CQEC PC Enclosure with screen-printed glazed door



IP55

Struttura

Assemblata con profilo chiuso in acciaio sp.15/10 verniciato RAL 7035 bucciato.

Tetto e base

Asportabili in acciaio sp.15/10 verniciati RAL7011 bucciato.

Portina superiore

Portina superiore con finestra trasparente protetta da vetro di sicurezza serigrafato sp.4mm.

L'armadio comprende: ripiano porta monitor, ripiano estraibile per mouse e tastiera, porta inferiore e porta posteriore.

Grado di resistenza meccanica secondo IEC EN 62208: IK09

N.B. Il grado di protezione IP55 si riferisce all'armadio completo di laterali. Laterali da ordinare separatamente.

Structure

Assembled with a closed profile in 15/10 thick galvanized steel painted with RAL 7035, textured finish.

Roof and base

Made of 15/10 thick steel, painted with RAL 7011, textured finish. Removable.

Upper door

Upper door with transparent window protected by 4mm thick screen-printed security glass.

The enclosure includes: display support tray, extractable for keyboard and mouse, lower door and rear door.

Mechanical resistance degree as per IEC EN 62208: IK09.

N.B. IP55 protection degree refers to enclosures complete with side panels. Side panel to be ordered separately.

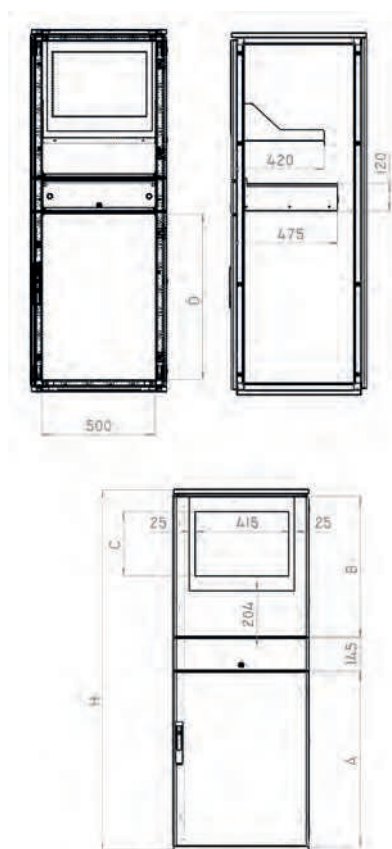

H 1600

CODICE CODE	LARGHEZZA (mm) WIDTH (mm)	PROFONDITÀ (mm) DEPTH (mm)	DIMENSIONI, MM DIMENSIONS, MM			
			A A	B B	C C	D D
R5CQEC1666	600	600	775	625	285	735
R5CQEC1668	600	800				

H 1800

CODICE CODE	LARGHEZZA (mm) WIDTH (mm)	PROFONDITÀ (mm) DEPTH (mm)	DIMENSIONI, MM DIMENSIONS, MM			
			A A	B B	C C	D D
R5CQEC1866	600	600	875	725	385	835
R5CQEC1868	600	800				

H 2000

CODICE CODE	LARGHEZZA (mm) WIDTH (mm)	PROFONDITÀ (mm) DEPTH (mm)	DIMENSIONI, MM DIMENSIONS, MM			
			A A	B B	C C	D D
R5CQEC2066	600	600	875	925	585	835
R5CQEC2068	600	800				

■ Armadi porta computer industriali CQEC PC computer

Armadio porta computer CQEC porta cieca CQEC PC Enclosure with blank door



IP55

Struttura

Struttura assemblata con profilo chiuso in acciaio sp.15/10 verniciato RAL 7035 bucciato.

Tetto e base

Asportabili in acciaio sp.15/10 verniciati RAL7011 bucciato.

Portina superiore

Portina superiore in lamiera cieca.

L'armadio comprende: ripiano porta monitor, ripiano estraibile per mouse e tastiera, porta inferiore e porta posteriore.

Grado di resistenza meccanica secondo IEC EN 62208: IK10

N.B. Il grado di protezione IP55 si riferisce all'armadio completo di laterali.

Structure

Assembled structure with a closed profile in 15/10 thick galvanized steel painted with RAL 7035, textured finish.

Roof and base

Made of 15/10 thick steel, painted with RAL 7011, textured finish. Removable.

Upper door

Made of blank steel sheet.

The enclosure includes: display support tray, extractable for keyboard and mouse, lower door and rear door.

Mechanical resistance degree as per IEC EN 62208: IK10.

N.B. IP55 protection degree refers to enclosures complete with side panels.

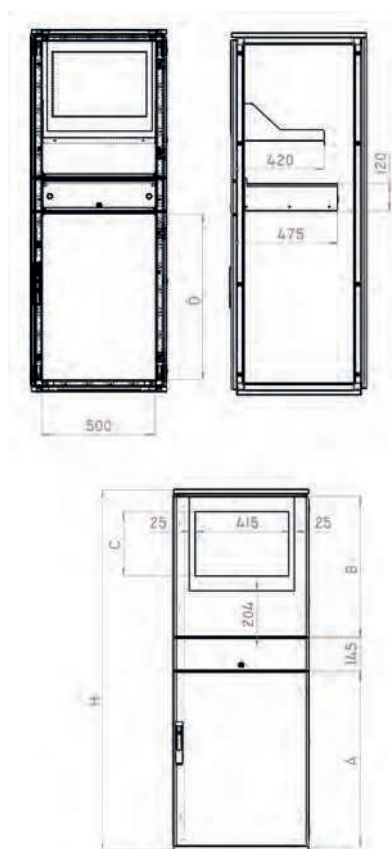

H 1600

CODICE CODE	LARGHEZZA (mm) WIDTH (mm)	PROFONDITÀ (mm) DEPTH (mm)	DIMENSIONI, MM DIMENSIONS, MM			
			A A	B B	C C	D D
R5CQEC1666P	600	600	775	625	285	735
R5CQEC1668P	600	800				

H 1800

CODICE CODE	LARGHEZZA (mm) WIDTH (mm)	PROFONDITÀ (mm) DEPTH (mm)	DIMENSIONI, MM DIMENSIONS, MM			
			A A	B B	C C	D D
R5CQEC1866P	600	600	875	725	385	835
R5CQEC1868P	600	800				

H 2000

CODICE CODE	LARGHEZZA (mm) WIDTH (mm)	PROFONDITÀ (mm) DEPTH (mm)	DIMENSIONI, MM DIMENSIONS, MM			
			A A	B B	C C	D D
R5CQEC2066P	600	600	875	925	585	835
R5CQEC2068P	600	800				

■ Armadi porta computer industriali CQEC PC computer

Montante rack 19" Upright for 19 inch rack



Coppia montanti rack in lamiera sp.20/10 verniciati RAL7035 bucciato.

Accessori di fissaggio inclusi nella confezione.

Per il posizionamento è necessario l'impiego di 1 confezione di TLE in base alla profondità (montaggio previsto solo in basso).

Made of 20/10 thick steel, painted with RAL 7035, textured finish.

Fastening accessories are included.

In order to install the uprights it is necessary to use 1 pack of TLE depending on the depth (mounting only in the lower part).

H 1600

CODICE CODE	DIMENSIONI, MM DIMENSIONS, MM
	HE HE
R5MRE8	16

H 1800-2000

CODICE CODE	DIMENSIONI, MM DIMENSIONS, MM
	HE HE
R5MRE9	18

■ Armadi porta computer industriali

CQEC PC computer

Zoccolo per CQEC

CQEC plinth

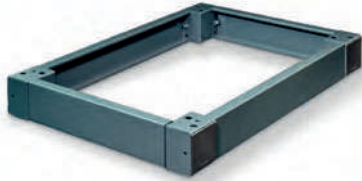

Gli zoccoli sono realizzati abbinando:
angolare + flangia frontale + flangia laterale

- Angolare realizzato in lamiera d'acciaio sp. 25/10 verniciato RAL 7011 bucciato
- Flange frontali e laterali in lamiera d'acciaio sp. 15/10 verniciato RAL 7011 bucciato
- Completo di viteria per il montaggio

The plinths are made by combining:
angular + front flange + side flange.

- Angular sheet steel sp. 25/10 painted with RAL 7011, textured finish.
- Front and side flanges in steel sheet sp. 15/10 painted with RAL 7011, textured finish.
- Complete with mounting bolts and screws

H 100



Codice Code	ANGOLARE ANGULAR	ZOCOLO H.200 PLINTH H.200 FLANGIA FRONTALE FRONT FLANGE	FLANGIA LATERALE SIDE FLANGE
R5CQEC1666			R1ZPRO601
R5CQEC1666P			
R5CQEC1668			R1ZPRO801
R5CQEC1668P			
R5CQEC1866			R1ZPRO601
R5CQEC1866P	R1ZCOR1	R1ZPRO601	
R5CQEC1868			R1ZPRO801
R5CQEC1868P			
R5CQEC2066			R1ZPRO601
R5CQEC2066P			
R5CQEC2068			R1ZPRO801
R5CQEC2068P			

H 200



Codice Code	ANGOLARE ANGULAR	ZOCOLO H.200 PLINTH H.200 FLANGIA FRONTALE FRONT FLANGE	FLANGIA LATERALE SIDE FLANGE
R5CQEC1666			R1ZPRO602
R5CQEC1666P			
R5CQEC1668	R1ZCOR2	R1ZPRO602	R1ZPRO802
R5CQEC1668P			
R5CQEC1866			R1ZPRO602
R5CQEC1866P			

■ Armadi porta computer industriali

CQEC PC computer

Zoccolo per CQEC

CQEC plinth



H 200



Codice Code	ANGOLARE ANGULAR	ZOCCOLO H.200 PLINTH H.200 FLANGIA FRONTALE FRONT FLANGE	FLANGIA LATERALE SIDE FLANGE
R5CQEC1868			R1ZPRO802
R5CQEC1868P			
R5CQEC2066	R1ZCOR2	R1ZPRO602	R1ZPRO602
R5CQEC2066P			
R5CQEC2068			R1ZPRO802
R5CQEC2068P			

■ Armadi porta computer industriali

CQEC PC computer

Pannello di cablaggio

Mounting panel



Costruito in lamiera zincata sp. 20/10.

Accessori di fissaggio inclusi nella confezione.

Per il posizionamento è necessario l'impiego di 1 confezione di TLE in base alla profondità (montaggio previsto solo in basso).

Made of 20/10 thick galvanized steel.

Fastening accessories are included.

In order to install the panel it is necessary to use 1 pack of TLE depending on the depth (mounting only in the lower part).

H 600

CODICE CODE	DIMENSIONI, MM DIMENSIONS, MM		E E
	LARGHEZZA (mm) WIDTH (mm)		
RZPCE6600	600		600

H 800

CODICE CODE	DIMENSIONI, MM DIMENSIONS, MM		E E
	LARGHEZZA (mm) WIDTH (mm)		
RZPCE6800	600		800

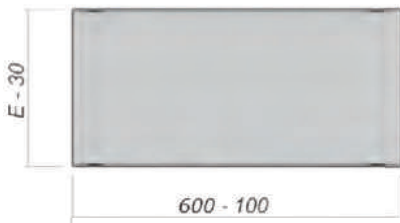



Carpenterie EMC
EMC carpentry

■ Carpenterie EMC

EMC carpentry

Caratteristiche Characteristics



La serie di carpenterie EMC è stata appositamente sviluppata per applicazioni in cui si rende necessaria una protezione dai disturbi elettromagnetici degli apparecchi installati.

Questi disturbi potrebbero alterare o compromettere il funzionamento delle apparecchiature e quindi si rende necessario un involucro con funzione schermante nei confronti delle interferenze elettromagnetiche.

La gamma EMC di DKC prevede:

- L'armadio componibile CQE in esecuzione ad anta singola cieca con la possibilità, tramite apposito kit, di realizzare soluzioni in batteria. L'armadio prevede di serie il fondo unico per una maggiore protezione schermante. Le misure disponibili prevedono altezza 2.000mm, larghezze 600 e 800mm e profondità 600 e 800mm.
- La cassa serie CE in esecuzione ad anta singola cieca. La cassa viene fornita di serie con fondo chiuso e con chiusura metallica per una maggiore protezione schermante. Le misure disponibili prevedono altezze 400 e 600mm, larghezze 400 e 600mm e profondità 200 e 250mm.
- La cassetta di derivazione serie CDE con coperchio avvitato. Le misure disponibili prevedono altezze 300 e 500mm, larghezza 300mm e profondità 120mm. Tutta la serie di esecuzioni EMC è adatta ad installazione INDOOR ed è realizzata con lamiere zincate SENDZIMIR, verniciatura con polvere poliester e epossidica (ad esclusione delle zone di contatto tra le parti) e guarnizioni conduttive in neoprene espanso.

I materiali della serie EMC sono stati testati secondo la norma EN 61000-5-7:2001 "Electromagnetic compatibility (EMC) - Part 5-7: Installation and mitigation guidelines Degrees of protection provided by enclosures against electromagnetic disturbances (EM code)"

The EMC carpentry series has been specially developed for applications in which there is a need for protection from electromagnetic interference of the installed equipment.

These disturbances could alter or impair the operation of the equipment and therefore it becomes necessary an enclosure with a function shielding against interference electromagnetic.

DKC's EMC range includes:

- The CQE modular enclosure in single blind door execution with the possibility, via special kit, to realize battery solutions. The cabinet includes as standard the single bottom for a greater shielding protection. The available sizes include height 2,000mm, widths 600 and 800mm and depths 600 and 800mm.
- The CE series case in door execution single blind. The crate comes as standard standard with a closed bottom and with locking metal for increased protection shielding. Available sizes include heights 400 and 600mm, widths 400 and 600mm and depths 200 and 250mm.
- The CDE series junction box with screwon lid. The available sizes provide for heights 300 and 500mm, 300mm width and 120mm depth. The entire series of EMC executions is suitable for INDOOR installation and is made with SENDZIMIR galvanized sheet metal, painted with polyester powder epoxy (except for the areas of contact between parts) and gaskets conductive neoprene foam.

The materials in the EMC series have been tested according to EN 61000-5-7:2001. "Electromagnetic compatibility (EMC).

- Part 5-7: Installation and mitigation guidelines Degrees of protection provided by enclosures against electromagnetic disturbances (EM code)"

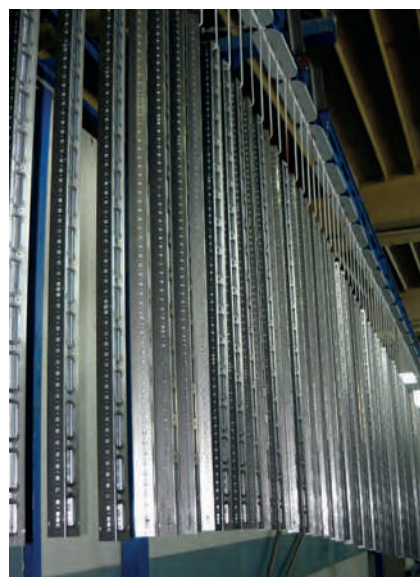

Conformità e omologazioni Conformity and approvals



Grado di protezione

- **IP 43/44** in accordo con IEC EN 62208; EN 60529
- Grado di protezione garantito dalla guarnizione in tessuto conduttivo e anima in neoprene
- Grado di resistenza all'urto **IK10** in accordo con IEC EN 62208; EN 50102

Protection degree

- **IP 55** according to IEC EN 62208; EN 60529
- The protection degree is guaranteed by a seal of conductive material and neoprene core
- Impact resistance degree **IK10** as per IEC EN 62208; EN 50102

■ Carpenterie EMC

Carpenterie EMC

Armadio EMC

EMC cabinet



IP43

Dimensioni

Realizzabili con altezza 2000 mm, larghezza 600- 800 mm e profondità 600 - 800 mm.

Dimensions

Can be manufactured with height 2000 mm, width 600-800 mm and depth 600 -800 mm.

H 2000

CODICE CODE	DIMENSIONI, MM DIMENSIONS, MM	
	LARGHEZZA (mm) WIDTH (mm)	PROFONDITÀ (mm) DEPTH (mm)
R5CQEMC2066	600	600
R5CQEMC2068	600	800
R5CQEMC2086	800	600
R5CQEMC2088	800	800

Campo magnetico

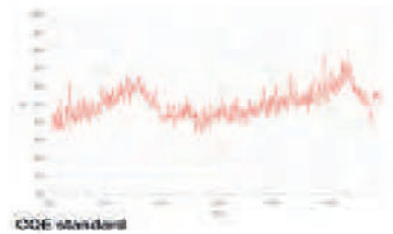
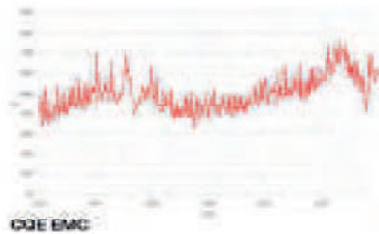

Campo elettrico

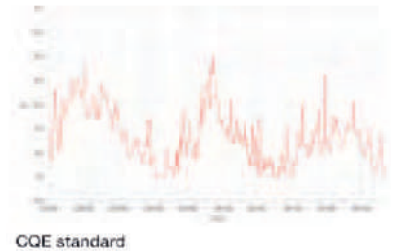
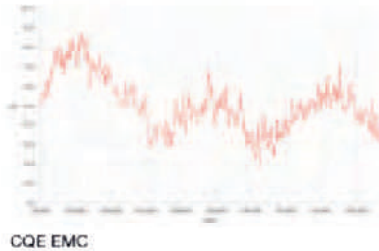

■ Carpenterie EMC

Carpenterie EMC

Kit unione armadi Baying kit



Kit unione armadi EMC, confezione completa di 8 distanziatori. Guarnizione adesiva conduttiva. Completo di accessori per il montaggio.

EMC baying kit. The supply includes 8 spacers. Adhesive conductive seal. Complete with mounting accessories.

CODICE CODE	DIMENSIONI, MM DIMENSIONS, MM CONFEZIONI/PZ PACK/PCS
RZKEMC65	4

Laterali per armadio EMC Side panels for EMC cabinet



Dimensioni

Realizzabili con altezza 1961 mm, larghezza 546-746 mm.

Dimensions

Can be manufactured with height 1961mm, width 546-746 mm.

H 2000

CODICE CODE	DIMENSIONI, MM DIMENSIONS, MM PROFONDITÀ (mm) DEPTH (mm)
R5LEMC2062	600
R5LEMC2082	800

■ Carpenterie EMC

Carpenterie EMC

Casse serie CE EMC

EMC Boxes



IP44

Dimensioni

Realizzabili con altezza 400 mm, larghezza 400 mm e profondità 200 mm.

Realizzabili con altezza 600 mm, larghezza 400-600 mm e profondità 200-250 mm.

Dimensions

Can be manufactured with height 400 mm, width 400 mm and depth 600 mm.

Achievable with height 600 mm, width 400-600 mm and depth 200-250 mm.

H 400

CODICE CODE	DIMENSIONI, MM DIMENSIONS, MM	
	LARGHEZZA (mm) WIDTH (mm)	PROFONDITÀ (mm) DEPTH (mm)
R5CEMC0442	400	200

H 600

CODICE CODE	DIMENSIONI, MM DIMENSIONS, MM	
	LARGHEZZA (mm) WIDTH (mm)	PROFONDITÀ (mm) DEPTH (mm)
R5CEMC0642	400	200
R5CEMC0669	600	250

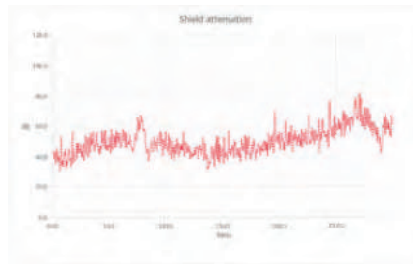

■ Carpenterie EMC

Carpenterie EMC

Cassa di derivazione EMC

EMC Junction Boxes



IP44

Dimensioni

Realizzabili con altezza 300-500 mm, larghezza 300 mm e profondità 120 mm.

Dimensions

Achievable with height 300-500 mm, width 300 mm and depth 120 mm.

H 300

CODICE CODE	LARGHEZZA (mm) WIDTH (mm)	DIMENSIONI, MM DIMENSIONS, MM	PROFONDITÀ (mm) DEPTH (mm)
R5CDEMC33120	300		120

H 500

CODICE CODE	LARGHEZZA (mm) WIDTH (mm)	DIMENSIONI, MM DIMENSIONS, MM	PROFONDITÀ (mm) DEPTH (mm)
R5CDEMC53120	300		120

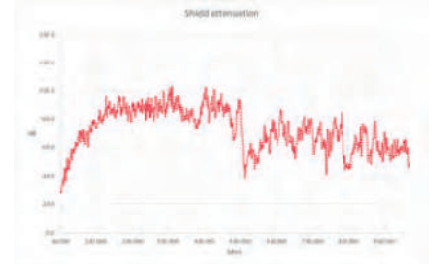
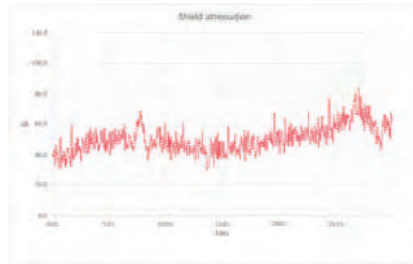



Armadio monoblocco semplificato CAES
CAES simplified monobloc enclosures

■ Armadio monoblocco semplificato CAES

CAES simplified monobloc enclosures

Per installazione indoor For indoor installation



La linea di armadi monoblocco semplificato CAES è costituita da sei altezze standard, da 1000 a 2000 mm. per un totale di 11 misure disponibili.

La verniciatura viene eseguita di serie con polveri epossipoliestere, colore standard RAL 7035 bucciato.

Il ciclo di verniciatura standard applicato è classificabile, secondo la norma UNI ISO 12944-2018, come C3 con durabilità M.

Struttura

- Lamiera d'acciaio spessore 15/10 con saldatura continua sulle giunzioni.
- Chiusura fondo con tre flange asportabili

Porta

- In lamiera d'acciaio spessore 20/10
- Telaio interno forato con passo 25mm
- Guarnizione perimetrale poliuretanic, applicata in colata continua
- Previste quattro cerniere in zama con angolo di apertura 130°
- Previsti quattro punti di chiusura
- Possibilità di montaggio sia frontale, sia posteriore

Pannello di cablaggio

- In lamiera d'acciaio zincata SENDZIMIR®, spessore 25/10
- Bordatura perimetrale da "U" da 25mm

Pannello posteriore

- In lamiera d'acciaio spessore 15/10

The line of CAES simplified monobloc cabinets consists of six standard heights, from 1000 to 2000 mm. for a total of 11 sizes available.

The painting is carried out as standard with epoxy-polyester powders, standard color RAL 7035 textured.

The applied standard painting cycle can be classified, according to UNI ISO 12944-2018, as C3 with durability M.

Structure

- 15/10 thick steel sheet with continuous welding on the joints.
- Bottom closure with three removable flanges

Door

- 20/10 thick sheet steel
- Perforated internal frame with 25mm pitch
- Perimeter polyurethane gasket, applied in continuous casting
- Provided with four zamak hinges with 130° opening angle
- Four closing points provided
- Possibility of front and rear mounting

Wiring panel

- In SENDZIMIR® galvanized steel sheet, thickness 25/10
- Perimeter "U" border of 25mm

Back panel

- 15/10 thick sheet steel

■ Armadio monoblocco semplificato CAES

CAES simplified monobloc enclosures

Caratteristiche Characteristics

Conformità e omologazioni Conformity and approvals



- **IP 55** in accordo con IEC EN 62208; EN 60529
- Grado di protezione garantito dalla guarnizione in schiuma poliuretana bi-componente

Protection degree

- **IP 55** according to IEC EN 62208; EN 60529
- The protection degree is guaranteed by a seal of two-component polyurethane foam

Retro asportabile universale per serie CAES, CAE e CQE
Universal removable rear for CAES, CAE and CQE series

Struttura complementare saldata per garantire la massima resistenza alle sollecitazioni meccaniche
Complementary structure welded to ensure maximum resistance to mechanical stress

Telaio saldato alla struttura per garantire la massima resistenza alle sollecitazioni meccaniche
Frame welded to the structure to ensure maximum resistance to mechanical stress



Porta frontale con telaio di rinforzo di serie, universale per serie CAES, CAE e CQE
Front door with reinforcement frame as standard, universal for CAES, CAE and CQE series

Chiusura standard a cariglione
Standard locking mechanism

Fondo ingresso cavi in lamiera zincata
Bottom cable entry in galvanized sheet

■ CAES Armadio monoblocco semplificato

CAES simplified welded enclosure

Armadio CAES porta cieca

Compact Simplified Cabinet Blank Door



Struttura:

- Lamiera d'acciaio spessore 15/10 verniciatura RAL 7035 epossipoliestere bucciato.
- Guarnizione interna in schiuma poliuretana bi-componente.

Nota

Tempo di evasione 4 giorni lavorativi.

Characteristics

- 15/10 thick steel sheet structure, painted in textured epoxy-polyester, RAL 7035.
- Internal foam seal made in twincomponent polyurethane.

Note

Available in 4 working days

H 1000

CODICE CODE	LARGHEZZA (mm) WIDTH (mm)	DIMENSIONI, MM	PROFONDITÀ (mm) DEPTH (mm)
		DIMENSIONS, MM	
R5CAES1084	800		400

H 1200

CODICE CODE	LARGHEZZA (mm) WIDTH (mm)	DIMENSIONI, MM	PROFONDITÀ (mm) DEPTH (mm)
		DIMENSIONS, MM	
R5CAES12104	1000		400

H 1400

CODICE CODE	LARGHEZZA (mm) WIDTH (mm)	DIMENSIONI, MM	PROFONDITÀ (mm) DEPTH (mm)
		DIMENSIONS, MM	
R5CAES1484	800		400

H 1600

CODICE CODE	LARGHEZZA (mm) WIDTH (mm)	DIMENSIONI, MM	PROFONDITÀ (mm) DEPTH (mm)
		DIMENSIONS, MM	
R5CAES1663			300
R5CAES1664	600		
R5CAES1684	800		400
R5CAES16104	1000		

H 1800

CODICE CODE	LARGHEZZA (mm) WIDTH (mm)	DIMENSIONI, MM	PROFONDITÀ (mm) DEPTH (mm)
		DIMENSIONS, MM	
R5CAES1884			400
R5CAES1885	800		500
R5CAES18104	1000		400

H 2000

CODICE CODE	LARGHEZZA (mm) WIDTH (mm)	DIMENSIONI, MM	PROFONDITÀ (mm) DEPTH (mm)
		DIMENSIONS, MM	
R5CAES2084	800		400

■ CAES Armadio monoblocco semplificato

CAES simplified welded enclosure

Armadio CAES pannello di cablaggio

Simplified mounting plate for CAES cabinet



- In lamiera d'acciaio spessore 25/10, zincato Sendzimir.
- Aumentato lo spessore delle pieghe laterali 25 e 30 mm a favore di una maggiore robustezza.
- Dimensioni del pannello di cablaggio aumentate: ottimizzazione dello spazio di installazione e incremento dello spazio utile tra pannello di cablaggio e porta.
- Mounting panel in 25/10 thick, Sendzimir galvanised steel sheet.
- The thickness of the side folds has been increased from 25 to 30 mm for greater sturdiness.
- Mounting panel dimensions increased: the installation space has been optimised and the available usable space between the mounting panel

H 1000

CODICE CODE	DIMENSIONI, MM DIMENSIONS, MM LARGHEZZA (mm) WIDTH (mm)
RZPCES1080	800

H 1200

CODICE CODE	DIMENSIONI, MM DIMENSIONS, MM LARGHEZZA (mm) WIDTH (mm)
RZPCES12100	1000

H 1400

CODICE CODE	DIMENSIONI, MM DIMENSIONS, MM LARGHEZZA (mm) WIDTH (mm)
RZPCES1480	800

H 1600

CODICE CODE	DIMENSIONI, MM DIMENSIONS, MM LARGHEZZA (mm) WIDTH (mm)
RZPCES1660	600
RZPCES1680	800
RZPCES16100	1000

H 1800

CODICE CODE	DIMENSIONI, MM DIMENSIONS, MM LARGHEZZA (mm) WIDTH (mm)
RZPCES1880	800
RZPCES18100	1000

H 2000

CODICE CODE	DIMENSIONI, MM DIMENSIONS, MM LARGHEZZA (mm) WIDTH (mm)
RZPCES2080	800

■ CAES Armadio monoblocco semplificato

CAES simplified welded enclosure

Zoccolo modulare per CAES

Modular plinth for CAES

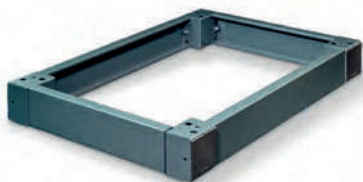

Gli zoccoli sono realizzati abbinando:
angolare + flangia frontale + flangia laterale

- Angolare realizzato in lamiera d'acciaio sp. 25/10 verniciato RAL 7011 bucciato
- Flange frontali e laterali in lamiera d'acciaio sp. 15/10 verniciato RAL 7011 bucciato
- Completo di viteria per il montaggio

The plinths are made by matching: angular + front flange + side flange.

- Angular sheet steel sp. 25/10 painted RAL 7011 textured
- Front and side flanges in steel sheet sp. 15/10 painted RAL 7011 textured
- Complete with mounting bolts and screws

H 100



Codice Code	ANGOLARE ANGULAR	ZOCOLO H.200 PLINTH H.200 FLANGIA FRONTALE FRONT FLANGE	FLANGIA LATERALE SIDE FLANGE
R5CAES1084		R1ZPRO801	
R5CAES12104		R1ZPRO1001	
R5CAES1484		R1ZPRO801	R1ZPRO401
R5CAES16104		R1ZPRO1001	
R5CAES1663			R1ZPRO301
R5CAES1664	R1ZCOR1	R1ZPRO601	
R5CAES1684		R1ZPRO801	
R5CAES18104		R1ZPRO1001	R1ZPRO401
R5CAES1884			
R5CAES1885		R1ZPRO801	R1ZPRO501
R5CAES2084			R1ZPRO401

H 200



Codice Code	ANGOLARE ANGULAR	ZOCOLO H.200 PLINTH H.200 FLANGIA FRONTALE FRONT FLANGE	FLANGIA LATERALE SIDE FLANGE
R5CAES1084		R1ZPRO802	
R5CAES12104		R1ZPRO1002	
R5CAES1484		R1ZPRO802	R1ZPRO402
R5CAES16104	R1ZCOR2	R1ZPRO1002	
R5CAES1663			R1ZPRO302
R5CAES1664		R1ZPRO602	
R5CAES1684		R1ZPRO802	R1ZPRO402

■ CAES Armadio monoblocco semplificato

CAES simplified welded enclosure

Zoccolo modulare per CAES
Modular plinth for CAES



H 200



Codice Code	ANGOLARE ANGULAR	ZOCCOLO H.200 PLINTH H.200 FLANGIA FRONTALE FRONT FLANGE	FLANGIA LATERALE SIDE FLANGE
R5CAES18104		R1ZPRO1002	R1ZPRO402
R5CAES1884	R1ZCOR2		
R5CAES1885		R1ZPRO802	R1ZPRO502
R5CAES2084			R1ZPRO402



Armadio monoblocco saldato CAE
CAE welded compact enclosure

■ Armadio monoblocco saldato CAE

CAE welded compact enclosure

Caratteristiche Characteristics



La linea di armadi CAE è costituita da sette altezze standard, da 800 a 2000mm. La verniciatura viene eseguita di serie con polveri epossipoliestere, colore standard RAL 7035 bucciato con tetto, base e zoccolo RAL 7011 bucciato. Il ciclo di verniciatura standard applicato è classificabile, secondo la norma UNI ISO 12944-2018, come C3 con durabilità M. Il grado di protezione dell'armadio CAE è IP55 in versione standard. Secondo determinate condizioni tecniche e con utilizzo del Fondo Unico, è elevabile ad IP65.

The line of CAE monobloc cabinets consists of seven standard heights, ranging from 1000 to 2000 mm. Painting is carried out as a standard with epoxy-polyester powders, RAL 7035 textured standard colour with RAL 7011 textured roof, base and plinth. The applied standard painting cycle can be classified, in accordance with UNI ISO 12944-2018, as C3 with durability M. The degree of protection of the CAE cabinet is IP55 in the standard version. Under certain technical conditions and with the use of the Single Fund, it can be raised to IP65.



Struttura

- Lamiera d'acciaio spessore 15/10 con saldatura continua sulle giunzioni.
- Chiusura fondo con tre flange asportabili

Structure

- 15/10 thick steel sheet with continuous welding on the joints. .
- Bottom closure with three removable-flanges



Porta

- In lamiera d'acciaio spessore 20/10
- Telaio interno forato con passo 25mm
- Guarnizione perimetrale poliuretanic, applicata in colata continua
- Previste quattro cerniere in zama con angolo di apertura 130°
- Previsti quattro punti di chiusura
- Possibilità di montaggio sia frontale, sia posteriore

Door

- 20/10 thick steel sheet
- Perforated internal frame with 25mm pitch
- Perimeter polyurethane gasket, applied in continuous casting
- Provided with four zamak hinges with 130° opening angle
- Four closing points provided
- Possibility of front and rear mounting

Pannello di cablaggio

- In lamiera d'acciaio zincata SENDZIMIR®, spessore 25/10
- Bordatura perimetrale da "U" da 25 mm
- Possibilità di montaggio arretrato, allineato ai montanti posteriori, tramite apposito kit
- Possibilità di montaggio di due piastre contrapposte

Wiring panel

- In SENDZIMIR® galvanized steel sheet, thickness 25/10
- 25mm "U" perimeter edging
- Possibility of backward mounting, aligned to the rear uprights, via dedicated kit
- Possibility of mounting two opposite plates

Pannelli laterali

- In lamiera d'acciaio spessore 15/10

Side panels

- 15/10 thick steel sheet

Pannello posteriore

- In lamiera d'acciaio spessore 15/10

Rear panel

- 15/10 thick steel sheet

■ Armadio monoblocco saldato CAE

CAE welded compact enclosure

Caratteristiche

Characteristics

Conformità e omologazioni

Conformity and approvals

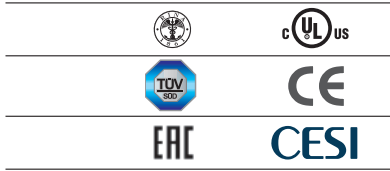

- **IP 55** in accordo con IEC EN 62208; EN 60529
- **TYPE 4** in accordo con UL508A; UL50 (singola anta cieca)
- **TYPE 12** in accordo con UL508A; UL50 (doppia anta cieca)
- Grado di protezione garantito dalla guarnizione in schiuma poliuretana bi-componente
- Grado di resistenza all'urto **IK10** in accordo con IEC EN 62208; EN 62262

Protection degree

- **IP 55** according to IEC EN 62208; EN 60529
- **TYPE 4** according to UL508A; UL50 (single blind door)
- **TYPE 12** according to UL508A; UL50 (double blind door)
- The protection degree is guaranteed by a seal of two-component polyurethane foam
- Impact resistance degree **IK10** according to IEC EN 62208; EN 62262



Tetto saldato alla struttura per garantire la massima resistenza alle sollecitazioni meccaniche.
Roof welded to the structure assuring maximum resistance against mechanical stress.

Retro asportabile universale per serie CQE e CAE.
Removable rear panel universal for CQE and CAE series.

Struttura portante completamente saldata per garantire la massima resistenza alle sollecitazioni meccaniche.
Entirely welded support structure assuring maximum resistance against mechanical stress

Porta anteriore con telaio di rinforzo di serie, universale per serie CQE e CAE.
Front door with standard reinforcement frame, universal for CQE and CAE.

Chiusura standard a cariglione. Altre chiusure disponibili a richiesta.
Standard ratchet lock. Other types of locking elements available upon request.

Fondo ingresso cavi regolabile in lamiera zincata.
Adjustable bottom gland plate made of galvanized steel.

Cerniere in zama pressofuse apertura 130° std, disponibile apertura a 180°.
Die-cast zamak hinges with the standard opening angle of 130°, 180° opening is available upon request.

■ Armadio monoblocco saldato CAE per quadro elettrico per applicazioni indoor CAE welded enclosure

Versione montata Assembled version

H 1000



SOLO STRUTTURA
STRUCTURE ONLY



STRUTTURA E RETRO
STRUCTURE AND REAR PANEL



STRUTTURA, RETRO E PORTA
CIECA
STRUCTURE, REAR PANEL AND
GLASS DOOR



STRUTTURA, RETRO E PORTA
TRASPARENTE
STRUCTURE, REAR PANEL AND
GLASS DOOR



STRUTTURA, RETRO E PORTA IN
VETRO SERIGRAFATO
STRUCTURE, REAR PANEL AND
SCREEN-PRINTED GLASS DOOR

DIMENSIONI ARMADIO ENCLOSURE DIMENSIONS					
L W	P D				
600	300	R5CAE1063S	R5CAE1063R	R5CAE1063	R5CAE1063X
	400	R5CAE1064S	R5CAE1064R	R5CAE1064	R5CAE1064X
800	300	R5CAE1083S	R5CAE1083R	R5CAE1083	R5CAE1083X
	400	R5CAE1084S	R5CAE1084R	R5CAE1084	R5CAE1084X
1000	300	R5CAE10103S	R5CAE10103R	R5CAE10103	R5CAE10103X
	400	R5CAE10104S	R5CAE10104R	R5CAE10104	R5CAE10104X

* Tetto con flangia / Roof with a flange
** Armadio con doppia anta / Doble door cabinet

Accessori correlati Related accessories

Montanti
Uprights



Pag.

Pannelli di cablaggio
Mounting Panels



Pag. 126

Porte
Doors



Pag. 168

Retro
Rear Panel



Pag. 189

Laterali
Side panels



Pag. 191

■ Armadio monoblocco saldato CAE per quadro elettrico per applicazioni indoor CAE welded enclosure

Versione montata
Assembled version

H 1000



DIMENSIONI ARMADIO ENCLOSURE DIMENSIONS		PANNELLO CABLAGGIO MOUNTING PANEL	PORTA INTERNA INTERNAL DOOR	ZOCOLO H.100 PLINTH H.100			ZOCOLO H.200 PLINTH H.200		
L W	P D			ANGOLARE ANGULAR	FLANGIA FRONTALE FRONT FLANGE	FLANGIA LATERALE SIDE FLANGE	ANGOLARE ANGULAR	FLANGIA FRONTALE FRONT FLANGE	FLANGIA LATERALE SIDE FLANGE
600	300	RZPCE1060	R5PIE1060	R1ZCOR1	R1ZPRO601	R1ZPRO301	R1ZCOR2	R1ZPRO602	R1ZPRO302
	400					R1ZPRO401			R1ZPRO402
800	300	RZPCE1080	R5PIE1080		R1ZPRO801	R1ZPRO301		R1ZPRO802	R1ZPRO302
	400					R1ZPRO401			R1ZPRO402
1000	300	RZPCE10100	R5PIE10100		R1ZPRO1001	R1ZPRO301		R1ZPRO1002	R1ZPRO302
	400					R1ZPRO401			R1ZPRO402

* Tetto con flangia / Roof with a flange
** Armadio con doppia anta / Doble door cabinet

Accessori correlati Related accessories

Zocchi
Plinth

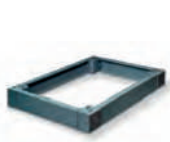

Pag. 150

Chiusure
Locking elements



Pag. 187

Profili
Profiles



Pag. 207

Telai rack 19"
Rack 19"



Pag. 216

Accessori per sollevamento
Lifting accessories



Pag. 232

■ Armadio monoblocco saldato CAE per quadro elettrico per applicazioni indoor CAE welded enclosure

Versione montata Assembled version

H 1200



SOLO STRUTTURA
STRUCTURE ONLY

STRUTTURA E RETRO
STRUCTURE AND REAR PANEL

STRUTTURA, RETRO E PORTA
CIECA
STRUCTURE, REAR PANEL AND
GLASS DOOR

STRUTTURA, RETRO E PORTA
TRASPARENTE
STRUCTURE, REAR PANEL AND
GLASS DOOR

STRUTTURA, RETRO E PORTA IN
VETRO SERIGRAFATO
STRUCTURE, REAR PANEL AND
SCREEN-PRINTED GLASS DOOR

DIMENSIONI ARMADIO ENCLOSURE DIMENSIONS					
L W	P D				
600	300	R5CAE1263S	R5CAE1263R	R5CAE1263	R5CAE1263X
	400	R5CAE1264S	R5CAE1264R	R5CAE1264	R5CAE1264X
800	300	R5CAE1283S	R5CAE1283R	R5CAE1283	R5CAE1283X
	400	R5CAE1284S	R5CAE1284R	R5CAE1284	R5CAE1284X
1000	300	R5CAE12103S	R5CAE12103R	R5CAE12103	R5CAE12103X
	400	R5CAE12104S	R5CAE12104R	R5CAE12104	R5CAE12104X

* Tetto con flangia / Roof with a flange
** Armadio con doppia anta / Doble door cabinet

Accessori correlati Related accessories

Montanti
Uprights



Pag.

Pannelli di cablaggio
Mounting Panels



Pag. 126

Porte
Doors



Pag. 168

Retro
Rear Panel



Pag. 189

Laterali
Side panels



Pag. 191

■ Armadio monoblocco saldato CAE per quadro elettrico per applicazioni indoor CAE welded enclosure

Versione montata
Assembled version

H 1200



DIMENSIONI ARMADIO ENCLOSURE DIMENSIONS		PANNELLO CABLAGGIO MOUNTING PANEL	PORTA INTERNA INTERNAL DOOR	ZOCOLO H.100 PLINTH H.100			ZOCOLO H.200 PLINTH H.200		
L W	P D			ANGOLARE ANGULAR	FLANGIA FRONTALE FRONT FLANGE	FLANGIA LATERALE SIDE FLANGE	ANGOLARE ANGULAR	FLANGIA FRONTALE FRONT FLANGE	FLANGIA LATERALE SIDE FLANGE
600	300	RZPCE1260	R5PIE1260		R1ZPRO601	R1ZPRO301		R1ZPRO602	R1ZPRO302
	400					R1ZPRO401			R1ZPRO402
800	300	RZPCE1280	R5PIE1280	R1ZCOR1	R1ZPRO801	R1ZPRO301	R1ZCOR2	R1ZPRO802	R1ZPRO302
	400					R1ZPRO401			R1ZPRO402
1000	300	RZPCE12100	R5PIE12100		R1ZPRO1001	R1ZPRO301		R1ZPRO1002	R1ZPRO302
	400					R1ZPRO401			R1ZPRO402

* Tetto con flangia / Roof with a flange
** Armadio con doppia anta / Doble door cabinet

Accessori correlati Related accessories

Zocchi
Plinth



Pag. 150

Chiusure
Locking elements



Pag. 187

Profili
Profiles



Pag. 207

Telai rack 19"
Rack 19"



Pag. 216

Accessori per sollevamento
Lifting accessories



Pag. 232

■ Armadio monoblocco saldato CAE per quadro elettrico per applicazioni indoor CAE welded enclosure

Versione montata Assembled version

H 1400



DIMENSIONI ARMADIO ENCLOSURE DIMENSIONS		SOLO STRUTTURA STRUCTURE ONLY	STRUTTURA E RETRO STRUCTURE AND REAR PANEL	STRUTTURA, RETRO E PORTA CIECA STRUCTURE, REAR PANEL AND GLASS DOOR	STRUTTURA, RETRO E PORTA TRASPARENTE STRUCTURE, REAR PANEL AND GLASS DOOR	STRUTTURA, RETRO E PORTA IN VETRO SERIGRAFATO STRUCTURE, REAR PANEL AND SCREEN-PRINTED GLASS DOOR
L W	P D					
600	300	R5CAE1463S	R5CAE1463R	R5CAE1463	R5CAE1463X	
	400	R5CAE1464S	R5CAE1464R	R5CAE1464	R5CAE1464X	
800	300	R5CAE1483S	R5CAE1483R	R5CAE1483	R5CAE1483X	
	400	R5CAE1484S	R5CAE1484R	R5CAE1484	R5CAE1484X	
1000	300	R5CAE14103S	R5CAE14103R	R5CAE14103	R5CAE14103X	
	400	R5CAE14104S	R5CAE14104R	R5CAE14104	R5CAE14104X	

* Tetto con flangia / Roof with a flange
** Armadio con doppia anta / Doble door cabinet

Accessori correlati Related accessories

Montanti
Uprights



Pag.

Pannelli di cablaggio
Mounting Panels



Pag. 126

Porte
Doors



Pag. 168

Retro
Rear Panel



Pag. 189

Laterali
Side panels



Pag. 191

■ Armadio monoblocco saldato CAE per quadro elettrico per applicazioni indoor CAE welded enclosure

Versione montata
Assembled version

H 1400



DIMENSIONI ARMADIO ENCLOSURE DIMENSIONS		PANNELLO CABLAGGIO MOUNTING PANEL	PORTA INTERNA INTERNAL DOOR	ZOCOLO H.100 PLINTH H.100			ZOCOLO H.200 PLINTH H.200		
L W	P D			ANGOLARE ANGULAR	FLANGIA FRONTALE FRONT FLANGE	FLANGIA LATERALE SIDE FLANGE	ANGOLARE ANGULAR	FLANGIA FRONTALE FRONT FLANGE	FLANGIA LATERALE SIDE FLANGE
600	300	RZPCE1460	R5PIE1460	R1ZCOR1	R1ZPRO601	R1ZPRO301	R1ZCOR2	R1ZPRO602	R1ZPRO302
	400					R1ZPRO401			R1ZPRO402
800	300	RZPCE1480	R5PIE1480		R1ZPRO801	R1ZPRO301		R1ZPRO802	R1ZPRO302
	400					R1ZPRO401			R1ZPRO402
1000	300	RZPCE14100	R5PIE14100		R1ZPRO1001	R1ZPRO301		R1ZPRO1002	R1ZPRO302
	400					R1ZPRO401			R1ZPRO402

* Tetto con flangia / Roof with a flange
** Armadio con doppia anta / Doble door cabinet

Accessori correlati Related accessories

Zocchi
Plinth



Pag. 150

Chiusure
Locking elements



Pag. 187

Profili
Profiles



Pag. 207

Telai rack 19"
Rack 19"



Pag. 216

Accessori per sollevamento
Lifting accessories



Pag. 232

■ Armadio monoblocco saldato CAE per quadro elettrico per applicazioni indoor CAE welded enclosure

Versione montata Assembled version

H 1600



SOLO STRUTTURA
STRUCTURE ONLY



STRUTTURA E RETRO
STRUCTURE AND REAR PANEL



STRUTTURA, RETRO E PORTA
CIECA
STRUCTURE, REAR PANEL AND
GLASS DOOR



STRUTTURA, RETRO E PORTA
TRASPARENTE
STRUCTURE, REAR PANEL AND
GLASS DOOR



STRUTTURA, RETRO E PORTA IN
VETRO SERIGRAFATO
STRUCTURE, REAR PANEL AND
SCREEN-PRINTED GLASS DOOR

DIMENSIONI ARMADIO ENCLOSURE DIMENSIONS						
L W	P D					
600	300	R5CAE1663S	R5CAE1663R	R5CAE1663	R5CAE1663X	R5CAE1663V
	400	R5CAE1664S	R5CAE1664R	R5CAE1664	R5CAE1664X	R5CAE1664V
800	300	R5CAE1683S	R5CAE1683R	R5CAE1683	R5CAE1683X	R5CAE1683V
	400	R5CAE1684S	R5CAE1684R	R5CAE1684	R5CAE1684X	R5CAE1684V
1000	300	R5CAE16103S	R5CAE16103R	R5CAE16103	R5CAE16103X	-
	400	R5CAE16104S	R5CAE16104R	R5CAE16104	R5CAE16104X	-

* Tetto con flangia / Roof with a flange
** Armadio con doppia anta / Doble door cabinet

Accessori correlati Related accessories

Montanti
Uprights



Pag.

Pannelli di cablaggio
Mounting Panels



Pag. 126

Porte
Doors



Pag. 168

Retro
Rear Panel



Pag. 189

Laterali
Side panels



Pag. 191

■ Armadio monoblocco saldato CAE per quadro elettrico per applicazioni indoor CAE welded enclosure

Versione montata
Assembled version

H 1600



DIMENSIONI ARMADIO ENCLOSURE DIMENSIONS		PANNELLO CABLAGGIO MOUNTING PANEL	PORTA INTERNA INTERNAL DOOR	ZOCOLO H.100 PLINTH H.100			ZOCOLO H.200 PLINTH H.200		
L W	P D			ANGOLARE ANGULAR	FLANGIA FRONTALE FRONT FLANGE	FLANGIA LATERALE SIDE FLANGE	ANGOLARE ANGULAR	FLANGIA FRONTALE FRONT FLANGE	FLANGIA LATERALE SIDE FLANGE
600	300	RZPCE1660	R5PIE1660		R1ZPRO601	R1ZPRO301	R1ZCOR2	R1ZPRO602	R1ZPRO302
	400					R1ZPRO401			R1ZPRO402
800	300	RZPCE1680	R5PIE1680	R1ZCOR1	R1ZPRO801	R1ZPRO301	R1ZCOR2	R1ZPRO802	R1ZPRO302
	400					R1ZPRO401			R1ZPRO402
1000	300	RZPCE16100	R5PIE16100		R1ZPRO1001	R1ZPRO301		R1ZPRO1002	R1ZPRO302
	400					R1ZPRO401			R1ZPRO402

* Tetto con flangia / Roof with a flange
** Armadio con doppia anta / Doble door cabinet

Accessori correlati Related accessories

Zocchi
Plinth

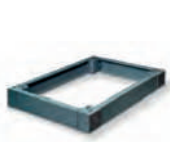

Pag. 150

Chiusure
Locking elements



Pag. 187

Profili
Profiles



Pag. 207

Telai rack 19"
Rack 19"



Pag. 216

Accessori per sollevamento
Lifting accessories



Pag. 232

■ Armadio monoblocco saldato CAE per quadro elettrico per applicazioni indoor CAE welded enclosure

Versione montata Assembled version

H 1800



SOLO STRUTTURA
STRUCTURE ONLY



STRUTTURA E RETRO
STRUCTURE AND REAR PANEL



STRUTTURA, RETRO E PORTA
CIECA
STRUCTURE, REAR PANEL AND
GLASS DOOR



STRUTTURA, RETRO E PORTA
TRASPARENTE
STRUCTURE, REAR PANEL AND
GLASS DOOR



STRUTTURA, RETRO E PORTA IN
VETRO SERIGRAFATO
STRUCTURE, REAR PANEL AND
SCREEN-PRINTED GLASS DOOR

DIMENSIONI ARMADIO ENCLOSURE DIMENSIONS						
L W	P D					
600	300	R5CAE1863S	R5CAE1863R	R5CAE1863	R5CAE1863X	R5CAE1863V
	400	R5CAE1864S	R5CAE1864R	R5CAE1864	R5CAE1864X	R5CAE1864V
	500	R5CAE1865S	R5CAE1865R	R5CAE1865	R5CAE1865X	R5CAE1865V
	600	R5CAE1866S	R5CAE1866R	R5CAE1866	R5CAE1866X	R5CAE1866V
800	300	R5CAE1883S	R5CAE1883R	R5CAE1883	R5CAE1883X	R5CAE1883V
	400	R5CAE1884S	R5CAE1884R	R5CAE1884	R5CAE1884X	R5CAE1884V
	500	R5CAE1885S	R5CAE1885R	R5CAE1885	R5CAE1885X	R5CAE1885V
	600	R5CAE1886S	R5CAE1886R	R5CAE1886	R5CAE1886X	R5CAE1886V
1000	400	R5CAE18104S	R5CAE18104R	R5CAE18104	R5CAE18104X	
	500	R5CAE18105S	R5CAE18105R	R5CAE18105	R5CAE18105X	
	600	R5CAE18106S	R5CAE18106R	R5CAE18106	R5CAE18106X	
**1200	400	R5CAE18124S	R5CAE18124R	R5CAE18124		
	500	R5CAE18125S	R5CAE18125R	R5CAE18125		
	600	R5CAE18126S	R5CAE18126R	R5CAE18126		

* Tetto con flangia / Roof with a flange
** Armadio con doppia anta / Doble door cabinet

Accessori correlati Related accessories

Montanti
Uprights



Pag.

Pannelli di cablaggio
Mounting Panels



Pag. 126

Porte
Doors



Pag. 168

Retro
Rear Panel



Pag. 189

Laterali
Side panels



Pag. 191

■ Armadio monoblocco saldato CAE per quadro elettrico per applicazioni indoor CAE welded enclosure

Versione montata
Assembled version

H 1800



DIMENSIONI ARMADIO ENCLOSURE DIMENSIONS		PANNELLO CABLAGGIO MOUNTING PANEL	PORTA INTERNA INTERNAL DOOR	ZOCOLO H.100 PLINTH H.100			ZOCOLO H.200 PLINTH H.200		
L W	P D			ANGOLARE ANGULAR	FLANGIA FRONTALE FRONT FLANGE	FLANGIA LATERALE SIDE FLANGE	ANGOLARE ANGULAR	FLANGIA FRONTALE FRONT FLANGE	FLANGIA LATERALE SIDE FLANGE
600	300	RZPCE1860	R5PIE1860	R1ZCOR1	R1ZPRO601	R1ZPRO301	R1ZCOR2	R1ZPRO602	R1ZPRO302
	400					R1ZPRO401			R1ZPRO402
	500					R1ZPRO501			R1ZPRO502
	600					R1ZPRO601			R1ZPRO602
800	300	RZPCE1880	R5PIE1880	R1ZCOR1	R1ZPRO801	R1ZPRO301	R1ZCOR2	R1ZPRO802	R1ZPRO302
	400					R1ZPRO401			R1ZPRO402
	500					R1ZPRO501			R1ZPRO502
	600					R1ZPRO601			R1ZPRO602
1000	400	RZPCE18100	R5PIE18100	R1ZCOR1	R1ZPRO1001	R1ZPRO401	R1ZCOR2	R1ZPRO1002	R1ZPRO402
	500					R1ZPRO501			R1ZPRO502
	600					R1ZPRO601			R1ZPRO602
**1200	400	RZPCE18120	R5PIE18120	R1ZCOR1	R1ZPRO1201	R1ZPRO401	R1ZCOR2	R1ZPRO1202	R1ZPRO402
	500					R1ZPRO501			R1ZPRO502
	600					R1ZPRO601			R1ZPRO602

* Tetto con flangia / Roof with a flange
** Armadio con doppia anta / Doble door cabinet

Accessori correlati Related accessories

Zocchi
Plinth

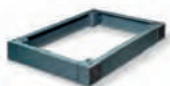

Pag. 150

Chiusure
Locking elements



Pag. 187

Profili
Profiles



Pag. 207

Telai rack 19"
Rack 19"



Pag. 216

Accessori per sollevamento
Lifting accessories



Pag. 232

■ Armadio monoblocco saldato CAE per quadro elettrico per applicazioni indoor CAE welded enclosure

Versione montata Assembled version

H 2000



SOLO STRUTTURA
STRUCTURE ONLY



STRUTTURA E RETRO
STRUCTURE AND REAR PANEL



STRUTTURA, RETRO E PORTA
CIECA
STRUCTURE, REAR PANEL AND
GLASS DOOR



STRUTTURA, RETRO E PORTA
TRASPARENTE
STRUCTURE, REAR PANEL AND
GLASS DOOR



STRUTTURA, RETRO E PORTA IN
VETRO SERIGRAFATO
STRUCTURE, REAR PANEL AND
SCREEN-PRINTED GLASS DOOR

DIMENSIONI ARMADIO ENCLOSURE DIMENSIONS						
L W	P D					
600	300	R5CAE2063S	R5CAE2063R	R5CAE2063	R5CAE2063X	R5CAE2063V
	400	R5CAE2064S	R5CAE2064R	R5CAE2064	R5CAE2064X	R5CAE2064V
	500	R5CAE2065S	R5CAE2065R	R5CAE2065	R5CAE2065X	R5CAE2065V
	600	R5CAE2066S	R5CAE2066R	R5CAE2066	R5CAE2066X	R5CAE2066V
800	300	R5CAE2083S	R5CAE2083R	R5CAE2083	R5CAE2083X	R5CAE2083V
	400	R5CAE2084S	R5CAE2084R	R5CAE2084	R5CAE2084X	R5CAE2084V
	500	R5CAE2085S	R5CAE2085R	R5CAE2085	R5CAE2085X	R5CAE2085V
	600	R5CAE2086S	R5CAE2086R	R5CAE2086	R5CAE2086X	R5CAE2086V
1000	400	R5CAE20104S	R5CAE20104R	R5CAE20104	R5CAE20104X	
	500	R5CAE20105S	R5CAE20105R	R5CAE20105	R5CAE20105X	
	600	R5CAE20106S	R5CAE20106R	R5CAE20106	R5CAE20106X	
**1200	400	R5CAE20124S	R5CAE20124R	R5CAE20124		
	500	R5CAE20125S	R5CAE20125R	R5CAE20125		
	600	R5CAE20126S	R5CAE20126R	R5CAE20126		

* Tetto con flangia / Roof with a flange
** Armadio con doppia anta / Doble door cabinet

Accessori correlati Related accessories

Montanti
Uprights



Pag.

Pannelli di cablaggio
Mounting Panels



Pag. 126

Porte
Doors



Pag. 168

Retro
Rear Panel



Pag. 189

Laterali
Side panels



Pag. 191

■ Armadio monoblocco saldato CAE per quadro elettrico per applicazioni indoor CAE welded enclosure

Versione montata
Assembled version

H 2000



DIMENSIONI ARMADIO ENCLOSURE DIMENSIONS		PANNELLO CABLAGGIO MOUNTING PANEL	PORTA INTERNA INTERNAL DOOR	ZOCOLO H.100 PLINTH H.100			ZOCOLO H.200 PLINTH H.200		
L W	P D			ANGOLARE ANGULAR	FLANGIA FRONTALE FRONT FLANGE	FLANGIA LATERALE SIDE FLANGE	ANGOLARE ANGULAR	FLANGIA FRONTALE FRONT FLANGE	FLANGIA LATERALE SIDE FLANGE
600	300	RZPCE2060	R5PIE2060	R1ZCOR1	R1ZPRO601	R1ZPRO301	R1ZCOR2	R1ZPRO602	R1ZPRO302
	400					R1ZPRO401			R1ZPRO402
	500					R1ZPRO501			R1ZPRO502
	600					R1ZPRO601			R1ZPRO602
800	300	RZPCE2080	R5PIE2080	R1ZCOR1	R1ZPRO801	R1ZPRO301	R1ZCOR2	R1ZPRO802	R1ZPRO302
	400					R1ZPRO401			R1ZPRO402
	500					R1ZPRO501			R1ZPRO502
	600					R1ZPRO601			R1ZPRO602
1000	400	RZPCE20100	R5PIE20100	R1ZCOR1	R1ZPRO1001	R1ZPRO401	R1ZCOR2	R1ZPRO1002	R1ZPRO402
	500					R1ZPRO501			R1ZPRO502
	600					R1ZPRO601			R1ZPRO602
**1200	400	RZPCE20120	R5PIE20120	R1ZCOR1	R1ZPRO1201	R1ZPRO401	R1ZCOR2	R1ZPRO1202	R1ZPRO402
	500					R1ZPRO501			R1ZPRO502
	600					R1ZPRO601			R1ZPRO602

* Tetto con flangia / Roof with a flange
** Armadio con doppia anta / Doble door cabinet

Accessori correlati Related accessories

Zocchi
Plinth



Pag. 150

Chiusure
Locking elements



Pag. 187

Profili
Profiles



Pag. 207

Telai rack 19"
Rack 19"



Pag. 216

Accessori per sollevamento
Lifting accessories



Pag. 232

■ Armadio monoblocco saldato CAE per quadro elettrico per applicazioni indoor CAE welded enclosure

Armadio monoblocco CAE - Solo struttura CAE Compact Cabinet - Structure only

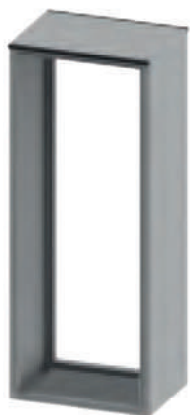

IP55

Struttura

Chiusa lateralmente e superiormente in lamiera d'acciaio sp. 15/10 verniciata RAL7035 epossipoliestere bucciato e fondo con ingresso cavi regolabile.

Grado di protezione

TYPE 4 con porta singola anta cieca.

TYPE 12 con porta doppia anta cieca. (da L 1200).

Il grado di protezione IP/TYPE riportato nella tabella sottostante si riferisce all'armadio completo di porta e retro.

Structure

Assembled structure with a closed profile in 15/10 thick galvanized steel painted with RAL 7035, textured finish.

Protection degree

TYPE 4 with single blind door.

TYPE 12 with double blind door. (from L 1200)

The IP/TYPE degree of protection refers to the cabinet/battery of cabinets complete with doors and rear.

H 1000

CODICE CODE	DIMENSIONI, MM DIMENSIONS, MM	
	LARGHEZZA (mm) WIDTH (mm)	PROFONDITÀ (mm) DEPTH (mm)
R5CAE1063S	600	300
R5CAE1064S	600	400
R5CAE1083S	800	300
R5CAE1084S	800	400
R5CAE10103S	1000	300
R5CAE10104S	1000	400

H 1200

CODICE CODE	DIMENSIONI, MM DIMENSIONS, MM	
	LARGHEZZA (mm) WIDTH (mm)	PROFONDITÀ (mm) DEPTH (mm)
R5CAE1263S	600	300
R5CAE1264S	600	400
R5CAE1283S	800	300
R5CAE1284S	800	400
R5CAE12103S	1000	300
R5CAE12104S	1000	400

H 1400

CODICE CODE	DIMENSIONI, MM DIMENSIONS, MM	
	LARGHEZZA (mm) WIDTH (mm)	PROFONDITÀ (mm) DEPTH (mm)
R5CAE1463S	600	300
R5CAE1464S	600	400
R5CAE1483S	800	300
R5CAE1484S	800	400
R5CAE14103S	1000	300
R5CAE14104S	1000	400

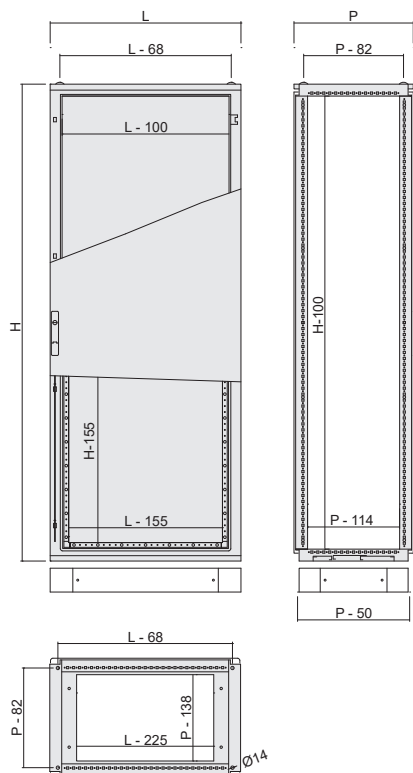

■ Armadio monoblocco saldato CAE per quadro elettrico per applicazioni indoor CAE welded enclosure

Armadio monoblocco CAE - Solo struttura CAE Compact Cabinet - Structure only

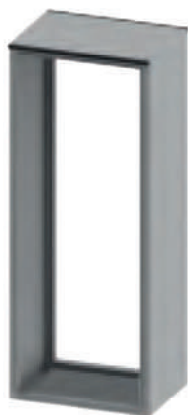

H 1600

CODICE CODE	LARGHEZZA (mm) WIDTH (mm)	DIMENSIONI, MM DIMENSIONS, MM
		PROFONDITÀ (mm) DEPTH (mm)
R5CAE1663S	600	300
R5CAE1664S		400
R5CAE1683S	800	300
R5CAE1684S		400
R5CAE16103S	1000	300
R5CAE16104S		400

H 1800

CODICE CODE	LARGHEZZA (mm) WIDTH (mm)	DIMENSIONI, MM DIMENSIONS, MM
		PROFONDITÀ (mm) DEPTH (mm)
R5CAE1863S	600	300
R5CAE1864S		400
R5CAE1865S		500
R5CAE1866S		600
R5CAE1883S	800	300
R5CAE1884S		400
R5CAE1885S		500
R5CAE1886S		600
R5CAE18104S	1000	400
R5CAE18105S		500
R5CAE18106S		600
R5CAE18124S		400
R5CAE18125S	1200	500
R5CAE18126S		600

H 2000

CODICE CODE	LARGHEZZA (mm) WIDTH (mm)	DIMENSIONI, MM DIMENSIONS, MM
		PROFONDITÀ (mm) DEPTH (mm)
R5CAE2063S	600	300
R5CAE2064S		400
R5CAE2065S		500
R5CAE2066S		600
R5CAE2083S	800	300
R5CAE2084S		400
R5CAE2085S		500
R5CAE2086S		600
R5CAE20104S	1000	400
R5CAE20105S		500
R5CAE20106S		600
R5CAE20124S		400
R5CAE20125S	1200	500
R5CAE20126S		600

■ Armadio monoblocco saldato CAE per quadro elettrico per applicazioni indoor CAE welded enclosure

Struttura con retro Rear panel only



IP55

Struttura

Chiusa lateralmente e superiormente in lamiera d'acciaio sp. 15/10 verniciata RAL7035 epossipoliestere bucciato e fondo con ingresso cavi regolabile.

Retro

Lamiera d'acciaio sp. 15/10 verniciato RAL7035 bucciato. Da 4 a 10 punti di fissaggio al telaio.

Porta

Lamiera d'acciaio sp. 20/10 verniciata RAL7035 bucciato. Telaio interno di rinforzo in tubolare zincato. 4 punti di chiusura, 4 cerniere e mostrina con inserto di chiusura tipo aletta doppio pettine Ø 3 mm.

Grado di protezione

TYPE 4 con porta singola anta cieca.

TYPE 12 con porta doppia anta cieca.
(da L 1200).

Il grado di protezione IP/TYPE riportato nella tabella sottostante si riferisce all'armadio completo di porta e retro.

Structure

Assembled structure with a closed profile in 15/10 thick galvanized steel painted with RAL 7035, textured finish.

Rear

Made of 15/10 thick steel, painted with RAL7011, textured finish. From 4 to 10 points of fastening to the structure.

Door

20/10 thick steel, painted textured RAL7035, with rounded safety edges. Complete with an internal reinforcement frame made of galvanized tubular profile, 4 closing points, 4 hinges and an escutcheon with a Ø3 mm double-bit lock insert.

Protection degree

TYPE 4 with single blind door.

The IP/TYPE degree of protection refers to the cabinet/battery of cabinets complete with doors and rear.

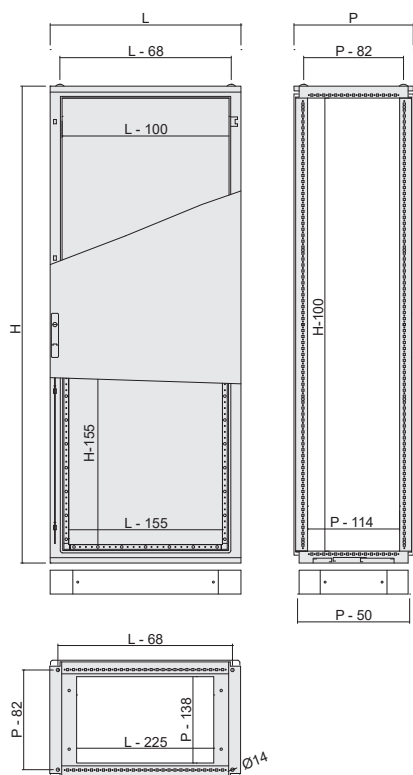

H 1000

CODICE CODE	DIMENSIONI, MM DIMENSIONS, MM	
	LARGHEZZA (mm) WIDTH (mm)	PROFONDITÀ (mm) DEPTH (mm)
R5CAE1063R	600	300
R5CAE1064R	600	400
R5CAE1083R	800	300
R5CAE1084R	800	400
R5CAE10103R	1000	300
R5CAE10104R	1000	400

H 1200

CODICE CODE	DIMENSIONI, MM DIMENSIONS, MM	
	LARGHEZZA (mm) WIDTH (mm)	PROFONDITÀ (mm) DEPTH (mm)
R5CAE1263R	600	300
R5CAE1264R	600	400
R5CAE1283R	800	300
R5CAE1284R	800	400
R5CAE12103R	1000	300
R5CAE12104R	1000	400

■ Armadio monoblocco saldato CAE per quadro elettrico per applicazioni indoor CAE welded enclosure

Struttura con retro
Rear panel only



H 1400

CODICE CODE	LARGHEZZA (mm) WIDTH (mm)	DIMENSIONI, MM DIMENSIONS, MM
		PROFONDITÀ (mm) DEPTH (mm)
R5CAE1463R	600	300
R5CAE1464R		400
R5CAE1483R	800	300
R5CAE1484R		400
R5CAE14103R	1000	300
R5CAE14104R		400

H 1600

CODICE CODE	LARGHEZZA (mm) WIDTH (mm)	DIMENSIONI, MM DIMENSIONS, MM
		PROFONDITÀ (mm) DEPTH (mm)
R5CAE1663R	600	300
R5CAE1664R		400
R5CAE1683R	800	300
R5CAE1684R		400
R5CAE16103R	1000	300
R5CAE16104R		400

H 1800

CODICE CODE	LARGHEZZA (mm) WIDTH (mm)	DIMENSIONI, MM DIMENSIONS, MM
		PROFONDITÀ (mm) DEPTH (mm)
R5CAE1863R	600	300
R5CAE1864R		400
R5CAE1865R		500
R5CAE1866R		600
R5CAE1883R		300
R5CAE1884R		400
R5CAE1885R	800	500
R5CAE1886R		600
R5CAE18104R		400
R5CAE18105R	1000	500
R5CAE18106R		600
R5CAE18124R		400
R5CAE18125R	1200	500
R5CAE18126R		600

H 2000

CODICE CODE	LARGHEZZA (mm) WIDTH (mm)	DIMENSIONI, MM DIMENSIONS, MM
		PROFONDITÀ (mm) DEPTH (mm)
R5CAE2063R	600	300
R5CAE2064R		400
R5CAE2065R		500
R5CAE2066R		600
R5CAE2083R		300
R5CAE2084R		400
R5CAE2085R	800	500
R5CAE2086R		600
R5CAE20104R		400
R5CAE20105R	1000	500
R5CAE20106R		600

■ Armadio monoblocco saldato CAE per quadro elettrico per applicazioni indoor CAE welded enclosure

Struttura con retro
Rear panel only



H 2000

CODICE CODE	LARGHEZZA (mm) WIDTH (mm)	DIMENSIONI, MM DIMENSIONS, MM	
		PROFONDITÀ (mm) DEPTH (mm)	
R5CAE20124R		400	
R5CAE20125R	1200	500	
R5CAE20126R		600	

■ Armadio monoblocco saldato CAE per quadro elettrico per applicazioni indoor CAE welded enclosure

Armadio monoblocco CAE - Struttura con retro e porta cieca CAE Compact Cabinet - Blank door structure



IP55

Struttura

chiusa lateralmente e superiormente in lamiera d'acciaio sp. 15/10 verniciata RAL 7035 epossipoliestere bucciato e fondo con ingresso cavi regolabile.

Retro

lamiera d'acciaio sp. 15/10 verniciata RAL 7035 bucciato. Da 4 a 10 punti di fissaggio al telaio.

Porta

lamiera d'acciaio sp. 20/10 verniciata RAL 7035 bucciato. Telaio interno di rinforzo in tubolare zincato. 4 punti di chiusura, 4 cerniere e mostrina con inserto di chiusura tipo aletta doppio pettine Ø 3 mm.

Grado di protezione

TYPE 4 con porta singola anta cieca.
TYPE 12 con porta doppia anta cieca. (da L 1200).

Grado di resistenza all'urto secondo IEC EN 62208: IK10

Structure

Solid sides and top, manufactured of 15/10 steel, painted RAL 7035 with textured epoxypolyester, adjustable cable gland bottom.

Rear panel

15/10 thick steel, painted textured RAL 7035. From 4 to 10 points of fastening to the structure.

Door

20/10 thick steel, painted textured RAL 7035. Complete with an internal reinforcement frame made of galvanized tubular profile, 4 closing points, 4 hinges and an escutcheon with Ø3 mm double-bit lock insert.

Protection degree

TYPE 4 with single blind door.
TYPE 12 with double blind door. (from L 1200).

Impact resistance degree as per IEC EN 62208: IK10.

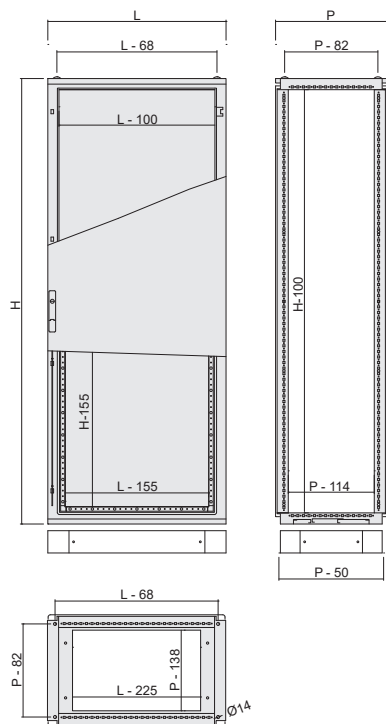

H 1000

CODICE CODE	LARGHEZZA (mm) WIDTH (mm)	DIMENSIONI, MM DIMENSIONS, MM	
			PROFONDITÀ (mm) DEPTH (mm)
R5CAE1063	600		300
R5CAE1064			400
R5CAE1083	800		300
R5CAE1084			400
R5CAE10103	1000		300
R5CAE10104			400

H 1200

CODICE CODE	LARGHEZZA (mm) WIDTH (mm)	DIMENSIONI, MM DIMENSIONS, MM	
			PROFONDITÀ (mm) DEPTH (mm)
R5CAE1263	600		300
R5CAE1264			400
R5CAE1283	800		300
R5CAE1284			400
R5CAE12103	1000		300
R5CAE12104			400

■ Armadio monoblocco saldato CAE per quadro elettrico per applicazioni indoor CAE welded enclosure

Armadio monoblocco CAE - Struttura con retro e porta cieca CAE Compact Cabinet - Blank door structure



H 1400

CODICE CODE	LARGHEZZA (mm) WIDTH (mm)	DIMENSIONI, MM DIMENSIONS, MM
		PROFONDITÀ (mm) DEPTH (mm)
R5CAE1463	600	300
R5CAE1464		400
R5CAE1483	800	300
R5CAE1484		400
R5CAE14103	1000	300
R5CAE14104		400

H 1600

CODICE CODE	LARGHEZZA (mm) WIDTH (mm)	DIMENSIONI, MM DIMENSIONS, MM
		PROFONDITÀ (mm) DEPTH (mm)
R5CAE1663	600	300
R5CAE1664		400
R5CAE1683	800	300
R5CAE1684		400
R5CAE16103	1000	300
R5CAE16104		400

H 1800

CODICE CODE	LARGHEZZA (mm) WIDTH (mm)	DIMENSIONI, MM DIMENSIONS, MM
		PROFONDITÀ (mm) DEPTH (mm)
R5CAE1863	600	300
R5CAE1864		400
R5CAE1865		500
R5CAE1866		600
R5CAE1883		300
R5CAE1884		400
R5CAE1885	800	500
R5CAE1886		600
R5CAE18104		400
R5CAE18105	1000	500
R5CAE18106		600
R5CAE18124		400
R5CAE18125	1200	500
R5CAE18126		600

H 2000

CODICE CODE	LARGHEZZA (mm) WIDTH (mm)	DIMENSIONI, MM DIMENSIONS, MM
		PROFONDITÀ (mm) DEPTH (mm)
R5CAE2063	600	300
R5CAE2064		400
R5CAE2065		500
R5CAE2066		600
R5CAE2083		300
R5CAE2084		400
R5CAE2085	800	500
R5CAE2086		600
R5CAE20104		400
R5CAE20105	1000	500
R5CAE20106		600

■ Armadio monoblocco saldato CAE per quadro elettrico per applicazioni indoor CAE welded enclosure

Armadio monoblocco CAE - Struttura con retro e porta cieca CAE Compact Cabinet - Blank door structure



H 2000

CODICE CODE	LARGHEZZA (mm) WIDTH (mm)	DIMENSIONI, MM DIMENSIONS, MM	
		PROFONDITÀ (mm) DEPTH (mm)	
R5CAE20124		400	
R5CAE20125	1200	500	
R5CAE20126		600	

■ Armadio monoblocco saldato CAE per quadro elettrico per applicazioni indoor CAE welded enclosure

Armadio monoblocco CAE - Struttura con retro e porta trasparente CAE Compact Cabinet - Structure with rear and glass door



IP55

Struttura

Chiusa lateralmente e superiormente in lamiera d'acciaio sp. 15/10 verniciata RAL 7035 epossipoliestere bucciato e fondo con ingresso cavi regolabile.

Retro

Lamiera d'acciaio sp. 15/10 verniciato RAL 7035 bucciato. Da 4 a 10 punti di fissaggio al telaio.

Porta

Lamiera d'acciaio sp. 20/10 verniciata RAL 7035 bucciato. 4 punti di chiusura, 4 cerniere e mostrina con inserto di chiusura tipo aletta doppio pettine Ø3 mm. Vetro di sicurezza sp. 40/10.

Grado di resistenza all'urto secondo IEC EN 62208: IK09

Structure

Solid sides and top, made of 15/10 steel, painted RAL 7035 with textured epoxy polyester, adjustable cable gland bottom.

Rear

15/10 thick steel, painted textured RAL 7035. Ranging from 4 to 10 mounting points to the structure.

Door

20/10 thick steel, painted with textured RAL 7035. Complete with an internal reinforcement frame made of galvanized tubular profile, 4 closing points, 4 hinges and an escutcheon with .3 mm double-bit lock insert. 40/10 thick safety glass.

Impact resistance degree as per IEC EN 62208: IK09

H 1000

CODICE CODE	DIMENSIONI, MM DIMENSIONS, MM	
	LARGHEZZA (mm) WIDTH (mm)	PROFONDITÀ (mm) DEPTH (mm)
R5CAE1063X	600	300
R5CAE1064X	600	400
R5CAE1083X	800	300
R5CAE1084X	800	400
R5CAE10103X	1000	300
R5CAE10104X	1000	400

H 1200

CODICE CODE	DIMENSIONI, MM DIMENSIONS, MM	
	LARGHEZZA (mm) WIDTH (mm)	PROFONDITÀ (mm) DEPTH (mm)
R5CAE1263X	600	300
R5CAE1264X	600	400
R5CAE1283X	800	300
R5CAE1284X	800	400
R5CAE12103X	1000	300
R5CAE12104X	1000	400

H 1400

CODICE CODE	DIMENSIONI, MM DIMENSIONS, MM	
	LARGHEZZA (mm) WIDTH (mm)	PROFONDITÀ (mm) DEPTH (mm)
R5CAE1463X	600	300
R5CAE1464X	600	400
R5CAE1483X	800	300
R5CAE1484X	800	400
R5CAE14103X	1000	300
R5CAE14104X	1000	400

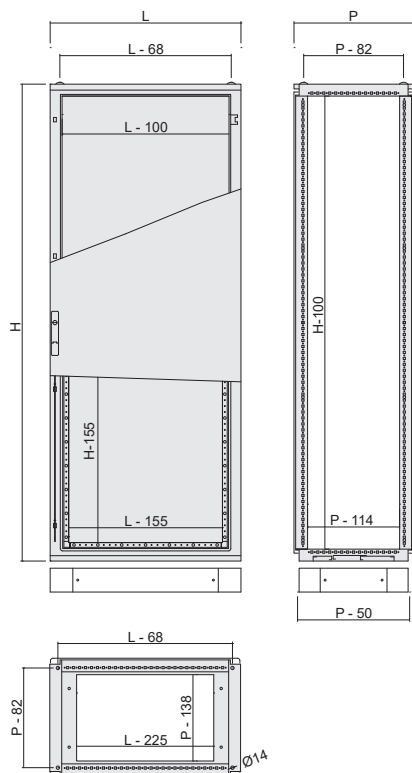

■ Armadio monoblocco saldato CAE per quadro elettrico per applicazioni indoor CAE welded enclosure

Armadio monoblocco CAE - Struttura con retro e porta trasparente CAE Compact Cabinet - Structure with rear and glass door



H 1600

CODICE CODE	LARGHEZZA (mm) WIDTH (mm)	DIMENSIONI, MM DIMENSIONS, MM
		PROFONDITÀ (mm) DEPTH (mm)
R5CAE1663X	600	300
R5CAE1664X		400
R5CAE1683X	800	300
R5CAE1684X		400
R5CAE16103X	1000	300
R5CAE16104X		400

H 1800

CODICE CODE	LARGHEZZA (mm) WIDTH (mm)	DIMENSIONI, MM DIMENSIONS, MM
		PROFONDITÀ (mm) DEPTH (mm)
R5CAE1863X	600	300
R5CAE1864X		400
R5CAE1865X		500
R5CAE1866X		600
R5CAE1883X	800	300
R5CAE1884X		400
R5CAE1885X		500
R5CAE1886X		600
R5CAE18104X	1000	400
R5CAE18105X		500
R5CAE18106X		600

H 2000

CODICE CODE	LARGHEZZA (mm) WIDTH (mm)	DIMENSIONI, MM DIMENSIONS, MM
		PROFONDITÀ (mm) DEPTH (mm)
R5CAE2063X	600	300
R5CAE2064X		400
R5CAE2065X		500
R5CAE2066X		600
R5CAE2083X	800	300
R5CAE2084X		400
R5CAE2085X		500
R5CAE2086X		600
R5CAE20104X	1000	400
R5CAE20105X		500
R5CAE20106X		600

■ Armadio monoblocco saldato CAE per quadro elettrico per applicazioni indoor CAE welded enclosure

Armadio monoblocco CAE - Struttura con retro e doppia porta trasparente CAE Compact Cabinet - Structure with rear and glass double door



IP55

Struttura

Chiusa lateralmente e superiormente in lamiera d'acciaio sp. 15/10 verniciata RAL7035 epossipoliestere bucciato e fondo con ingresso cavi regolabile.

Retro

Lamiera d'acciaio sp. 15/10 verniciato RAL7035 bucciato. Da 4 a 10 punti di fissaggio al telaio.

Porta

Lamiera d'acciaio sp. 20/10 verniciata RAL 7035 bucciato. 4 punti di chiusura, 4 cerniere e mostrina con inserto di chiusura tipo aletta doppio pettine Ø3 mm. Vetro di sicurezza sp. 40/10.

Grado di resistenza all'urto secondo IEC EN 62208: IK09

Structure

Assembled structure with a closed profile in 15/10 thick galvanized steel painted with RAL 7035, textured finish.

Rear

Made of 15/10 thick steel, painted with RAL7011, textured finish. From 4 to 10 points of fastening to the structure.

Door

20/10 thick steel, painted with textured RAL 7035. Complete with an internal reinforcement frame made of galvanized tubular profile, 4 closing points, 4 hinges and an escutcheon with Ø3 mm double-bit lock insert. 40/10 thick safety glass.

Impact resistance degree as per IEC EN 62208: IK09

H 1800

CODICE CODE	DIMENSIONI, MM DIMENSIONS, MM	
	LARGHEZZA (mm) WIDTH (mm)	PROFONDITÀ (mm) DEPTH (mm)
R5CAE18124X	1200	400
R5CAE18125X		500
R5CAE18126X		600

H 2000

CODICE CODE	DIMENSIONI, MM DIMENSIONS, MM	
	LARGHEZZA (mm) WIDTH (mm)	PROFONDITÀ (mm) DEPTH (mm)
R5CAE20124X	1200	400
R5CAE20125X		500
R5CAE20126X		600

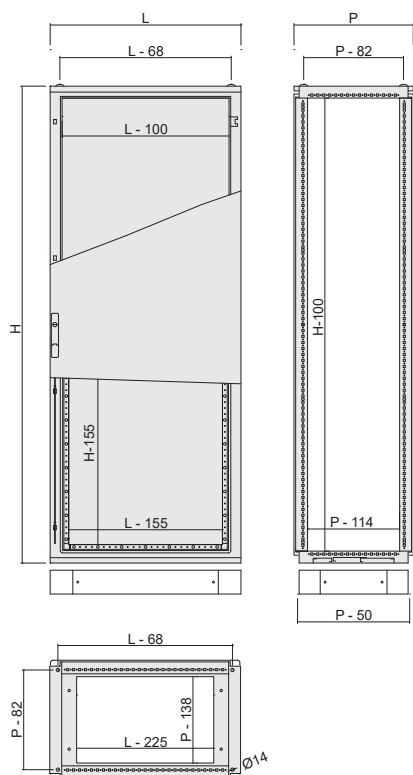

■ Armadio monoblocco saldato CAE per quadro elettrico per applicazioni indoor CAE welded enclosure

Armadio monoblocco CAE - Struttura con retro e porta in vetro serigrafato CAE Compact Cabinet - Structure with rear and screen-printed glass door



IP55

Struttura

Chiusa lateralmente e superiormente in lamiera d'acciaio sp. 15/10 verniciata RAL7035 epossipoliestere bucciato e fondo con ingresso cavi regolabile.

Retro

Lamiera d'acciaio sp. 15/10 verniciato RAL7035 bucciato con 8 punti di fissaggio al telaio.

Porta

Lamiera d'acciaio sp. 20/10 verniciata RAL 7035 bucciato. 4 punti di chiusura, 4 cerniere e mostrina con inserto di chiusura tipo aletta doppio pettine Ø3 mm. Vetro di sicurezza serigrafato fumè sp. 40/10.

Grado di resistenza all'urto secondo IEC EN 62208: IK09

Structure

Solid sides and top, made of 15/10 steel, painted RAL 7035 with textured epoxy polyester, adjustable cable gland bottom.

Rear panel

15/10 thick steel, painted textured RAL7035 with 8 points of fastening to the structure.

Door

20/10 thick steel, painted textured RAL 7035. Complete with an internal reinforcement frame made of galvanized tubular profile, 4 closing points, 4 hinges and an escutcheon with Ø3 mm doublebit lock insert. 40/10 thick safety screenprinted smoked glass.

Impact resistance degree as per IEC EN 62208: IK09

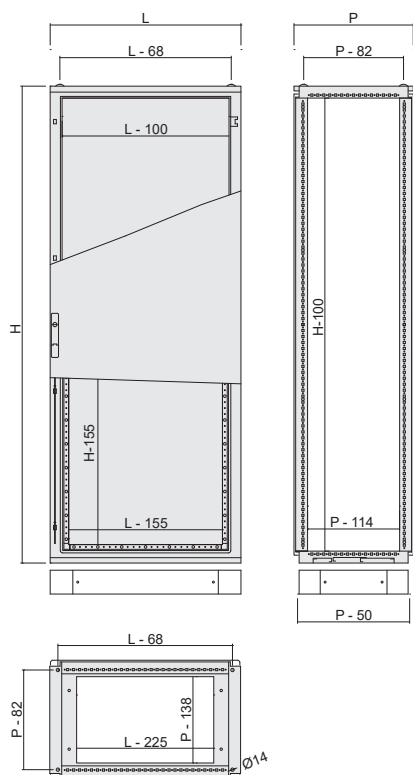

H 1600

CODICE CODE	DIMENSIONI, MM DIMENSIONS, MM	
	LARGHEZZA (mm) WIDTH (mm)	PROFONDITÀ (mm) DEPTH (mm)
R5CAE1663V	600	300
R5CAE1664V	600	400
R5CAE1683V	800	300
R5CAE1684V	800	400

H 1800

CODICE CODE	DIMENSIONI, MM DIMENSIONS, MM	
	LARGHEZZA (mm) WIDTH (mm)	PROFONDITÀ (mm) DEPTH (mm)
R5CAE1863V	600	300
R5CAE1864V	600	400
R5CAE1865V	600	500
R5CAE1866V	600	600
R5CAE1883V	800	300
R5CAE1884V	800	400
R5CAE1885V	800	500
R5CAE1886V	800	600

H 2000

CODICE CODE	DIMENSIONI, MM DIMENSIONS, MM	
	LARGHEZZA (mm) WIDTH (mm)	PROFONDITÀ (mm) DEPTH (mm)
R5CAE2063V	600	300
R5CAE2064V	600	400
R5CAE2065V	600	500
R5CAE2066V	600	600
R5CAE2083V	800	300
R5CAE2084V	800	400

■ Armadio monoblocco saldato CAE per quadro elettrico per applicazioni indoor CAE welded enclosure

Armadio monoblocco CAE - Struttura con retro e porta in vetro serigrafato
CAE Compact Cabinet - Structure with rear and screen-printed glass door



H 2000

CODICE CODE	DIMENSIONI, MM DIMENSIONS, MM	
	LARGHEZZA (mm) WIDTH (mm)	PROFONDITÀ (mm) DEPTH (mm)
R5CAE2085V	800	500
R5CAE2086V		600

■ Armadio monoblocco saldato CAE per quadro elettrico per applicazioni indoor CAE welded enclosure

Armadio monoblocco CAE orizzontale Struttura CAE Compact Horizontal Cabinet Structure



IP55

Struttura

chiusa lateralmente e superiormente in lamiera d'acciaio sp. 15/10 verniciata RAL 7035 epossipoliestere bucciato e fondo con ingresso cavi regolabile.

Retro

lamiera d'acciaio sp. 15/10 verniciato RAL 7035 bucciato con 6 - 8 punti di fissaggio al telaio.

Porta a doppia anta

lamiera d'acciaio sp. 20/10 verniciata RAL 7035 bucciato. Telaio interno di rinforzo in tubolare zincato. 4 punti di chiusura, 4 cerniere e mostrina con inserto di chiusura tipo aletta doppio pettine Ø 3 mm.

Grado di resistenza all'urto secondo IEC EN 62208: IK10

Grado di protezione

IP55 EN 60529 UL NEMA 12 (riferito all'armadio completo di porte).

N.B. Disponibili in 7 giorni lavorativi.

Structure

Solid sides and top, manufactured of 15/10 steel, painted RAL 7035 with textured epoxy-polyester, adjustable cable gland bottom.

Rear panel

15/10 thick steel, painted textured RAL 7035, 15/10 thick steel with 6 - 8 points of fastening to the structure.

Double door

20/10 thick steel, painted textured RAL 7035. Complete with an internal reinforcement frame made of galvanized tubular profile, 4 closing points, 4 hinges and an escutcheon with a double-bit lock insert Ø3 mm.

Impact resistance degree as per IEC EN 62208: IK10

Protection degree

IP55 EN 60529 UL NEMA type 12 (referred to enclosures complete with doors).

N.B. Available in 7 working days.

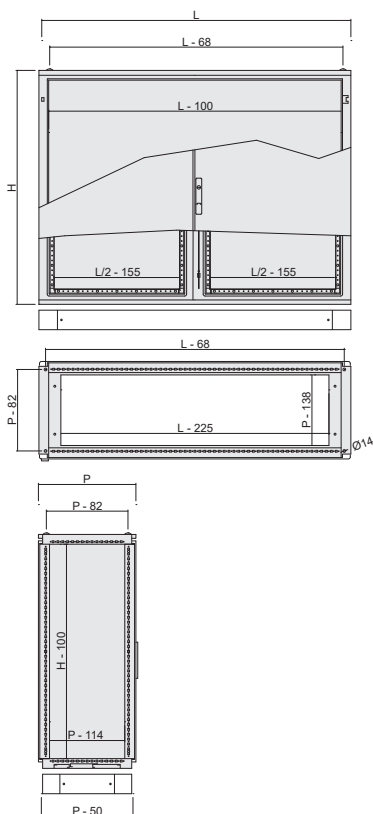

H 800

CODICE CODE	LARGHEZZA (mm) WIDTH (mm)	DIMENSIONI, MM DIMENSIONS, MM	
		PROFONDITÀ (mm) DEPTH (mm)	
R5CAE8124S	1200		
R5CAE8144S	1400		
R5CAE8164S	1600	400	
R5CAE8184S	1800		
R5CAE8204S	2000		

H 1000

CODICE CODE	LARGHEZZA (mm) WIDTH (mm)	DIMENSIONI, MM DIMENSIONS, MM	
		PROFONDITÀ (mm) DEPTH (mm)	
R5CAE10124S	1200		
R5CAE10144S	1400		
R5CAE10164S	1600	400	
R5CAE10184S	1800		
R5CAE10204S	2000		

■ Armadio monoblocco saldato CAE per quadro elettrico per applicazioni indoor CAE welded enclosure

Armadio monoblocco CAE orizzontale Struttura e retro CAE Compact Horizontal Cabinet Structure and rear panel



IP55

Struttura

chiusa lateralmente e superiormente in lamiera d'acciaio sp. 15/10 verniciata RAL 7035 epossipoliestere bucciato e fondo con ingresso cavi regolabile.

Retro

lamiera d'acciaio sp. 15/10 verniciato RAL 7035 bucciato con 6 - 8 punti di fissaggio al telaio.

Porta a doppia anta

lamiera d'acciaio sp. 20/10 verniciata RAL 7035 bucciato. Telaio interno di rinforzo in tubolare zincato. 4 punti di chiusura, 4 cerniere e mostrina con inserto di chiusura tipo aletta doppio pettine Ø 3 mm.

Grado di resistenza all'urto secondo IEC EN 62208: IK10

Grado di protezione

IP55 EN 60529 UL NEMA 12 (riferito all'armadio completo di porte).

N.B. Disponibili in 7 giorni lavorativi.

Structure

Solid sides and top, manufactured of 15/10 steel, painted RAL 7035 with textured epoxy-polyester, adjustable cable gland bottom.

Rear panel

15/10 thick steel, painted textured RAL 7035, 15/10 thick steel with 6 - 8 points of fastening to the structure.

Double door

20/10 thick steel, painted textured RAL 7035. Complete with an internal reinforcement frame made of galvanized tubular profile, 4 closing points, 4 hinges and an escutcheon with a double-bit lock insert Ø3 mm.

Impact resistance degree as per IEC EN 62208: IK10

Protection degree

IP55 EN 60529 UL NEMA type 12 (referred to enclosures complete with doors).

N.B. Available in 7 working days.

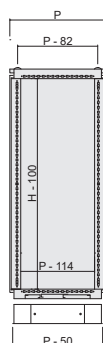
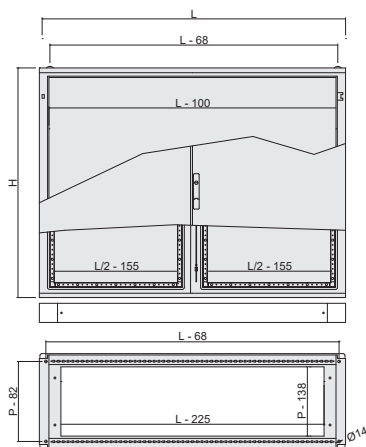

H 800

CODICE CODE	LARGHEZZA (mm) WIDTH (mm)	DIMENSIONI, MM DIMENSIONS, MM	
		PROFONDITÀ (mm) DEPTH (mm)	
R5CAE8124R	1200		
R5CAE8144R	1400		
R5CAE8164R	1600	400	
R5CAE8184R	1800		
R5CAE8204R	2000		

H 1000

CODICE CODE	LARGHEZZA (mm) WIDTH (mm)	DIMENSIONI, MM DIMENSIONS, MM	
		PROFONDITÀ (mm) DEPTH (mm)	
R5CAE10124R	1200		
R5CAE10144R	1400		
R5CAE10164R	1600	400	
R5CAE10184R	1800		
R5CAE10204R	2000		

■ Armadio monoblocco saldato CAE per quadro elettrico per applicazioni indoor CAE welded enclosure

Armadio monoblocco CAE orizzontale Struttura retro e porta cieca CAE Compact Horizontal Cabinet Structure rear panel and blank door



IP55

Struttura

Chiusa lateralmente e superiormente in lamiera d'acciaio sp. 15/10 verniciata RAL 7035 epossipoliestere bucciato e fondo con ingresso cavi regolabile.

Retro

Lamiera d'acciaio sp. 15/10 verniciato RAL 7035 bucciato con 6 - 8 punti di fissaggio al telaio.

Porta a doppia anta

Lamiera d'acciaio sp. 20/10 verniciata RAL 7035 bucciato. Telaio interno di rinforzo in tubolare zincato. 2 punti di chiusura, 2 cerniere e mostrina con inserto di chiusura tipo aletta doppio pettine Ø 3 mm.

Grado di resistenza all'urto secondo IEC EN 62208: IK10

Grado di protezione

IP55 EN 60529 UL NEMA 12 (riferito all'armadio completo di porte).

N.B. Disponibili in 7 giorni lavorativi.

Structure

Solid sides and top, manufactured of 15/10 steel, painted RAL 7035 with textured epoxy-polyester, adjustable cable gland bottom.

Rear panel

15/10 thick steel, painted textured RAL 7035, 15/10 thick steel with 6 - 8 points of fastening to the structure.

Double door

20/10 thick steel, painted textured RAL 7035. Complete with an internal reinforcement frame made of galvanized tubular profile, 2 closing points, 2 hinges and an escutcheon with a double-bit lock insert Ø3 mm.

Impact resistance degree as per IEC EN 62208: IK10

Protection degree

IP55 EN 60529 UL NEMA type 12 (referred to enclosures complete with doors).

N.B. Available in 7 working days.

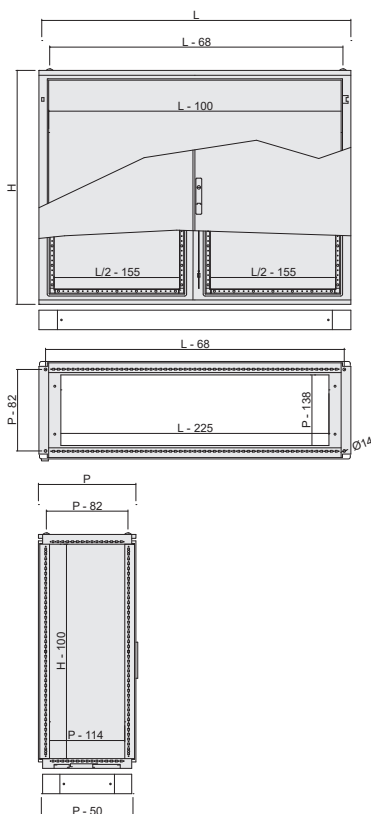

H 800

CODICE CODE	LARGHEZZA (mm) WIDTH (mm)	DIMENSIONI, MM DIMENSIONS, MM	
		PROFONDITÀ (mm) DEPTH (mm)	
R5CAE8124	1200		
R5CAE8144	1400		
R5CAE8164	1600	400	
R5CAE8184	1800		
R5CAE8204	2000		

H 1000

CODICE CODE	LARGHEZZA (mm) WIDTH (mm)	DIMENSIONI, MM DIMENSIONS, MM	
		PROFONDITÀ (mm) DEPTH (mm)	
R5CAE10124	1200		
R5CAE10144	1400		
R5CAE10164	1600	400	
R5CAE10184	1800		
R5CAE10204	2000		

■ Armadio monoblocco saldato CAE per quadro elettrico per applicazioni indoor CAE welded enclosure

Porta cieca a doppia anta per armadio CAE orizzontale Double Blank door for CAE horizontal cabinet



- In lamiera d'acciaio sp. 20/10 verniciata RAL 7035 bucciato.
 - Telaio interno di rinforzo in tubolare zincato.
 - 2 punti di chiusura, 2 cerniere e mostrina con inserto di chiusura tipo aletta doppio pettine Ø 3 mm.
 - Carico massimo: 50kg per ogni anta.
- Made of 20/10 thick steel, painted textured RAL 7035.
 - Complete with an internal reinforcement frame made of galvanized tubular profile.
 - 2 closing points, 2 hinges and an escutcheon with Ø3 mm double-bit lock insert.
 - Maximum load: 50kg for each door.

H 800

CODICE CODE	DIMENSIONI, MM DIMENSIONS, MM LARGHEZZA (mm) WIDTH (mm)
R5CPE8120	1200
R5CPE8140	1400
R5CPE8160	1600
R5CPE8180	1800
R5CPE8200	2000

H 1000

CODICE CODE	DIMENSIONI, MM DIMENSIONS, MM LARGHEZZA (mm) WIDTH (mm)
R5CPE10120	1200
R5CPE10140	1400
R5CPE10160	1600
R5CPE10180	1800
R5CPE10200	2000

■ Armadio monoblocco saldato CAE per quadro elettrico per applicazioni indoor CAE welded enclosure

Pannello di cablaggio per armadio CAE orizzontale Mounting panel for CAE horizontal cabinet

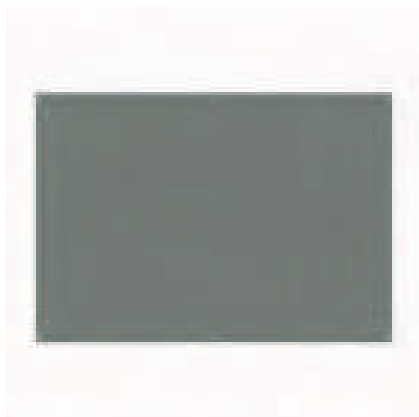

- Realizzato in lamiera d'acciaio zincata sendzimir sp. 25/10 oppure 30/10 (in relazione alla dimensione).
- Distanza massima tra la porta e il pannello di cablaggio pari a P - 82. Ad esempio: per un armadio profondo 500mm la distanza massima tra porta e pannello di cablaggio è pari a 500 - 82 = 418.
- Possibilità di arretramento massimo a filo della struttura tramite kit opzionale art. RZAE06. Con questo accessorio la distanza massima tra porta e pannello di cablaggio è pari a P - 57.
- Confezione completa di accessori per il montaggio.
- Carico massimo 300 Kg/m² (max 500 Kg per la misura 1000x2000mm).

Attenzione: si consiglia l'uso di guanti appropriati durante la movimentazione dei pannelli di cablaggio (Artt. 41-42-43 DLG 626/94).

- Made of Sendzimir galvanized steel sheet with a thickness of 25/10 or 30/10 (depending on the dimensions).
 - Maximum distance between door and mounting panel is equal to P - 82. For example: if the depth of an enclosure is 500 mm, the maximum distance between door and mounting panel is equal to 500 - 82 = 418.
 - It is possible to mount the panel in the in the structure's farthest position against the structure by means of an optional kit code RZAE06. With this accessory the maximum distance between door and mounting panel is equal to P - 57.
 - The package includes mounting accessories.
 - Max. load 300 Kg/m² (max 500 Kg for the size 1000x2000mm).
- Caution: it is recommended to use appropriate gloves to handle mounting panels. (Artt. 41-42-43 DLG 626/94).**

H 800

CODICE CODE	LARGHEZZA (mm) WIDTH (mm)	DIMENSIONI, MM DIMENSIONS, MM	
		ALTEZZA ELEMENTO (mm) ELEMENT HEIGHT (mm)	LARGHEZZA ELEMENTO (mm) ELEMENT WIDTH (mm)
RZCPCE8120	1200	683	1086
RZCPCE8140	1400		1286
RZCPCE8160	1600		1486
RZCPCE8180	1800		1686
RZCPCE8200	2000		1886

H 1000

CODICE CODE	LARGHEZZA (mm) WIDTH (mm)	DIMENSIONI, MM DIMENSIONS, MM	
		ALTEZZA ELEMENTO (mm) ELEMENT HEIGHT (mm)	LARGHEZZA ELEMENTO (mm) ELEMENT WIDTH (mm)
RZCPCE10120	1200	883	1086
RZCPCE10140	1400		1286
RZCPCE10160	1600		1486
RZCPCE10180	1800		1686
RZCPCE10200	2000		1886

■ Armadio monoblocco saldato CAE per quadro elettrico per applicazioni indoor CAE welded enclosure

Retro per armadio CAE orizzontale Rear panel for horizontal CAE cabinet



- Realizzato in acciaio sp. 15/10 verniciato RAL 7035 bucciato.
- 8 o più punti di fissaggio alla struttura.

- Made of 15/10 thick steel sheet painted textured RAL 7035.
- 8 or more points for mounting to the structure.

H 800

CODICE CODE	DIMENSIONI, MM DIMENSIONS, MM LARGHEZZA (mm) WIDTH (mm)
R5CRE8121	1200
R5CRE8141	1400
R5CRE8161	1600
R5CRE8181	1800
R5CRE8201	2000

H 1000

CODICE CODE	DIMENSIONI, MM DIMENSIONS, MM LARGHEZZA (mm) WIDTH (mm)
R5CRE10121	1200
R5CRE10141	1400
R5CRE10161	1600
R5CRE10181	1800
R5CRE10201	2000

The logo consists of a stylized white square icon with a smaller square inside, positioned above the words "RAM" and "BLOCK" in a bold, white, sans-serif font, all set against a dark grey background.

**RAM
BLOCK**

Accessori
Accessories

■ Accessori

Accessories

Per armadi For enclosures

Molti accessori sono universali e pertanto adatti a tutte le serie di armadi DKC. Altri, dove segnalato, sono specifici solo per alcune serie.

Per scegliere l'accessorio corretto è necessario conoscere le dimensioni dell'armadio e consultare le rispettive tabelle. Tutti gli accessori per il montaggio sono inclusi nella confezione. Qui di seguito la lista delle principali famiglie di accessori per armadi DKC.

A lot of accessories are universal and suitable, therefore, for all DKC enclosure lines. Some other accessories, where indicated, are specific only for some of the product lines. In order to choose an appropriate accessory it is necessary to know the enclosure dimensions and refer to the relative tables.

All mounting accessories are included to the supply. The list here below illustrates the main families of accessories for DKC enclosures.

Telai rack e profili 19" 19" racks and profiles



Telai rack 19" in versione totale o parziale, laterali o centrati rispetto all'armadio; con apertura a 130° o in alternativa a 180°. Completano la gamma i profili 19" fissi a forma di "C" o di "L" (a seconda dell'applicazione) e relativi accessori 19".

19" racks, full or partial, side or central with respect to the enclosure; 130° opening or 180° opening as an option.

The range is completed by fixed 19" profiles, C-shaped or L-shaped (depending on the application type) and the relative 19" accessories.

Porte e chiusure Doors and locking elements

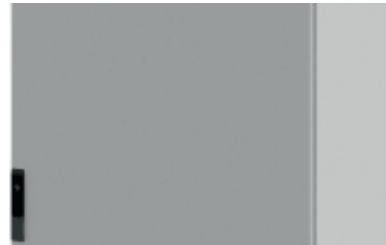

A singola o doppia anta, in versione lamiera cieca o con vetro di sicurezza trasparente oppure serigrafato dal design innovativo e ricercato esteticamente. Numerosi accessori a completamento.

Single or double door, blank or glazed, with transparent or screen-printed safety glass characterised by an innovative and refined design. The completion accessories are numerous.

Accessori unione armadi Enclosure baying accessories

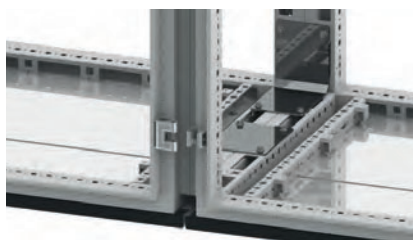

Piastre di compensazione per pannelli di cablaggio, kit unione meccanica armadi e kit rinforzo unione per "carichi pesanti". Possibilità di unione armadi retro/retro con apposito kit.

Compensation panel for mounting panels, mechanical baying kit and baying reinforcement kit for heavy duty. Back-to-back baying special kit.

Accessori sollevamento Lifting accessories



Golfari, squadrette di sollevamento, traverse presso-piegate o in acciaio laminato a caldo per garantire il sollevamento di batterie particolarmente "pesanti".

Lifting eye bolts, brackets, press-bended rails or hot laminated rails for particularly heavy bayed enclosures lifting.

■ Accessori Accessories

Per armadi For enclosures

Profili Rails

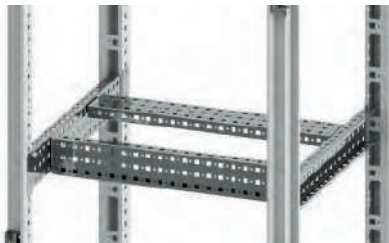

Profili in lamiera zincata sendzimir, installabili sul profilo portante dell'armadio. Consentono l'allestimento interno a passo regolabile (25 mm) e permettono di creare una struttura interna adattabile alle esigenze del cliente. Disponibili anche profili porta-trasformatore ed ancoraggio cavi.

Sendzimir galvanized rails, mountable to the support profile of a enclosure, allow the internal equipment arrangement with 25 mm adjustable pitch and permit to create an internal structure customized in conformity to the customer's requirements. Transformer support rails and cable tie-down rails are also available.

Ripiani Trays



Ripiano di lavoro (da applicare alle porte), ripiani fissi o estraibili da applicare direttamente al telaio dell'armadio.

Working tray (to be applied to the doors), fixed or sliding trays applicable directly to the enclosure frame.

Gestione cavi Cable management



Sopralzi cavi modulari, unici da ordinare al metro lineare, vano cavi o risalite cavi con relativi accessori a completamento.

Modular top compartments for cable management, the only supplied by the metre, cable compartments with side access or cable chambers and relative completion accessories.

Pannelli di cablaggio Mounting panels



Ad inserimento frontale, laterale, parziale o totale.

Front entry, side entry; partial or full.

Ingresso cavi Cable entry

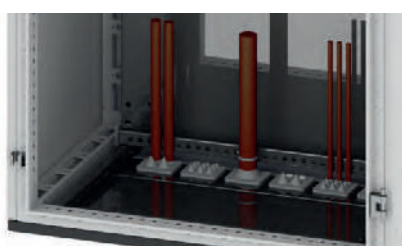

Fondo unico, profili e piastre passacavi per agevolare l'ingresso cavi dal fondo armadio, mantenendo un elevato grado di protezione IP.

Solid bottom, rails and cable gland plates allowing cable entry from the enclosure bottom, assuring a high IP protection degree.

Zoccoli Plinth

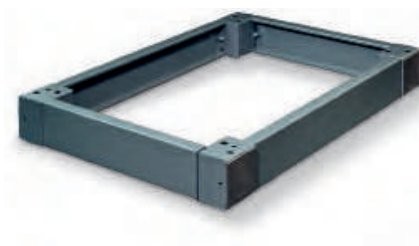

In versione modulare/componibile, unico rinforzato o a vasca, antivibrante. Numerosi accessori di regolazione a completamento.

Modular/assembled, reinforced solid or blind, earthquake resistant. Numerous adjustment accessories.

■ Accessori armadi

Enclosure accessories

Pannello di cablaggio a inserimento frontale per CQE e CAE

Front-entry mounting plate for CQE and CAE cabinets



- Realizzato in lamiera d'acciaio zincata sendzimir sp. 25/10 oppure 30/10 (in relazione alla dimensione).
- Distanza massima tra la porta e il pannello di cablaggio pari a P - 82. Ad esempio: per un armadio profondo 500mm la distanza massima tra porta e pannello di cablaggio è pari a 500 - 82 = 418.
- Possibilità di arretramento massimo a filo della struttura tramite kit opzionale art. RZAE06. Con questo accessorio la distanza massima tra porta e pannello di cablaggio è pari a P - 57.
- Confezione completa di accessori per il montaggio.
- Carico massimo 300 Kg/m2 (max 600 Kg).

Attenzione: si consiglia l'uso di guanti appropriati durante la movimentazione dei pannelli di cablaggio (DLG 81/08). Larghezze 1400 e 1600 fornite in due metà preassemblate.

- Made of Sendzimir galvanized steel 25/10 or 30/10 thick (depending on the dimensions).
- Max. distance between door and mounting panel is equal to P - 82. For example: if the depth of a enclosure is 500 mm, the max. Distance between door and mounting panel is equal to 500 - 82 = 418.
- It is possible to mount the panel in the structure's farthest position by means of an optional kit (code RZAE06). With this accessory the maximum distance between door and mounting panel is equal to P - 57.
- The package includes mounting accessories.
- Max. load: 300 Kg/m2 (max 600 Kg).

Caution: it is recommended to use appropriate gloves to handle mounting panels (DLG 81/08). 1400 and 1600 widths supplied in two pre-assembled halves.

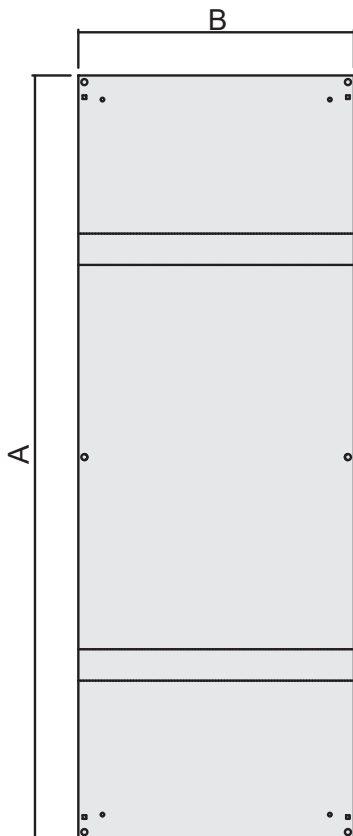

H 1000

CODICE CODE	LARGHEZZA (mm) WIDTH (mm)	DIMENSIONI, MM DIMENSIONS, MM	
		A A	B B
RZPCE1060	600		486
RZPCE1080	800	883	686
RZPCE10100	1000		886

H 1200

CODICE CODE	LARGHEZZA (mm) WIDTH (mm)	DIMENSIONI, MM DIMENSIONS, MM	
		A A	B B
RZPCE1240	400		286
RZPCE1260	600		486
RZPCE1280	800	1083	686
RZPCE12100	1000		886
RZPCE12120	1200		1086

H 1400

CODICE CODE	LARGHEZZA (mm) WIDTH (mm)	DIMENSIONI, MM DIMENSIONS, MM	
		A A	B B
RZPCE1460	600		486
RZPCE1480	800		686
RZPCE14100	1000	1283	886
RZPCE14120	1200		1086
RZPCE14160	1600		1486

■ Accessori armadi

Enclosure accessories

Pannello di cablaggio a inserimento frontale per CQE e CAE

Front-entry mounting plate for CQE and CAE cabinets



H 1600

CODICE CODE	LARGHEZZA (mm) WIDTH (mm)	DIMENSIONI, MM DIMENSIONS, MM	
		A A	B B
RZPCE1640	400	1483	286
RZPCE1660	600		486
RZPCE1680	800		686
RZPCE16100	1000		886
RZPCE16120	1200		1086

H 1800

CODICE CODE	LARGHEZZA (mm) WIDTH (mm)	DIMENSIONI, MM DIMENSIONS, MM	
		A A	B B
RZPCE1830	300	1683	186
RZPCE1840	400		286
RZPCE1860	600		486
RZPCE1880	800		686
RZPCE18100	1000		886
RZPCE18120	1200		1086

H 2000

CODICE CODE	LARGHEZZA (mm) WIDTH (mm)	DIMENSIONI, MM DIMENSIONS, MM	
		A A	B B
RZPCE2030	300	1883	186
RZPCE2040	400		286
RZPCE2060	600		486
RZPCE2080	800		686
RZPCE20100	1000		886
RZPCE20120	1200		1086
RZPCE20140	1400		1286
RZPCE20160	1600		1486

H 2200

CODICE CODE	LARGHEZZA (mm) WIDTH (mm)	DIMENSIONI, MM DIMENSIONS, MM	
		A A	B B
RZPCE2230	300	2083	186
RZPCE2240	400		286
RZPCE2260	600		486
RZPCE2280	800		686
RZPCE22100	1000		886
RZPCE22120	1200		1086

■ Accessori armadi

Enclosure accessories

Pannello di cablaggio parziale per CQE, CAE

Partial mounting plate for CQE and CAE cabinets



- Realizzato in lamiera d'acciaio zincata sendzimir sp. 25/10.
- Passo di fissaggio alla struttura pari a 25mm con possibilità di arretramento a filo montante.
- Confezione comprensiva di squadrette e viteria per il montaggio.
- Da ordinare separatamente: 1 confezione di profili laterali (art. RZPDL) corrispondenti alla profondità dell'armadio.
- In presenza di portine modulari, divisori orizzontali e/o traverse di battuta, ordinare 1 confezione di traverse laterali (art. RZTLE o RZPLE) corrispondenti alla profondità dell'armadio.
- Carico massimo 200 Kg/m2

- Made of Sendzimir galvanized steel th. 25/10.
- Fixing pitch to the structure equal to 25 mm with the possibility of mounting the panel in the farthest position, flush with the uprights.
- Package includes squares and mounting screws.
- 1 pack of side bars (art. RZPDL) corresponding to the enclosure depth is to be ordered separately.
- In case of modular doors, horizontal partition panels and/or slamming strips, 1 pack of side cross rails (code: RZTLE or RZPLE) corresponding to the enclosure depth is to be ordered separately.
- Max. load 200 Kg/m2

H 600

CODICE CODE	LARGHEZZA (mm) WIDTH (mm)	DIMENSIONI, MM DIMENSIONS, MM	
		ALTEZZA ELEMENTO (mm) ELEMENT HEIGHT (mm)	LARGHEZZA ELEMENTO (mm) ELEMENT WIDTH (mm)
RZPCPE66	600	595	486
RZPCPE68	800		686
RZPCPE610	1000		886

H 800

CODICE CODE	LARGHEZZA (mm) WIDTH (mm)	DIMENSIONI, MM DIMENSIONS, MM	
		ALTEZZA ELEMENTO (mm) ELEMENT HEIGHT (mm)	LARGHEZZA ELEMENTO (mm) ELEMENT WIDTH (mm)
RZPCPE86	600	795	486
RZPCPE88	800		686
RZPCPE810	1000		886

H 1000

CODICE CODE	LARGHEZZA (mm) WIDTH (mm)	DIMENSIONI, MM DIMENSIONS, MM	
		ALTEZZA ELEMENTO (mm) ELEMENT HEIGHT (mm)	LARGHEZZA ELEMENTO (mm) ELEMENT WIDTH (mm)
RZPCPE106	600	995	486
RZPCPE108	800		686
RZPCPE1010	1000		886

H 1200

CODICE CODE	LARGHEZZA (mm) WIDTH (mm)	DIMENSIONI, MM DIMENSIONS, MM	
		ALTEZZA ELEMENTO (mm) ELEMENT HEIGHT (mm)	LARGHEZZA ELEMENTO (mm) ELEMENT WIDTH (mm)
RZPCPE126	600	1195	486
RZPCPE128	800		686
RZPCPE1210	1000		886

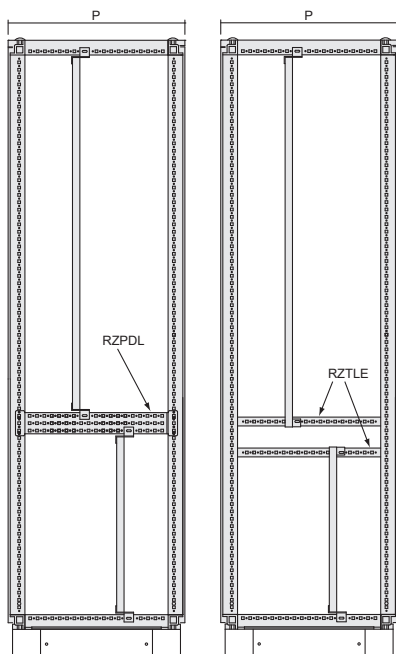

■ Accessori armadi

Enclosure accessories

Kit squadrette di sostegno pannello di cablaggio parziale

Kit of support cleat angles for partial mounting panels



- Realizzate in lamiera d'acciaio zincata sendzimir.
- Possibilità di montaggio sia alla sommità del pannello di cablaggio che nel centro tramite i fori già presenti sulla piastra.
- Nel caso di montaggio in zona centrale è necessario acquistare separatamente i traversini laterali (art. RZTLE).
- Made of Sendzimir galvanized steel.
- May be fixed both at the top or in the centre of a panel through holes provided on the panels.
- In case of mounting in the central part, side cross rails (code: RZTLE) are to be ordered separately.

CODICE
CODE

RZAE05

■ Accessori armadi

Enclosure accessories

Pannello di cablaggio a inserimento laterale per CQE

Side-entry mounting plate for CQE cabinets



- Realizzato in lamiera d'acciaio zincata sendzimir sp. 25/10 oppure 30/10 per larghezze 1200 e 1400.
- Passo di fissaggio alla struttura pari a 25mm.
- Guide di fissaggio incluse nella fornitura.
- Distanza massima pannello di cablaggio porta pari a P - 105. Esempio per R5CQE2086: P=600 mm. Distanza max = 600 - 105 = 495 mm. • Carico massimo 300 Kg/m2 (max 600 Kg).
- Pannello scorrevole di larghezza 1600mm fornito in due parti separate da assemblare.

Larghezza 1600 fornita in due metà da unire in opera.

- Made of Sendzimir galvanized steel sheet with a thickness of 25/10 or 30/10 (depending on the dimensions).
 - Mounting pitch to the structure equal to 25mm.
 - Mounting guide included in the package.
 - Max. distance between door and mounting panel is equal to P - 105. For example, in case of R5CQE2086 P = 600mm. Max. distance = 600 - 105 = 495mm.
 - Max. load: 300 Kg/m2 (max 600 Kg).
 - 1400 and 1600 mm wide sliding panel supplied in two separate parts to be assembled.
- 1600 width supplied in two halves to be joined on site.**

H 1600

CODICE CODE	LARGHEZZA (mm) WIDTH (mm)	DIMENSIONI, MM DIMENSIONS, MM	
		A A	B B
RZPCSE1660	600	1485	600
RZPCSE1680	800		800
RZPCSE16100	1000		1000
RZPCSE16120	1200		1200

H 1800

CODICE CODE	LARGHEZZA (mm) WIDTH (mm)	DIMENSIONI, MM DIMENSIONS, MM	
		A A	B B
RZPCSE1860	600	1685	600
RZPCSE1880	800		800
RZPCSE18100	1000		1000
RZPCSE18120	1200		1200

H 2000

CODICE CODE	LARGHEZZA (mm) WIDTH (mm)	DIMENSIONI, MM DIMENSIONS, MM	
		A A	B B
RZPCSE2060	600	1885	600
RZPCSE2080	800		800
RZPCSE20100	1000		1000
RZPCSE20120	1200		1200
RZPCSE20140	1400		1400
RZPCSE20160	1600		1600

H 2200

CODICE CODE	LARGHEZZA (mm) WIDTH (mm)	DIMENSIONI, MM DIMENSIONS, MM	
		A A	B B
RZPCSE2260	600	2085	600
RZPCSE2280	800		800
RZPCSE22100	1000		1000
RZPCSE22120	1200		1200

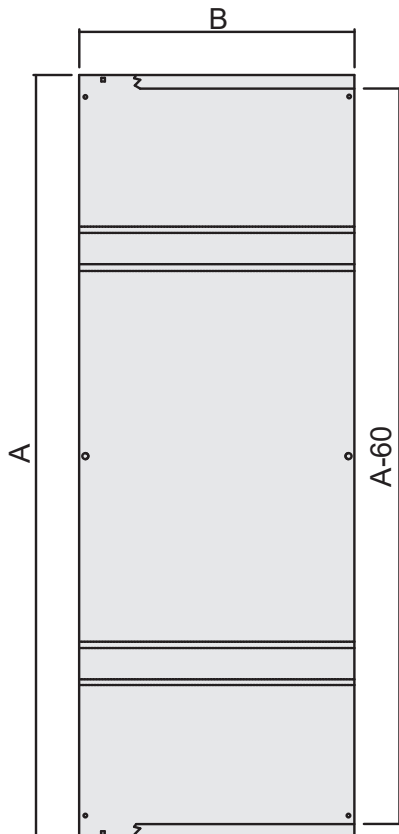

■ Accessori armadi

Enclosure accessories

Rinforzi trasversali per pannello di cablaggio a inserimento frontale

Reinforcement cross rails for front entry mounting plate

- Utili per il fissaggio di componenti particolarmente pesanti.
- La fornitura comprende due rinforzi e viteria necessaria al montaggio.
- Suitable for securing particularly heavy components.
- The supply contains two reinforcement rails and fasteners necessary for installation



CODICE CODE	DIMENSIONI, MM DIMENSIONS, MM LARGHEZZA (mm) WIDTH (mm)
RZRPC60	600
RZRPC80	800
RZRPC100	1000
RZRPC120	1200
RZRPC140	1400
RZRPC160	1600

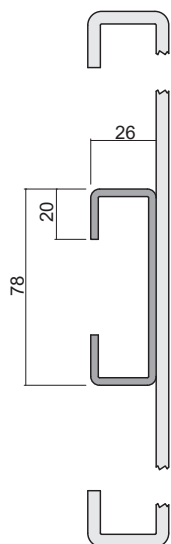

■ Accessori armadi

Enclosure accessories

Rinforzi trasversali per pannello di cablaggio a inserimento laterale

Reinforcement cross rails for front entry mounting plate

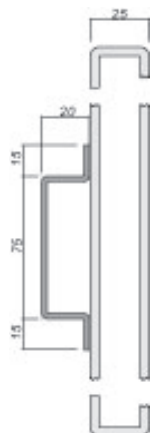

- Realizzati in lamiera zincata sendzimir spessore 20/10.
- Utili per il fissaggio di componenti particolarmente pesanti.
- Al momento dell'ordine precisarne la lunghezza.
- Articolo venduto al metro lineare.
- Confezione da 2 pezzi completa di accessori per il montaggio.

- Made of 20/10 thick Sendzimir galvanized steel.
- Suitable for securing particularly heavy components.
- The required length is to be specified at the order.
- Sold by the linear meter.
- Pack of 2 pieces complete with mounting accessories.

CODICE CODE	DIMENSIONI, MM DIMENSIONS, MM CONFEZIONI/PZ PACK/PCS
RZRPCSE30	2

■ Accessori armadi

Enclosure accessories

Piastra supplementare per pannello di cablaggio a inserimento frontale

Additional panel plate for front-entry mounting plate

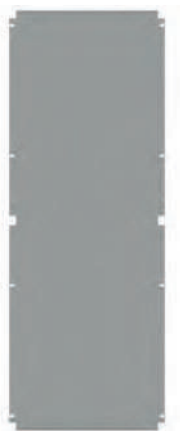

- Realizzata in lamiera d'acciaio zincata sendzimir sp. 25/10.
- Viene avvitata direttamente nella parte posteriore del pannello di cablaggio per consentire il fissaggio dei componenti sia sul fronte che sul retro del medesimo, riducendo al minimo gli ingombri.
- Completa di viteria per il montaggio.

- Made of 25/10 thick Sendzimir galvanized steel.
- To be screwed directly to the rear side of a mounting panel to allow components installation both at the front and at the back of it, reducing the dimensions to a minimum.
- Complete with mounting screws.

H 1800

CODICE CODE	LARGHEZZA (mm) WIDTH (mm)	DIMENSIONI, MM DIMENSIONS, MM	
		A A	B B
RZPSP1860	600	1650	480
RZPSP1880	800		680
RZPSP18100	1000		880
RZPSP18120	1200		1080

H 2000

CODICE CODE	LARGHEZZA (mm) WIDTH (mm)	DIMENSIONI, MM DIMENSIONS, MM	
		A A	B B
RZPSP2060	600	1850	480
RZPSP2080	800		680
RZPSP20100	1000		880
RZPSP20120	1200		1080

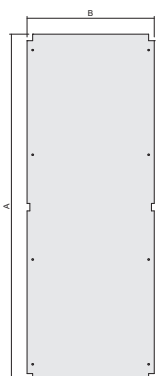

■ Accessori armadi

Enclosure accessories

Kit arretramento pannello di cablaggio a inserimento frontale

Inward installation kit for front entry mounting panels



- Realizzato in lamiera d'acciaio zincata sendzimir.
- Permette di arretrare il pannello di cablaggio portandolo a filo montanti.
- Confezione 2 pezzi completa di viteria per il montaggio.
- Da posizionare nella parte inferiore dell'armadio in sostituzione dei supporti per il pannello di cablaggio standard già esistenti.
- Distanza massima tra la porta e il pannello di cablaggio pari a P - 57. Ad esempio: per un armadio profondo 600 mm la distanza massima tra porta e pannello di cablaggio è pari a 600 - 57=543 mm.

- Made of Sendzimir galvanized steel.
- Allows the inward panel installation placing it in the farthest position flush with the uprights.
- Pack of 2 pieces complete with screws for assembly.
- To be mounted in the lower part of the enclosure in substitution of the standard supports provided with the panel.
- Max. distance between door and mounting panel is equal to P - 57. For example, in case of an enclosure with the depth of 600 mm, the maximum distance between door and mounting panel is 600 - 57 = 543 mm.

CODICE CODE	DIMENSIONI, MM DIMENSIONS, MM CONFEZIONI/PZ PACK/PCS
RZAE06	2

Kit unione piastre ad inserimento laterale

Joining kits for side entry mounting plate

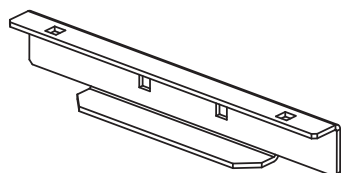

- Realizzato in lamiera d'acciaio zincata sendzimir.
- Permette di unire due pannelli di cablaggio a inserimento laterale.
- Confezione 2 pezzi completa di viteria per il montaggio.

- Made of Sendzimir galvanized steel.
- Allows joining the two mounting panels to side entry.
- Pack of 2 pieces complete with mounting accessories.

CODICE CODE	DIMENSIONI, MM DIMENSIONS, MM PESO NETTO (kg) NET WEIGHT (kg)
RZKUPCSE	0,5

■ Accessori armadi

Enclosure accessories

Kit montaggio pannello di cablaggio a inserimento frontale

Mounting kit for front entry mounting panels



- Accessori per il montaggio dei pannelli di cablaggio (RZPCE).
- Accessori già compresi nella fornitura del pannello di cablaggio.
- E' possibile ordinarlo separatamente.

- Accessories for mounting panels (RZPCE) installation.
- This accessory is included with mounting panels.
- This accessory may be ordered separately.

CODICE CODE	DIMENSIONI, MM DIMENSIONS, MM CONFEZIONI/PZ PACK/PCS
RAAE07	1

■ Accessori armadi Enclosure accessories

Zoccolo unico in lamiera pressopiegata per CQE Solid plinth of press-formed steel for CQE



- Realizzato in lamiera d'acciaio sp. 30/10 pressopiegata e profilata a "C", verniciato RAL 7011 liscio.
- Completo di flange di chiusura laterali (solo su altezza 200) e viteria di montaggio.
- Al momento dell'ordine precisarne la lunghezza.
- Articolo venduto al metro lineare.
- Non può essere applicato sugli armadi della serie CAE.
- In presenza di risalita cavi con accesso frontale larghezza 300 mm, in fase d'ordine fornire la configurazione della batteria di armadi per la foratura.

- Made of 30/10 thick press-formed steel sheet, C-profiled, painted smooth RAL 7011.
- Complete with side blanking plates (only for 200 height) and fasteners.
- The required length is to be specified at the order.
- Sold by the linear meter.
- Not applicable to CAE and DAE enclosures.
- In case of a 300 mm wide cable chamber with front access, the configuration of enclosure bayed system is to be provided with the order for appropriate plinth drilling.

H 100

CODICE CODE	LARGHEZZA (mm) WIDTH (mm)	DIMENSIONI, MM DIMENSIONS, MM	
		PROFONDITÀ (mm) DEPTH (mm)	B B
R1ZUE41-080	800	400	350
R1ZUE51-080		500	450
R1ZUE61-080		600	550
R1ZUE81-080		800	750
R1ZUE41-100	1000	400	350
R1ZUE51-100		500	450
R1ZUE61-100		600	550
R1ZUE81-100		800	750
R1ZUE41-120	1200	400	350
R1ZUE51-120		500	450
R1ZUE61-120		600	550
R1ZUE81-120		800	750
R1ZUE41-140	1400	400	350
R1ZUE51-140		500	450
R1ZUE61-140		600	550
R1ZUE81-140		800	750
R1ZUE41-160	1600	400	350
R1ZUE51-160		500	450
R1ZUE61-160		600	550
R1ZUE81-160		800	750
R1ZUE41-180	1800	400	350
R1ZUE51-180		500	450
R1ZUE61-180		600	550
R1ZUE81-180		800	750
R1ZUE41-200	2000	400	350
R1ZUE51-200		500	450
R1ZUE61-200		600	550
R1ZUE81-200		800	750
R1ZUE41-220	2200	400	350
R1ZUE51-220		500	450
R1ZUE61-220		600	550

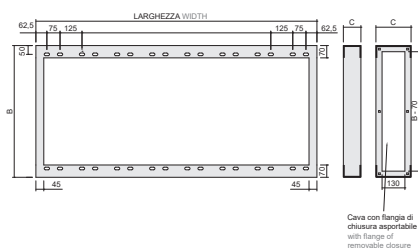

■ Accessori armadi

Enclosure accessories

Zoccolo unico in lamiera pressopiegata per CQE
Solid plinth of press-formed steel for CQE



H 100

CODICE CODE	LARGHEZZA (mm) WIDTH (mm)	DIMENSIONI, MM DIMENSIONS, MM	
		PROFONDITÀ (mm) DEPTH (mm)	B B
R1ZUE81-220	2200	800	750
R1ZUE41-240		400	350
R1ZUE51-240		500	450
R1ZUE61-240		600	550
R1ZUE81-240		800	750
R1ZUE41-260		400	350
R1ZUE51-260		500	450
R1ZUE61-260	2600	600	550
R1ZUE81-260		800	750
R1ZUE41-280		400	350
R1ZUE51-280		500	450
R1ZUE61-280	2800	600	550
R1ZUE81-280		800	750
R1ZUE41-300		400	350
R1ZUE51-300		500	450
R1ZUE61-300	3000	600	550
R1ZUE81-300		800	750
R1ZUE41-320		400	350
R1ZUE51-320		500	450
R1ZUE61-320	3200	600	550
R1ZUE81-320		800	750
R1ZUE41-340		400	350
R1ZUE51-340		500	450
R1ZUE61-340	3400	600	550
R1ZUE81-340		800	750
R1ZUE41-360		400	350
R1ZUE51-360		500	450
R1ZUE61-360	3600	600	550
R1ZUE81-360		800	750
R1ZUE41-380		400	350
R1ZUE51-380		500	450
R1ZUE61-380	3800	600	550
R1ZUE81-380		800	750
R1ZUE41-400		400	350
R1ZUE51-400		500	450
R1ZUE61-400	4000	600	550
R1ZUE81-400		800	750
R1ZUE41-420		400	350
R1ZUE51-420		500	450
R1ZUE61-420	4200	600	550
R1ZUE81-420		800	750
R1ZUE41-440		400	350
R1ZUE51-440		500	450
R1ZUE61-440	4400	600	550
R1ZUE81-440		800	750
R1ZUE41-460		400	350
R1ZUE51-460		500	450
R1ZUE61-460	4600	600	550

■ Accessori armadi

Enclosure accessories

Zoccolo unico in lamiera pressopiegata per CQE

Solid plinth of press-formed steel for CQE



H 100

CODICE CODE	LARGHEZZA (mm) WIDTH (mm)	DIMENSIONI, MM DIMENSIONS, MM	
		PROFONDITÀ (mm) DEPTH (mm)	B B
R1ZUE81-460	4600	800	750
R1ZUE41-480		400	350
R1ZUE51-480		500	450
R1ZUE61-480	4800	600	550
R1ZUE81-480		800	750
R1ZUE41-500		400	350
R1ZUE51-500		500	450
R1ZUE61-500	5000	600	550
R1ZUE81-500		800	750
R1ZUE41-520		400	350
R1ZUE51-520		500	450
R1ZUE61-520	5200	600	550
R1ZUE81-520		800	750
R1ZUE41-540		400	350
R1ZUE51-540		500	450
R1ZUE61-540	5400	600	550
R1ZUE81-540		800	750
R1ZUE41-560		400	350
R1ZUE51-560		500	450
R1ZUE61-560	5600	600	550
R1ZUE81-560		800	750
R1ZUE41-580		400	350
R1ZUE51-580		500	450
R1ZUE61-580	5800	600	550
R1ZUE81-580		800	750
R1ZUE41-600		400	350
R1ZUE51-600		500	450
R1ZUE61-600	6000	600	550
R1ZUE81-600		800	750
R1ZUE41-620		400	350
R1ZUE51-620		500	450
R1ZUE61-620	6200	600	550
R1ZUE81-620		800	750
R1ZUE41-640		400	350
R1ZUE51-640		500	450
R1ZUE61-640	6400	600	550
R1ZUE81-640		800	750
R1ZUE41-660		400	350
R1ZUE51-660		500	450
R1ZUE61-660	6600	600	550
R1ZUE81-660		800	750
R1ZUE41-680		400	350
R1ZUE51-680		500	450
R1ZUE61-680	6800	600	550
R1ZUE81-680		800	750
R1ZUE41-700		400	350
R1ZUE51-700	7000	500	450

■ Accessori armadi

Enclosure accessories

Zoccolo unico in lamiera pressopiegata per CQE

Solid plinth of press-formed steel for CQE



H 100

CODICE CODE	LARGHEZZA (mm) WIDTH (mm)	DIMENSIONI, MM DIMENSIONS, MM	
		PROFONDITÀ (mm) DEPTH (mm)	B B
R1ZUE61-700	7000	600	550
R1ZUE81-700		800	750
R1ZUE41-720	7200	400	350
R1ZUE51-720		500	450
R1ZUE61-720		600	550
R1ZUE81-720		800	750
R1ZUE41-740	7400	400	350
R1ZUE51-740		500	450
R1ZUE61-740		600	550
R1ZUE81-740		800	750

H 200

CODICE CODE	LARGHEZZA (mm) WIDTH (mm)	DIMENSIONI, MM DIMENSIONS, MM	
		PROFONDITÀ (mm) DEPTH (mm)	B B
R1ZUE42-080	800	400	350
R1ZUE52-080		500	450
R1ZUE62-080		600	550
R1ZUE82-080		800	750
R1ZUE42-100	1000	400	350
R1ZUE52-100		500	450
R1ZUE62-100		600	550
R1ZUE82-100		800	750
R1ZUE42-120	1200	400	350
R1ZUE52-120		500	450
R1ZUE62-120		600	550
R1ZUE82-120		800	750
R1ZUE42-140	1400	400	350
R1ZUE52-140		500	450
R1ZUE62-140		600	550
R1ZUE82-140		800	750
R1ZUE42-160	1600	400	350
R1ZUE52-160		500	450
R1ZUE62-160		600	550
R1ZUE82-160		800	750
R1ZUE42-180	1800	400	350
R1ZUE52-180		500	450
R1ZUE62-180		600	550
R1ZUE82-180		800	750
R1ZUE42-200	2000	400	350
R1ZUE52-200		500	450
R1ZUE62-200		600	550
R1ZUE82-200		800	750
R1ZUE42-220	2200	400	350
R1ZUE52-220		500	450
R1ZUE62-220		600	550
R1ZUE82-220		800	750
R1ZUE42-240	2400	400	350
R1ZUE52-240		500	450
R1ZUE62-240		600	550

■ Accessori armadi

Enclosure accessories

Zoccolo unico in lamiera pressopiegata per CQE

Solid plinth of press-formed steel for CQE



H 200

CODICE CODE	LARGHEZZA (mm) WIDTH (mm)	DIMENSIONI, MM DIMENSIONS, MM	
		PROFONDITÀ (mm) DEPTH (mm)	B B
R1ZUE82-240	2400	800	750
R1ZUE42-260		400	350
R1ZUE52-260		500	450
R1ZUE62-260		600	550
R1ZUE82-260		800	750
R1ZUE42-280		400	350
R1ZUE52-280		500	450
R1ZUE62-280		600	550
R1ZUE82-280		800	750
R1ZUE42-300		400	350
R1ZUE52-300		500	450
R1ZUE62-300		600	550
R1ZUE82-300		800	750
R1ZUE42-320		400	350
R1ZUE52-320		500	450
R1ZUE62-320		600	550
R1ZUE82-320		800	750
R1ZUE42-340		400	350
R1ZUE52-340		500	450
R1ZUE62-340		600	550
R1ZUE82-340		800	750
R1ZUE42-360		400	350
R1ZUE52-360		500	450
R1ZUE62-360		600	550
R1ZUE82-360		800	750
R1ZUE42-380		400	350
R1ZUE52-380		500	450
R1ZUE62-380		600	550
R1ZUE82-380		800	750
R1ZUE42-400		400	350
R1ZUE52-400		500	450
R1ZUE62-400		600	550
R1ZUE82-400		800	750
R1ZUE42-420		400	350
R1ZUE52-420		500	450
R1ZUE62-420		600	550
R1ZUE82-420		800	750
R1ZUE42-440		400	350
R1ZUE52-440		500	450
R1ZUE62-440		600	550
R1ZUE82-440		800	750
R1ZUE42-460		400	350
R1ZUE52-460		500	450
R1ZUE62-460		600	550
R1ZUE82-460		800	750
R1ZUE42-480		400	350
R1ZUE52-480		500	450
R1ZUE62-480		600	550

■ Accessori armadi

Enclosure accessories

Zoccolo unico in lamiera pressopiegata per CQE

Solid plinth of press-formed steel for CQE



H 200

CODICE CODE	LARGHEZZA (mm) WIDTH (mm)	DIMENSIONI, MM DIMENSIONS, MM	
		PROFONDITÀ (mm) DEPTH (mm)	B B
R1ZUE82-480	4800	800	750
R1ZUE42-500		400	350
R1ZUE52-500		500	450
R1ZUE62-500		600	550
R1ZUE82-500		800	750
R1ZUE42-520		400	350
R1ZUE52-520		500	450
R1ZUE62-520	5200	600	550
R1ZUE82-520		800	750
R1ZUE42-540		400	350
R1ZUE52-540		500	450
R1ZUE62-540	5400	600	550
R1ZUE82-540		800	750
R1ZUE42-560		400	350
R1ZUE52-560		500	450
R1ZUE62-560	5600	600	550
R1ZUE82-560		800	750
R1ZUE42-580		400	350
R1ZUE52-580		500	450
R1ZUE62-580	5800	600	550
R1ZUE82-580		800	750
R1ZUE42-600		400	350
R1ZUE52-600		500	450
R1ZUE62-600	6000	600	550
R1ZUE82-600		800	750
R1ZUE42-620		400	350
R1ZUE52-620		500	450
R1ZUE62-620	6200	600	550
R1ZUE82-620		800	750
R1ZUE42-640		400	350
R1ZUE52-640		500	450
R1ZUE62-640	6400	600	550
R1ZUE82-640		800	750
R1ZUE42-660		400	350
R1ZUE52-660		500	450
R1ZUE62-660	6600	600	550
R1ZUE82-660		800	750
R1ZUE42-680		400	350
R1ZUE52-680		500	450
R1ZUE62-680	6800	600	550
R1ZUE82-680		800	750
R1ZUE42-700		400	350
R1ZUE52-700	7000	500	450

■ Accessori armadi

Enclosure accessories

Zoccolo unico in lamiera pressopiegata per CQE

Solid plinth of press-formed steel for CQE

H 200

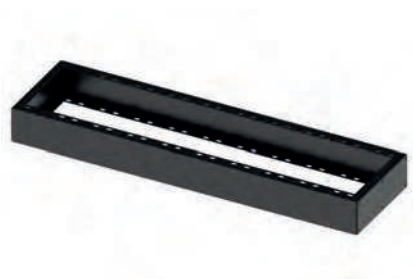

CODICE CODE	LARGHEZZA (mm) WIDTH (mm)	DIMENSIONI, MM DIMENSIONS, MM	
		PROFONDITÀ (mm) DEPTH (mm)	B B
R1ZUE62-700	7000	600	550
R1ZUE82-700		800	750
R1ZUE42-720		400	350
R1ZUE52-720	7200	500	450
R1ZUE62-720		600	550
R1ZUE82-720		800	750
R1ZUE42-740	7400	400	350
R1ZUE52-740		500	450
R1ZUE62-740		600	550
R1ZUE82-740		800	750

■ Accessori armadi Enclosure accessories

Zoccolo a vasca per CQE Blind plinth for CQE



- Realizzato in lamiera d'acciaio sp. 20/10 verniciato RAL 7011 liscio.
- Completo di flange di chiusura laterali (solo su altezza 200) e viteria di montaggio.
- Al momento dell'ordine precisarne la lunghezza.
- Articolo venduto al metro lineare.
- Non può essere applicato sugli armadi della serie CAE.
- In presenza di risalita cavi con accesso frontale larghezza 300 mm, in fase d'ordine fornire la configurazione della batteria di armadi per la foratura.

- Made of 20/10 thick steel, painted smooth RAL 7011.
- Complete with side flanges (only for 200 height) and screws for assembly.
- The required length is to be specified at the order.
- Sold by the linear meter.
- Not applicable to CAE enclosure.
- In case of a 300 mm wide cable chamber with front access, the battery of enclosures configuration system is to be provided with the order for appropriate plinth drilling.

H 100

CODICE CODE	LARGHEZZA (mm) WIDTH (mm)	DIMENSIONI, MM DIMENSIONS, MM	
		PROFONDITÀ (mm) DEPTH (mm)	B B
R1ZVE41-080	800	400	350
R1ZVE51-080		500	450
R1ZVE61-080		600	550
R1ZVE81-080		800	750
R1ZVE41-100	1000	400	350
R1ZVE51-100		500	450
R1ZVE61-100		600	550
R1ZVE81-100		800	750
R1ZVE41-120	1200	400	350
R1ZVE51-120		500	450
R1ZVE61-120		600	550
R1ZVE81-120		800	750
R1ZVE41-140	1400	400	350
R1ZVE51-140		500	450
R1ZVE61-140		600	550
R1ZVE81-140		800	750
R1ZVE41-160	1600	400	350
R1ZVE51-160		500	450
R1ZVE61-160		600	550
R1ZVE81-160		800	750
R1ZVE41-180	1800	400	350
R1ZVE51-180		500	450
R1ZVE61-180		600	550
R1ZVE81-180		800	750
R1ZVE41-200	2000	400	350
R1ZVE51-200		500	450
R1ZVE61-200		600	550
R1ZVE81-200		800	750
R1ZVE41-220	2200	400	350
R1ZVE51-220		500	450
R1ZVE61-220		600	550

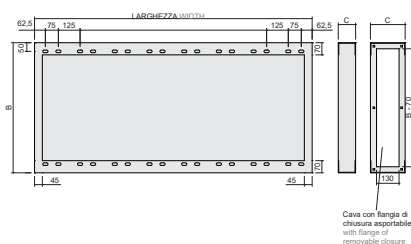

■ Accessori armadi

Enclosure accessories

Zoccolo a vasca per CQE

Blind plinth for CQE



H 100

CODICE CODE	LARGHEZZA (mm) WIDTH (mm)	DIMENSIONI, MM DIMENSIONS, MM	
		PROFONDITÀ (mm) DEPTH (mm)	B B
R1ZVE81-220	2200	800	750
R1ZVE41-240		400	350
R1ZVE51-240		500	450
R1ZVE61-240	2400	600	550
R1ZVE81-240		800	750
R1ZVE41-260		400	350
R1ZVE51-260		500	450
R1ZVE61-260	2600	600	550
R1ZVE81-260		800	750
R1ZVE41-280		400	350
R1ZVE51-280		500	450
R1ZVE61-280	2800	600	550
R1ZVE81-280		800	750
R1ZVE41-300		400	350
R1ZVE51-300		500	450
R1ZVE61-300	3000	600	550
R1ZVE81-300		800	750
R1ZVE41-320		400	350
R1ZVE51-320		500	450
R1ZVE61-320	3200	600	550
R1ZVE81-320		800	750
R1ZVE41-340		400	350
R1ZVE51-340		500	450
R1ZVE61-340	3400	600	550
R1ZVE81-340		800	750
R1ZVE41-360		400	350
R1ZVE51-360		500	450
R1ZVE61-360	3600	600	550
R1ZVE81-360		800	750
R1ZVE41-380		400	350
R1ZVE51-380		500	450
R1ZVE61-380	3800	600	550
R1ZVE81-380		800	750
R1ZVE41-400		400	350
R1ZVE51-400		500	450
R1ZVE61-400	4000	600	550
R1ZVE81-400		800	750
R1ZVE41-420		400	350
R1ZVE51-420		500	450
R1ZVE61-420	4200	600	550
R1ZVE81-420		800	750
R1ZVE41-440		400	350
R1ZVE51-440		500	450
R1ZVE61-440	4400	600	550
R1ZVE81-440		800	750
R1ZVE41-460		400	350
R1ZVE51-460		500	450
R1ZVE61-460	4600	600	550

■ Accessori armadi

Enclosure accessories

Zoccolo a vasca per CQE

Blind plinth for CQE



H 100

CODICE CODE	LARGHEZZA (mm) WIDTH (mm)	DIMENSIONI, MM DIMENSIONS, MM	
		PROFONDITÀ (mm) DEPTH (mm)	B B
R1ZVE81-460	4600	800	750
R1ZVE41-480		400	350
R1ZVE51-480		500	450
R1ZVE61-480	4800	600	550
R1ZVE81-480		800	750
R1ZVE41-500		400	350
R1ZVE51-500		500	450
R1ZVE61-500	5000	600	550
R1ZVE81-500		800	750
R1ZVE41-520		400	350
R1ZVE51-520		500	450
R1ZVE61-520	5200	600	550
R1ZVE81-520		800	750
R1ZVE41-540		400	350
R1ZVE51-540		500	450
R1ZVE61-540	5400	600	550
R1ZVE81-540		800	750
R1ZVE41-560		400	350
R1ZVE51-560		500	450
R1ZVE61-560	5600	600	550
R1ZVE81-560		800	750
R1ZVE41-580		400	350
R1ZVE51-580		500	450
R1ZVE61-580	5800	600	550
R1ZVE81-580		800	750
R1ZVE41-600		400	350
R1ZVE51-600		500	450
R1ZVE61-600	6000	600	550
R1ZVE81-600		800	750
R1ZVE41-620		400	350
R1ZVE51-620		500	450
R1ZVE61-620	6200	600	550
R1ZVE81-620		800	750
R1ZVE41-640		400	350
R1ZVE51-640		500	450
R1ZVE61-640	6400	600	550
R1ZVE81-640		800	750
R1ZVE41-660		400	350
R1ZVE51-660		500	450
R1ZVE61-660	6600	600	550
R1ZVE81-660		800	750
R1ZVE41-680		400	350
R1ZVE51-680		500	450
R1ZVE61-680	6800	600	550
R1ZVE81-680		800	750
R1ZVE41-700		400	350
R1ZVE51-700	7000	500	450

■ Accessori armadi

Enclosure accessories

Zoccolo a vasca per CQE

Blind plinth for CQE



H 100

CODICE CODE	LARGHEZZA (mm) WIDTH (mm)	DIMENSIONI, MM DIMENSIONS, MM	
		PROFONDITÀ (mm) DEPTH (mm)	B B
R1ZVE61-700	7000	600	550
R1ZVE81-700		800	750
R1ZVE41-720		400	350
R1ZVE51-720	7200	500	450
R1ZVE61-720		600	550
R1ZVE81-720		800	750
R1ZVE41-740	7400	400	350
R1ZVE51-740		500	450
R1ZVE61-740		600	550
R1ZVE81-740		800	750

H 200

CODICE CODE	LARGHEZZA (mm) WIDTH (mm)	DIMENSIONI, MM DIMENSIONS, MM	
		PROFONDITÀ (mm) DEPTH (mm)	B B
R1ZVE42-080	800	400	350
R1ZVE52-080		500	450
R1ZVE62-080		600	550
R1ZVE82-080		800	750
R1ZVE42-100	1000	400	350
R1ZVE52-100		500	450
R1ZVE62-100		600	550
R1ZVE82-100		800	750
R1ZVE42-120	1200	400	350
R1ZVE52-120		500	450
R1ZVE62-120		600	550
R1ZVE82-120		800	750
R1ZVE42-140	1400	400	350
R1ZVE52-140		500	450
R1ZVE62-140		600	550
R1ZVE82-140		800	750
R1ZVE42-160	1600	400	350
R1ZVE52-160		500	450
R1ZVE62-160		600	550
R1ZVE82-160		800	750
R1ZVE42-180	1800	400	350
R1ZVE52-180		500	450
R1ZVE62-180		600	550
R1ZVE82-180		800	750
R1ZVE42-200	2000	400	350
R1ZVE52-200		500	450
R1ZVE62-200		600	550
R1ZVE82-200		800	750
R1ZVE42-220	2200	400	350
R1ZVE52-220		500	450
R1ZVE62-220		600	550
R1ZVE82-220		800	750
R1ZVE42-240	2400	400	350
R1ZVE52-240		500	450
R1ZVE62-240		600	550

■ Accessori armadi

Enclosure accessories

Zoccolo a vasca per CQE

Blind plinth for CQE



H 200

CODICE CODE	LARGHEZZA (mm) WIDTH (mm)	DIMENSIONI, MM DIMENSIONS, MM	
		PROFONDITÀ (mm) DEPTH (mm)	B B
R1ZVE82-240	2400	800	750
R1ZVE42-260		400	350
R1ZVE52-260		500	450
R1ZVE62-260		600	550
R1ZVE82-260		800	750
R1ZVE42-280		400	350
R1ZVE52-280		500	450
R1ZVE62-280	2800	600	550
R1ZVE82-280		800	750
R1ZVE42-300		400	350
R1ZVE52-300		500	450
R1ZVE62-300	3000	600	550
R1ZVE82-300		800	750
R1ZVE42-320		400	350
R1ZVE52-320		500	450
R1ZVE62-320	3200	600	550
R1ZVE82-320		800	750
R1ZVE42-340		400	350
R1ZVE52-340		500	450
R1ZVE62-340	3400	600	550
R1ZVE82-340		800	750
R1ZVE42-360		400	350
R1ZVE52-360		500	450
R1ZVE62-360	3600	600	550
R1ZVE82-360		800	750
R1ZVE42-380		400	350
R1ZVE52-380		500	450
R1ZVE62-380	3800	600	550
R1ZVE82-380		800	750
R1ZVE42-400		400	350
R1ZVE52-400		500	450
R1ZVE62-400	4000	600	550
R1ZVE82-400		800	750
R1ZVE42-420		400	350
R1ZVE52-420		500	450
R1ZVE62-420	4200	600	550
R1ZVE82-420		800	750
R1ZVE42-440		400	350
R1ZVE52-440		500	450
R1ZVE62-440	4400	600	550
R1ZVE82-440		800	750
R1ZVE42-460		400	350
R1ZVE52-460		500	450
R1ZVE62-460	4600	600	550
R1ZVE82-460		800	750
R1ZVE42-480		400	350
R1ZVE52-480	4800	500	450
R1ZVE62-480		600	550

■ Accessori armadi

Enclosure accessories

Zoccolo a vasca per CQE

Blind plinth for CQE



H 200

CODICE CODE	LARGHEZZA (mm) WIDTH (mm)	DIMENSIONI, MM DIMENSIONS, MM	
		PROFONDITÀ (mm) DEPTH (mm)	B B
R1ZVE82-480	4800	800	750
R1ZVE42-500		400	350
R1ZVE52-500		500	450
R1ZVE62-500		600	550
R1ZVE82-500		800	750
R1ZVE42-520		400	350
R1ZVE52-520		500	450
R1ZVE62-520	5200	600	550
R1ZVE82-520		800	750
R1ZVE42-540		400	350
R1ZVE52-540		500	450
R1ZVE62-540	5400	600	550
R1ZVE82-540		800	750
R1ZVE42-560		400	350
R1ZVE52-560		500	450
R1ZVE62-560	5600	600	550
R1ZVE82-560		800	750
R1ZVE42-580		400	350
R1ZVE52-580		500	450
R1ZVE62-580	5800	600	550
R1ZVE82-580		800	750
R1ZVE42-600		400	350
R1ZVE52-600		500	450
R1ZVE62-600	6000	600	550
R1ZVE82-600		800	750
R1ZVE42-620		400	350
R1ZVE52-620		500	450
R1ZVE62-620	6200	600	550
R1ZVE82-620		800	750
R1ZVE42-640		400	350
R1ZVE52-640		500	450
R1ZVE62-640	6400	600	550
R1ZVE82-640		800	750
R1ZVE42-660		400	350
R1ZVE52-660		500	450
R1ZVE62-660	6600	600	550
R1ZVE82-660		800	750
R1ZVE42-680		400	350
R1ZVE52-680		500	450
R1ZVE62-680	6800	600	550
R1ZVE82-680		800	750
R1ZVE42-700		400	350
R1ZVE52-700	7000	500	450

■ Accessori armadi Enclosure accessories

Zoccolo a vasca per CQE Blind plinth for CQE



H 200

CODICE CODE	LARGHEZZA (mm) WIDTH (mm)	DIMENSIONI, MM DIMENSIONS, MM	
		PROFONDITÀ (mm) DEPTH (mm)	B B
R1ZVE62-700	7000	600	550
R1ZVE82-700		800	750
R1ZVE42-720		400	350
R1ZVE52-720	7200	500	450
R1ZVE62-720		600	550
R1ZVE82-720		800	750
R1ZVE42-740	7400	400	350
R1ZVE52-740		500	450
R1ZVE62-740		600	550
R1ZVE82-740		800	750

Zoccolo antivibrante per CQE e CAE Antivibration plinth for CQE and CAE

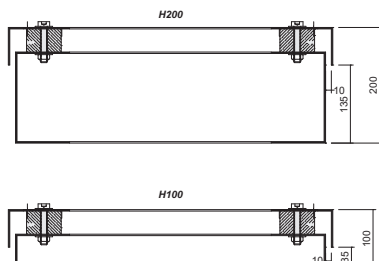

- Realizzato in lamiera d'acciaio sp. 25/10 verniciato RAL 7011 liscio.
- Disponibile nelle altezze 100 e 200 mm.
- Completo di antivibranti e viteria per il montaggio.
- Articolo fornito su richiesta. Al momento dell'ordine indicare la larghezza dell'armadio.
- Articolo venduto a metro lineare.

**Non idoneo agli armadi in batteria.
Specificare nell'ordine la lunghezza.**

- Made of 25/10 thick steel sheet, painted smooth RAL 7011.
- Available with 100 and 200 mm height.
- Complete with vibration dampers and fasteners.
- Available upon request. The enclosure length is to be specified during the order.
- Sold by the linear meter.

**Not suitable for enclosures in battery.
Specify the length in the order.**

H 100

CODICE CODE	DIMENSIONI, MM DIMENSIONS, MM	
	PROFONDITÀ (mm) DEPTH (mm)	B B
R1ZAE41	400	
R1ZAE51	500	
R1ZAE61	600	
R1ZAE81	800	

H 200

CODICE CODE	DIMENSIONI, MM DIMENSIONS, MM	
	PROFONDITÀ (mm) DEPTH (mm)	B B
R1ZAE42	400	
R1ZAE52	500	
R1ZAE62	600	
R1ZAE82	800	

■ Accessori armadi Enclosure accessories

Zoccoli modulari Modular Plinths

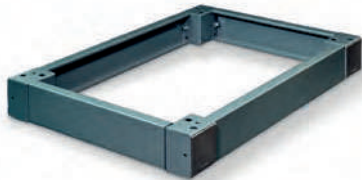

Gli zoccoli sono realizzati abbinando:
angolare + flangia frontale + flangia laterale.

- Angolare realizzato in lamiera d'acciaio sp. 25/10 verniciato RAL 7011 bucciato.
- Flange frontali e laterali in lamiera d'acciaio sp. 15/10 verniciato RAL 7011 bucciato.
- Completo di viteria per il montaggio.

The plinths are made by combining:
angular + front flange + side flange.

- Angular steel sheet 25/10 thick painted RAL 7011 textured.
- Front and side flanges in steel sheet 15/10 thick painted RAL 7011 textured.
- Complete with mounting bolts and screws.

H 100



DIMENSIONI ARMADIO ENCLOSURE DIMENSIONS		ANGOLARE ANGULAR	ZOCOLO H.100 PLINTH H.100	
LARGHEZZA WIDTH	PROFONDITÀ DEPTH		FLANGIA FRONTALE FRONT FLANGE	FLANGIA LATERALE SIDE FLANGE
300	300	R1ZCOR1	R1ZPRO301	R1ZPRO301
	400			R1ZPRO401
	500			R1ZPRO501
	600			R1ZPRO601
400	800		R1ZPRO801	
	300		R1ZPRO301	
	400		R1ZPRO401	
	500		R1ZPRO501	
600	600		R1ZPRO601	
	800		R1ZPRO801	
	300		R1ZPRO301	
	400		R1ZPRO401	
800	500		R1ZPRO501	
	600		R1ZPRO601	
	800		R1ZPRO801	
	400		R1ZPRO401	
1000	500	R1ZPRO501		
	600	R1ZPRO601		
	800	R1ZPRO801		
**1200	400	R1ZPRO401		
	500	R1ZPRO501		



■ Accessori armadi Enclosure accessories

Zoccoli modulari Modular Plinths

H 100

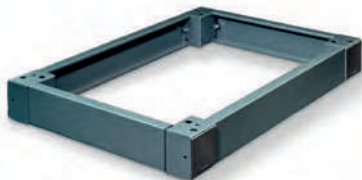

DIMENSIONI ARMADIO ENCLOSURE DIMENSIONS		ANGOLARE ANGULAR	ZOCOLO H.100 PLINTH H.100	
LARGHEZZA WIDTH	PROFONDITÀ DEPTH		FLANGIA FRONTALE FRONT FLANGE	FLANGIA LATERALE SIDE FLANGE
**1200	600	R1ZCOR1	R1ZPRO1201	R1ZPRO601
	800			R1ZPRO801
**1400	400		R1ZPRO1401	R1ZPRO401
	500			R1ZPRO501
	600			R1ZPRO601
	800			R1ZPRO801
**1600	400		R1ZPRO1601	R1ZPRO401
	500			R1ZPRO501
	600			R1ZPRO601
	800			R1ZPRO801

H 200



DIMENSIONI ARMADIO ENCLOSURE DIMENSIONS		ANGOLARE ANGULAR	ZOCOLO H.200 PLINTH H.200	
LARGHEZZA WIDTH	PROFONDITÀ DEPTH		FLANGIA FRONTALE FRONT FLANGE	FLANGIA LATERALE SIDE FLANGE
300	300	R1ZCOR2	R1ZPRO302	R1ZPRO302
	400			R1ZPRO402
	500			R1ZPRO502
	600			R1ZPRO602
400	800		R1ZPRO402	R1ZPRO802
	300			R1ZPRO302
	400			R1ZPRO402
	500			R1ZPRO502
600	600		R1ZPRO602	R1ZPRO602
	800			R1ZPRO802
	300			R1ZPRO302
	400			R1ZPRO402
800	500		R1ZPRO802	R1ZPRO502
	600			R1ZPRO602
	800			R1ZPRO802
	1000			R1ZPRO1002

■ Accessori armadi Enclosure accessories

Zoccoli modulari Modular Plinths

H 200



DIMENSIONI ARMADIO ENCLOSURE DIMENSIONS		ANGOLARE ANGULAR	ZOCOLO H.200 PLINTH H.200	
LARGHEZZA WIDTH	PROFONDITÀ DEPTH		FLANGIA FRONTALE FRONT FLANGE	FLANGIA LATERALE SIDE FLANGE
	500			R1ZPRO502
1000	600		R1ZPRO1002	R1ZPRO602
	800			R1ZPRO802
	400			R1ZPRO402
**1200	500		R1ZPRO1202	R1ZPRO502
	600			R1ZPRO602
	800			R1ZPRO802
	400	R1ZCOR2		R1ZPRO402
**1400	500		R1ZPRO1402	R1ZPRO502
	600			R1ZPRO602
	800			R1ZPRO802
	400			R1ZPRO402
**1600	500		R1ZPRO1602	R1ZPRO502
	600			R1ZPRO602
	800			R1ZPRO802

■ Accessori armadi Enclosure accessories

Zoccolo per Vano Cavi Plinth for Cable compartment

Zoccolo completo H.100 per vano cavi CQE.

Complete plinth for CQE cable compartment.



H 100

CODICE CODE	LARGHEZZA (mm) WIDTH (mm)	DIMENSIONI, MM
		DIMENSIONS, MM
		PROFONDITÀ (mm) DEPTH (mm)
R1ZC20401	200	400
R1ZC20501		500
R1ZC20601		600
R1ZC20801		800

H 200

CODICE CODE	LARGHEZZA (mm) WIDTH (mm)	DIMENSIONI, MM
		DIMENSIONS, MM
		PROFONDITÀ (mm) DEPTH (mm)
R1ZC20402	200	400
R1ZC20502		500
R1ZC20602		600
R1ZC20802		800



■ Accessori armadi

Enclosure accessories

Staffe di fissaggio zoccolo Tipo A

Plinth fixing brackets Type A



- Realizzate in lamiera d'acciaio zincata sp. 25/10.
 - Confezione da 4 pezzi.
- Sono disponibili due tipologie di staffe per i nuovi zoccoli H100 e H200.

- Made of galvanized steel sheet 25/10 thick.
- Pack of 4 pieces.

Two types of brackets are available for the new H100 and H200 plinths.

CODICE CODE	DIMENSIONI, MM DIMENSIONS, MM PESO NETTO (kg) NET WEIGHT (kg)
RZKFSCOR02	0,1615

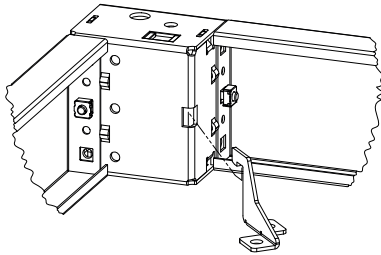

■ Accessori armadi

Enclosure accessories

Staffe Fissaggio Zoccolo Tipo B

Plinth fixing brackets Type B



- Realizzate in lamiera d'acciaio zincata sp. 25/10.
 - Confezione da 4 pezzi.
- Sono disponibili due tipologie di staffe per i nuovi zoccoli H100 e H200.

- Made of galvanized steel sheet 25/10 thick.
- Pack of 4 pieces.

Two types of brackets are available for the new H100 and H200 plinths.

CODICE CODE	DIMENSIONI, MM DIMENSIONS, MM PESO NETTO (kg) NET WEIGHT (kg)
RZKFSCOR01	1,243

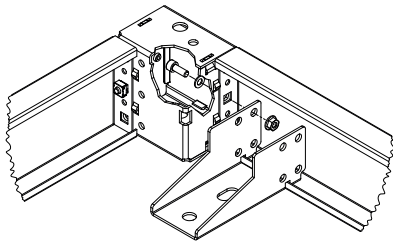

■ Accessori armadi

Enclosure accessories

Piedini di livellamento 0-50 mm per CQE e CAE

Levelling feet for CQE and CAE cabinets, range 0-50 mm



- Lunghezza filetto 50 mm.
 - Filetto di fissaggio M12.
 - Altezza totale piedino 70 mm.
 - Consentono di compensare le irregolarità del pavimento.
 - Confezione da 4 pezzi.
 - Carico statico max ca 300 Kg per ogni piedino di livellamento.
 - Da utilizzare sotto la base dell'armadio in assenza dello zoccolo.
- Thread length: 50 mm.
 - M12 thread.
 - Overall foot height: 70 mm.
 - Allow to equalize floor unevenness.
 - Pack of 4 pieces.
 - Max. constant load for each levelling foot: 300 kg.
 - To be applied below the enclosure base when no plinth is used.

CODICE CODE	DIMENSIONI, MM DIMENSIONS, MM CONFEZIONI/PZ PACK/PCS
RAA45	4



■ Accessori armadi

Enclosure accessories

Piedini di livellamento 50-100 mm per CQE e CAE

Levelling feet for CQE and CAE cabinets, range 50-100 mm



- Lunghezza filetto 100 mm.
- Filetto di fissaggio M12.
- Altezza totale piedino 125 mm.
- Consentono di compensare le irregolarità del pavimento.
- Confezione da 4 pezzi completa di piastre di appoggio e viteria per il montaggio.
- Carico statico max ca 300 Kg per ogni piedino di livellamento.

N.B. Da utilizzare direttamente sotto la base degli armadi CQE e CAE o sotto lo zoccolo modulare per gli armadi CQE e CAE.

- Thread length: 100 mm.
- M12 thread.
- Overall foot height: 125 mm.
- Allow to equalize floor unevenness.
- Pack of 4 pieces complete with support plates, accessories and screws for assembly.
- Max. constant load for each levelling foot: 300 kg.

N.B. To be applied directly below the base of CQE and CAE enclosures or below the modular plinth for CQE and CAE.

CODICE CODE	DIMENSIONI, MM DIMENSIONS, MM CONFEZIONI/PZ PACK/PCS
RAA53	4



■ Accessori armadi Enclosure accessories

Supporto ruote per CQE e CAE Castors support for CQE and CAE

- Realizzato in lamiera d'acciaio sp. 20/10 verniciato RAL 7011 bucciato.
- Confezione da 2 pezzi non comprensiva di ruote da ordinare a parte (cod. RZA41).
- Applicabile su armadi serie CQE e CAE.
- Made of 20/10 thick steel sheet painted textured RAL 7011.
- Pack of 2 pieces non including wheels, to be ordered separately (code: RZA41).
- Suitable for CQE and CAE enclosures.

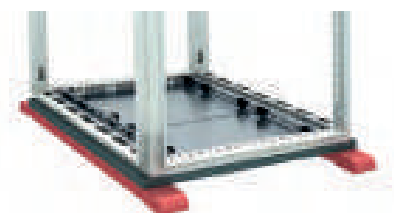

CODICE CODE	DIMENSIONI, MM DIMENSIONS, MM PROFONDITÀ (mm) DEPTH (mm)
R1A46	400
R1A47	500
R1A48	600
R1A49	800
R1A61	1000

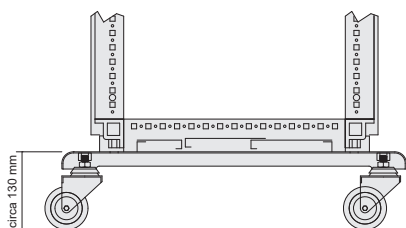

■ Accessori armadi Enclosure accessories

Ruote pivotanti per armadi Pivoting castors for cabinets



- Utilizzabili con supporto ruote oppure direttamente fissate sull'armadio.
- Portata: 80 kg per singola ruota.
- Confezione da 4 ruote (2 con freno e 2 senza freno).

- To be used with wheel supports or directly fixed to the enclosure.
- Load: 80 kg per each castor.
- Pack of 4 pieces (two provided with a break component and two with no break component).

CODICE CODE	DIMENSIONI, MM DIMENSIONS, MM CONFEZIONI/PZ PACK/PCS
RZA41	4

■ Accessori armadi

Enclosure accessories

Fondo unico per armadi per CQE e CAE

Solid bottom for CQE and CAE cabinets

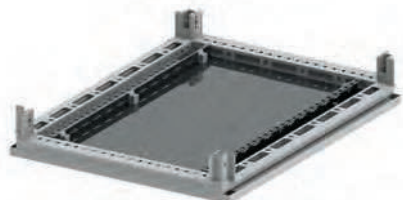

- Realizzato in lamiera d'acciaio zincata sendzimir sp. 20/10.
- Accessorio indispensabile per garantire un grado di protezione IP65 secondo EN 60529/IEC EN 62208 solo per armadi ad anta unica non in batteria.
- Dotato di guarnizione per la tenuta IP e di accessori per il montaggio.

- Made of 20/10 thick galvanized steel.
- Accessory, necessary to guarantee the IP65 protection degree as per EN 60529/ IEC EN 62208 only for single door enclosures not in battery.
- Provided with an IP seal and mounting accessories.

Squadrette per il fissaggio supplementare sugli armadi monoblocco CAE cod. RZCE370.

Complementary brackets for securing CAE monoblock cabinets cod. RZCE370.

CODICE CODE	DIMENSIONI, MM DIMENSIONS, MM	
	LARGHEZZA (mm) WIDTH (mm)	PROFONDITÀ (mm) DEPTH (mm)
RZFUC44	400	400
RZFUC45		500
RZFUC46		600
RZFUC48		800
RZFUC63	600	300
RZFUC64		400
RZFUC65		500
RZFUC66		600
RZFUC68	800	800
RZFUC83		300
RZFUC84		400
RZFUC85		500
RZFUC86	1000	600
RZFUC88		800
RZFUC103		300
RZFUC104		400
RZFUC105	1200	500
RZFUC106		600
RZFUC108		800
RZFUC124		400
RZFUC125	1200	500
RZFUC126		600

■ Accessori armadi

Enclosure accessories

Profili di guarnizione tenuta fondo universali

Universal bottom sealing profiles



- Permettono il passaggio dei cavi tra le lamiera di fondo, fornendo al contempo un adeguato grado di protezione.
- Dimensioni guarnizione: 25x25 mm.
- Mantengono il grado di protezione dell'armadio se montate correttamente.

- Allow the passage of cables between the bottom plates providing at the same time an appropriate protection degree.
- Seal dimensions: 25 x 25 mm.
- They preserve the enclosure protection degree if mounted in compliance with a masterly practice.

CODICE CODE	DIMENSIONI, MM DIMENSIONS, MM LARGHEZZA (mm) WIDTH (mm)
RZFPC400	400
RZFPC600	600
RZFPC800	800
RZFPC1000	1000
RZFPC1200	1200
RZFPC1400	1400
RZFPC1600	1600

Piastra passacavi per CQE e CAE

Cable gland plate for CQE and CAE cabinets

- Lamiera con ingresso cavi regolabile impiegata per l'utilizzo dei passacavi.
- Materiale: lamiera d'acciaio zincata 15/10.
- Confezione comprensiva di accessori per il montaggio.

- Adjustable cable entry plate used for cable gland application.
- Material: 15/10 thick galvanized steel.
- Complete with mounting accessories.



CODICE CODE	LARGHEZZA (mm) WIDTH (mm)	DIMENSIONI, MM DIMENSIONS, MM APERTURE OPENINGS	CONFEZIONI/PZ PACK/PCS
RZFMP600	600	4	
RZFMP800	800	6	
RZFMP1000	1000	8	
RZFMP1200	1200	10	2

■ Accessori armadi Enclosure accessories

Membrana passacavi Cable grommet

- Impiegati specificatamente nelle lamiere con ingresso cavi, consentono l'ingresso dei cavi con diversi diametri di sezione.
- Materiale: polipropilene per la sezione principale e elastomero termoplastico per il rivestimento superiore.

- Utilized specifically with a cable gland plate, allows the entry of cables with different cross-section diameters.
- Material: polypropylene as the main material and thermoplastic elastomeric material as a surface coating.

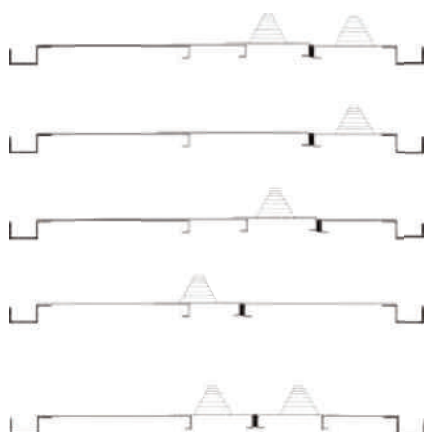

CODICE CODE	QUANTITÀ CAVI PER PASSACAVO NUMBER OF CABLE FOR GROMMET	DIMENSIONI, MM DIMENSIONS, MM	
		SEZIONE MAX DIAMETRO CAVO MAX SECTION CABLE DIAMETER	CONFEZIONI/PZ PACK/PCS
RAMP01	1	47	
RAMP04	4	21	20
RAMP09	9	13	

■ Accessori armadi

Enclosure accessories

Piastra unione per pannelli di cablaggio a inserimento frontale per CQE

Coupler for front-entry mounting plate for CQE cabinets



- Realizzata in lamiera d'acciaio zincata sendzimir sp. 25/10.
- Indicata per dare la continuità dei pannelli di cablaggio in configurazioni con armadi affiancati.
- Dotata di accessori per il montaggio.
- Made of 25/10 thick Sendzimir galvanized steel.
- Suitable to provide the continuity of mounting panels in enclosure systems joined side by side.
- Complete with mounting accessories.

H 1400

CODICE CODE	DIMENSIONI, MM DIMENSIONS, MM LARGHEZZA (mm) WIDTH (mm)
RZPIE14	111

H 1600

CODICE CODE	DIMENSIONI, MM DIMENSIONS, MM LARGHEZZA (mm) WIDTH (mm)
RZPIE16	111

H 1800

CODICE CODE	DIMENSIONI, MM DIMENSIONS, MM LARGHEZZA (mm) WIDTH (mm)
RZPIE18	111

H 2000

CODICE CODE	DIMENSIONI, MM DIMENSIONS, MM LARGHEZZA (mm) WIDTH (mm)
RZPIE20	111

H 2200

CODICE CODE	DIMENSIONI, MM DIMENSIONS, MM LARGHEZZA (mm) WIDTH (mm)
RZPIE22	111

■ Accessori armadi Enclosure accessories

Kit Assemblaggio Quadri Baying kit for CQE



- Confezione completa di 8 distanziali, guarnizione adesiva per la tenuta IP e bulloneria per l'assemblaggio.
- Per quadri particolarmente pesanti si consiglia l'acquisto del kit di rinforzo unione a forma piatta (art. RZKRE65) o a forma di "L" (cod. RZKSRE65).

- Complete with 8 spacers, adhesive seal for IP protection degree and fasteners.
- For particularly heavy systems it is recommended to order a flat (code RZKRE65) or L-shaped (code RZKSRE65) union reinforcement kit.

CODICE CODE	DIMENSIONI, MM DIMENSIONS, MM PESO NETTO (kg) NET WEIGHT (kg)
RZKE65	0,73

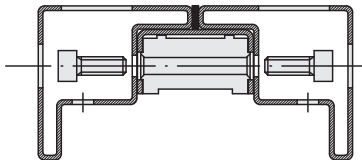

■ Accessori armadi Enclosure accessories

Kit unione sopralzo cavi Cable riser union kit



Kit unione sopralzo cavi art. RAKSU da ordinare se si affiancano più sopralzi (1 cf. da 4 pz).

Coupling kit, code: RAKSU, required if several top compartments are joined together (1 pack of 4 pcs).

CODICE CODE	DIMENSIONI, MM DIMENSIONS, MM CONFEZIONI/PZ PACK/PCS
RAKSU	4

■ Accessori armadi Enclosure accessories

Kit rinforzo unione armadi CQE Baying reinforcement kit for CQE cabinets



- Realizzato in lamiera d'acciaio sp. 30/10 zincata.
- Confezione completa di viteria per il montaggio.

Cod. RZKSRE65 - Forma a "L".

Cod. RZKRE65 - Forma piatta.

- Made 30/10 thick galvanized steel.
- Pack includes screws for assembly.

Cod. RZKSRE65 - L-Shaped.

Cod. RZKRE65 - Flat Shaped.

CODICE CODE	DIMENSIONI, MM DIMENSIONS, MM CONFEZIONI/PZ PACK/PCS
RZKRE65	4
RZKSRE65	

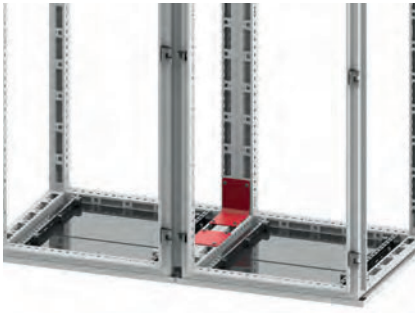

■ Accessori armadi

Enclosure accessories

Kit unione posteriore per CQE

Back-to-back baying kit for CQE



- Tramite questo telaio è possibile unire posteriormente due armadi mantenendo un grado di protezione IP 55 secondo EN 60529/IEC EN 62208.
- Verniciato RAL 7035 bucciato.
- Completo di viteria e di guarnizione per l'assemblaggio.

- With the help of this frame it is possible to join two enclosures back-to-back maintaining the IP55 protection degree as per EN 60529/IEC EN 62208.
- Painted textured RAL 7035.
- Complete with mounting fasteners and seal.

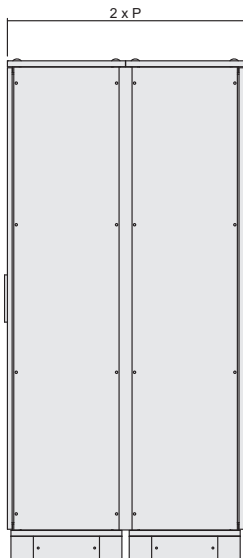

H 1800

CODICE CODE	DIMENSIONI, MM DIMENSIONS, MM LARGHEZZA (mm) WIDTH (mm)
R5KFRE1860	600
R5KFRE1880	800
R5KFRE18100	1000
R5KFRE18120	1200

H 2000

CODICE CODE	DIMENSIONI, MM DIMENSIONS, MM LARGHEZZA (mm) WIDTH (mm)
R5KFRE2040	400
R5KFRE2060	600
R5KFRE2080	800
R5KFRE20100	1000
R5KFRE20120	1200

H 2200

CODICE CODE	DIMENSIONI, MM DIMENSIONS, MM LARGHEZZA (mm) WIDTH (mm)
R5KFRE2240	400
R5KFRE2260	600
R5KFRE2280	800
R5KFRE22100	1000
R5KFRE22120	1200



■ Accessori armadi

Enclosure accessories

Porta cieca per CQE e CAE

Blank door for CQE and CAE



- Realizzata in lamiera d'acciaio sp. 20/10 verniciata RAL 7035 bucciato con bordi antinfortunistici.
- Telaio interno di rinforzo in tubolare zincato.
- 4 cerniere e 4 punti di chiusura.
- Accessori di fissaggio inclusi nella fornitura.
- Mostrina di chiusura con inserto tipo aletta doppio pettine Ø 3 mm.
- Carico massimo: 75 Kg, per armadio H1000 massimo 50 kg.

- Made of 20/10 thick steel sheet painted textured RAL 7035 with safety edges.
- Internal reinforcement frame made of galvanized tubular.
- 4 hinges and 4 closing points.
- Complete with mounting accessories.
- Key escutcheon with with a Ø3mm double-bit lock insert.
- Max. load: 75 kg, for H1000 enclosure max 50 kg.

H 1000

CODICE CODE	LARGHEZZA (mm) WIDTH (mm)	DIMENSIONI, MM DIMENSIONS, MM	
		A A	B B
R5CPE1060	600	955	594
R5CPE1080	800		794
R5CPE10100	1000		994

H 1200

CODICE CODE	LARGHEZZA (mm) WIDTH (mm)	DIMENSIONI, MM DIMENSIONS, MM	
		A A	B B
R5CPE1240	400	1155	394
R5CPE1260	600		594
R5CPE1280	800		794
R5CPE12100	1000		994

H 1400

CODICE CODE	LARGHEZZA (mm) WIDTH (mm)	DIMENSIONI, MM DIMENSIONS, MM	
		A A	B B
R5CPE1460	600	1355	594
R5CPE1480	800		794
R5CPE14100	1000		994

H 1600

CODICE CODE	LARGHEZZA (mm) WIDTH (mm)	DIMENSIONI, MM DIMENSIONS, MM	
		A A	B B
R5CPE1640	400	1555	394
R5CPE1660	600		594
R5CPE1680	800		794
R5CPE16100	1000		994

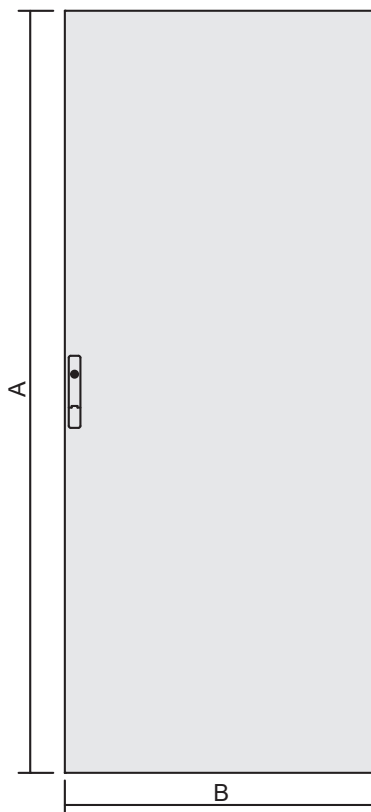

■ Accessori armadi

Enclosure accessories

Porta cieca per CQE e CAE

Blank door for CQE and CAE



H 1800

CODICE CODE	LARGHEZZA (mm) WIDTH (mm)	DIMENSIONI, MM DIMENSIONS, MM	
		A A	B B
R5CPE1830	300	1755	294
R5CPE1840	400		394
R5CPE1860	600		594
R5CPE1880	800		794
R5CPE18100	1000		994

H 2000

CODICE CODE	LARGHEZZA (mm) WIDTH (mm)	DIMENSIONI, MM DIMENSIONS, MM	
		A A	B B
R5CPE2030	300	1955	294
R5CPE2040	400		394
R5CPE2060	600		594
R5CPE2080	800		794
R5CPE20100	1000		994

H 2200

CODICE CODE	LARGHEZZA (mm) WIDTH (mm)	DIMENSIONI, MM DIMENSIONS, MM	
		A A	B B
R5CPE2230	300	2155	294
R5CPE2240	400		394
R5CPE2260	600		594
R5CPE2280	800		794
R5CPE22100	1000		994

■ Accessori armadi

Enclosure accessories

Porta cieca doppia anta per CQE e CAE

Double blank door for CQE and CAE



- Realizzata in lamiera d'acciaio sp. 20/10 verniciata RAL 7035 bucciato con bordi antinfortunistici.
- Telaio interno di rinforzo in tubolare zincato.
- 4 cerniere e 4 punti di chiusura.
- Accessori di fissaggio inclusi nella fornitura.
- Mostrina di chiusura con inserto tipo aletta doppio pettine Ø 3 mm.
- Carico massimo: 75 Kg per anta. Per armadio H1000 massimo 50 kg.

- Made of 20/10 thick steel sheet painted textured RAL 7035 with safety edges.
- Internal reinforcement frame made of galvanized tubular.
- 4 hinges and 4 closing points.
- Complete with mounting accessories.
- Key escutcheon with with a Ø3mm double-bit lock insert.
- Ledged doors of different dimensions available upon request (ie. L - 1000 - 400+600).
- Max. load: 75 kg per each leaf.

H 1200

CODICE CODE	LARGHEZZA (mm) WIDTH (mm)	DIMENSIONI, MM DIMENSIONS, MM	
		A A	B B
R5CPE12101	1000	1155	994
R5CPE12120	1200		1194

H 1400

CODICE CODE	LARGHEZZA (mm) WIDTH (mm)	DIMENSIONI, MM DIMENSIONS, MM	
		A A	B B
R5CPE1481	800		794
R5CPE14120	1200	1355	1194
R5CPE14160	1600		1594

H 1600

CODICE CODE	LARGHEZZA (mm) WIDTH (mm)	DIMENSIONI, MM DIMENSIONS, MM	
		A A	B B
R5CPE1681	800		794
R5CPE16101	1000	1555	994
R5CPE16120	1200		1194

H 1800

CODICE CODE	LARGHEZZA (mm) WIDTH (mm)	DIMENSIONI, MM DIMENSIONS, MM	
		A A	B B
R5CPE1881	800		794
R5CPE18101	1000	1755	-
R5CPE18120	1200		1194

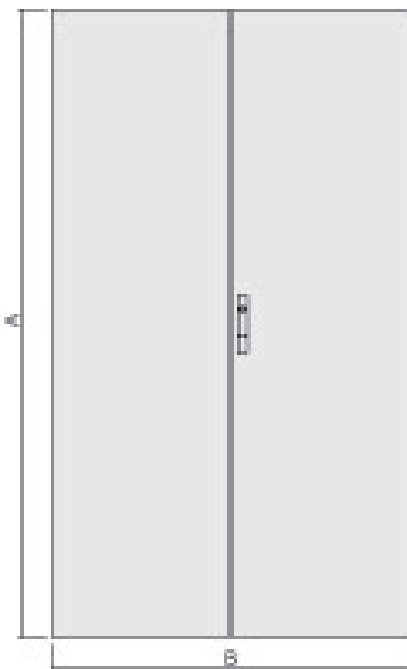

■ Accessori armadi

Enclosure accessories

Porta cieca doppia anta per CQE e CAE

Double blank door for CQE and CAE



H 2000

CODICE CODE	LARGHEZZA (mm) WIDTH (mm)	DIMENSIONI, MM DIMENSIONS, MM	
		A A	B B
R5CPE2081	800		794
R5CPE20101	1000		994
R5CPE20120	1200	1955	1194
R5CPE20140	1400		1394
R5CPE20160	1600		1594

H 2200

CODICE CODE	LARGHEZZA (mm) WIDTH (mm)	DIMENSIONI, MM DIMENSIONS, MM	
		A A	B B
R5CPE2281	800		794
R5CPE22101	1000	2155	994
R5CPE22120	1200		1194

■ Accessori armadi

Enclosure accessories

Porta trasparente per CQE e CAE

Glazed door for CQE and CAE



- Realizzata in lamiera d'acciaio sp. 20/10 verniciata RAL 7035 bucciato.
- 4 cerniere.
- 4 punti di chiusura.
- Accessori di fissaggio inclusi nella fornitura.
- Chiusura completa di inserto tipo aletta doppio pettine Ø 3 mm.
- Vetro di sicurezza sp. 4mm.
- Le porte larghezza 1200 sono a 2 ante.

- Made of 20/10 thick steel sheet painted textured RAL 7035.
- 4 hinges.
- 4 closing points.
- Complete with mounting accessories.
- Locking element complete with a Ø3mm double-bit lock insert.
- 4mm thick safety glass.
- 1200 wide doors are double-folding.

H 1000

CODICE CODE	LARGHEZZA (mm) WIDTH (mm)	DIMENSIONI, MM DIMENSIONS, MM	
		A A	B B
R5CPTE1060	600		594
R5CPTE1080	800	955	794
R5CPTE10100	1000		994

H 1200

CODICE CODE	LARGHEZZA (mm) WIDTH (mm)	DIMENSIONI, MM DIMENSIONS, MM	
		A A	B B
R5CPTE1260	600		594
R5CPTE1280	800	1155	794
R5CPTE12100	1000		994

H 1400

CODICE CODE	LARGHEZZA (mm) WIDTH (mm)	DIMENSIONI, MM DIMENSIONS, MM	
		A A	B B
R5CPTE1460	600		594
R5CPTE1480	800	1355	794
R5CPTE14100	1000		994

H 1600

CODICE CODE	LARGHEZZA (mm) WIDTH (mm)	DIMENSIONI, MM DIMENSIONS, MM	
		A A	B B
R5CPTE1660	600		594
R5CPTE1680	800	1555	794
R5CPTE16100	1000		994

H 1800

CODICE CODE	LARGHEZZA (mm) WIDTH (mm)	DIMENSIONI, MM DIMENSIONS, MM	
		A A	B B
R5CPTE1860	600		594
R5CPTE1880	800		794
R5CPTE18100	1000	1755	994
R5CPTE18120	1200		1194

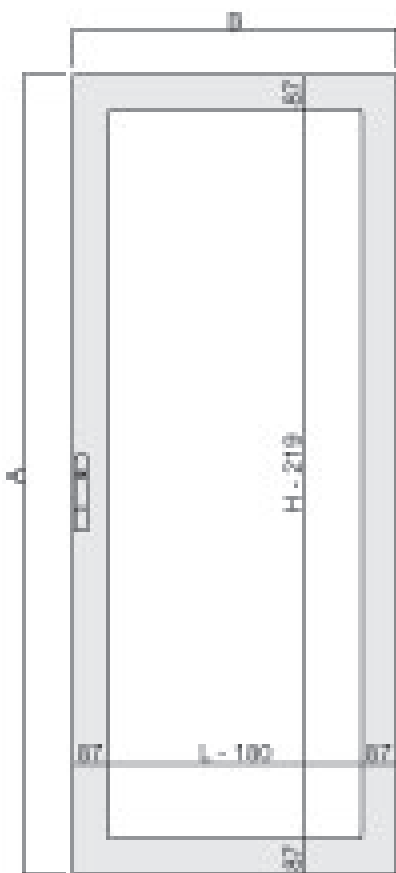

■ Accessori armadi

Enclosure accessories

Porta trasparente per CQE e CAE

Glazed door for CQE and CAE



H 2000

CODICE CODE	LARGHEZZA (mm) WIDTH (mm)	DIMENSIONI, MM DIMENSIONS, MM	
		A A	B B
R5CPTE2060	600	1955	594
R5CPTE2080	800		794
R5CPTE20100	1000		994
R5CPTE20120	1200		1194

H 2200

CODICE CODE	LARGHEZZA (mm) WIDTH (mm)	DIMENSIONI, MM DIMENSIONS, MM	
		A A	B B
R5CPTE2260	600	2155	594
R5CPTE2280	800		794
R5CPTE22100	1000		994
R5CPTE22120	1200		1194

■ Accessori armadi

Enclosure accessories

Porta in vetro serigrafato per CQE e CAE

Screen-printed glazed door for CQE and CAE



- Realizzata in lamiera d'acciaio sp. 20/10 verniciata RAL 7035 bucciato.
- 4 cerniere.
- 4 punti di chiusura.
- Accessori di fissaggio inclusi nella fornitura.
- Chiusura completa di inserto tipo aletta doppio pettine Ø 3 mm.
- Vetro di sicurezza serigrafato fumè spessore 4 mm.

- Made of 20/10 thick steel sheet painted textured RAL 7035.
- 4 hinges.
- 4 closing points.
- Mounting accessories included in the supply.
- Locking element complete with a Ø3mm double-bit lock insert.
- 4 mm thick smoked safety glass.

H 1600

CODICE CODE	LARGHEZZA (mm) WIDTH (mm)	DIMENSIONI, MM DIMENSIONS, MM	
		A A	B B
R5CPTED1660	600	594	1555
R5CPTED1680	800	794	

H 1800

CODICE CODE	LARGHEZZA (mm) WIDTH (mm)	DIMENSIONI, MM DIMENSIONS, MM	
		A A	B B
R5CPTED1860	600	594	1755
R5CPTED1880	800	794	

H 2000

CODICE CODE	LARGHEZZA (mm) WIDTH (mm)	DIMENSIONI, MM DIMENSIONS, MM	
		A A	B B
R5CPTED2060	600	594	1955
R5CPTED2080	800	794	



■ Accessori armadi

Enclosure accessories

Porta laterale per CQE

Side door for CQE



- Realizzata in lamiera d'acciaio sp. 20/10 verniciata RAL 7035 bucciato.
- Telaio interno di rinforzo in tubolare zincato.
- Apertura massima 100° circa.
- Mostrina di chiusura con inserto tipo aletta doppio pettine Ø 3 mm.
- Accessori di fissaggio inclusi nella fornitura.
- Carico massimo: 60 Kg
- Grado di protezione: IP 55 secondo EN 60529/IEC EN 62208.
- Made of 20/10 thick steel sheet painted textured RAL 7035.
- Internal reinforcement frame made of galvanized tubular.
- Max. opening: 100° approximately.
- Key escutcheon with a Ø3mm doublebit lock insert.
- Complete with mounting accessories.
- Max. load: 60 kg.
- Protection degree: IP55 as per EN 60529/IEC EN 62208.

H 1800

CODICE CODE	DIMENSIONI, MM DIMENSIONS, MM
	LARGHEZZA (mm) WIDTH (mm)
R5CPL1850	500
R5CPL1860	600
R5CPL1880	800

H 2000

CODICE CODE	DIMENSIONI, MM DIMENSIONS, MM
	LARGHEZZA (mm) WIDTH (mm)
R5CPL2050	500
R5CPL2060	600
R5CPL2080	800

H 2200

CODICE CODE	DIMENSIONI, MM DIMENSIONS, MM
	LARGHEZZA (mm) WIDTH (mm)
R5CPL2250	500
R5CPL2260	600
R5CPL2280	800

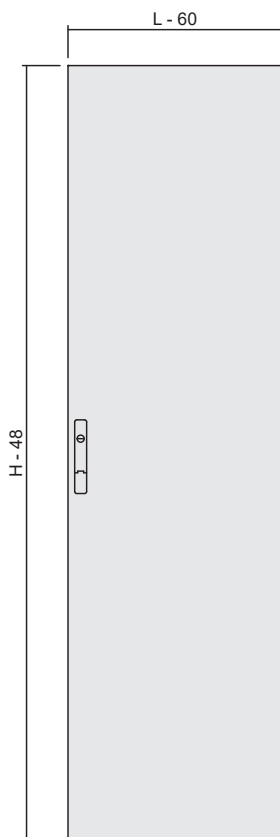

■ Accessori armadi

Enclosure accessories

Traversa di sicurezza per CQE

Safety cross rail for CQE

- Realizzata in legno trattato e verniciato rosso RAL 3000.
- Utilizzabile in alternativa alle porte.
- Particolarmente indicata per locali tecnici o shelter per quadri elettrici.
- Da ordinare in abbinamento alle squadrette di sostegno (RZSTS).

- Made of treated wood painted RAL 3000.
- Usable in substitution of doors.
- Particularly suitable for technical rooms or electrical system shelters.
- Support brackets are also required (RZSTS).



CODICE CODE	DIMENSIONI, MM DIMENSIONS, MM LARGHEZZA (mm) WIDTH (mm)
RATS600	600
RATS800	800
RATS1000	1000
RATS1200	1200

■ Accessori armadi

Enclosure accessories

Squadrette di sostegno per traversa di sicurezza

Support brackets for safety cross rail

- Realizzate in lamiera d'acciaio zincata sendzimir sp. 20/10.
- Confezione da 2 pezzi completa di accessori e viteria per il montaggio.

- Made of 20/10 thick Sendzimir galvanized steel.
- Pack complete with accessories and screws for assembly.



CODICE CODE	DIMENSIONI, MM DIMENSIONS, MM CONFEZIONI/PZ PACK/PCS
RZSTS	2

■ Accessori armadi

Enclosure accessories

Traversino per porta

Door cross rail



- Realizzata in lamiera d'acciaio sp. 20/10 zincata sendzimir.
- E' ancorato direttamente sul tubolare di rinforzo già presente sulle porte cieche.
- Utilizzato come strumento di fissaggio per canaline o altri accessori.
- Confezione da 10 pezzi completati viteria per il montaggio.

- Made of 20/10 thick Sendzimir galvanized steel.
- To be anchored directly to the tubular reinforcement profile provided on the door (only for blank doors).
- Suitable to fix ducts and other accessories.
- Pack of 10 pieces complete with fasteners.

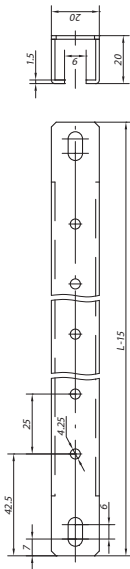

CODICE CODE	DIMENSIONI, MM DIMENSIONS, MM LARGHEZZA (mm) WIDTH (mm)
RZTPE50	500
RZTPE60	600
RZTPE70	700
RZTPE80	800
RZTPE100	1000

■ Accessori armadi

Enclosure accessories

Porta interna per CQE e CAE

Internal door for CQE and CAE



- Realizzata in lamiera d'acciaio sp. 20/10 ribordata e verniciata RAL 7035 bucciato.
- Confezione da 1 pezzo completa di montanti e traverse orizzontali di fissaggio alla struttura.
- Grado di protezione IP 20 secondo EN 60529/IEC EN 62208.
- Fornita di accessori per il montaggio.
- Per la larghezza 1000 porta interna unica, compatibile con porta esterna singola o a doppia anta.
- Le porte larghezza 1200 sono a 2 ante. Da utilizzare solo con porta esterna simmetrica.

- Made of 20/10 thick steel sheet, folded edges, painted textured RAL 7035.
- Pack of 1 piece complete with uprights and horizontal cross rails for mounting to the structure.
- IP 20 protection degree as per EN 60529/IEC EN 62208.
- Complete with mounting accessories.
- In case of 1000 width, the internal single door is compatible with the external single or double door.
- 1200 wide doors are double-folding and are to be used only with a symmetric external door.

H 1000

CODICE CODE	LARGHEZZA (mm) WIDTH (mm)	PORTA INTERNA - A INTERNAL DOOR - A	DIMENSIONI, MM DIMENSIONS, MM	
			PORTA INTERNA - B INTERNAL DOOR - B	PASSAGGIO UTILE - B USEFUL PASSAGE - B
R5PIE1060	600		480	446
R5PIE1080	800	868	680	646
R5PIE10100	1000		880	846

H 1200

CODICE CODE	LARGHEZZA (mm) WIDTH (mm)	PORTA INTERNA - A INTERNAL DOOR - A	DIMENSIONI, MM DIMENSIONS, MM	
			PORTA INTERNA - B INTERNAL DOOR - B	PASSAGGIO UTILE - B USEFUL PASSAGE - B
R5PIE1260	600		480	446
R5PIE1280	800	1068	680	646
R5PIE12100	1000		880	846

H 1400

CODICE CODE	LARGHEZZA (mm) WIDTH (mm)	PORTA INTERNA - A INTERNAL DOOR - A	DIMENSIONI, MM DIMENSIONS, MM	
			PORTA INTERNA - B INTERNAL DOOR - B	PASSAGGIO UTILE - B USEFUL PASSAGE - B
R5PIE1460	600		480	446
R5PIE1480	800	1268	680	646
R5PIE14100	1000		880	846

H 1600

CODICE CODE	LARGHEZZA (mm) WIDTH (mm)	PORTA INTERNA - A INTERNAL DOOR - A	DIMENSIONI, MM DIMENSIONS, MM	
			PORTA INTERNA - B INTERNAL DOOR - B	PASSAGGIO UTILE - B USEFUL PASSAGE - B
R5PIE1660	600		480	446
R5PIE1680	800	1468	680	646
R5PIE16100	1000		880	846

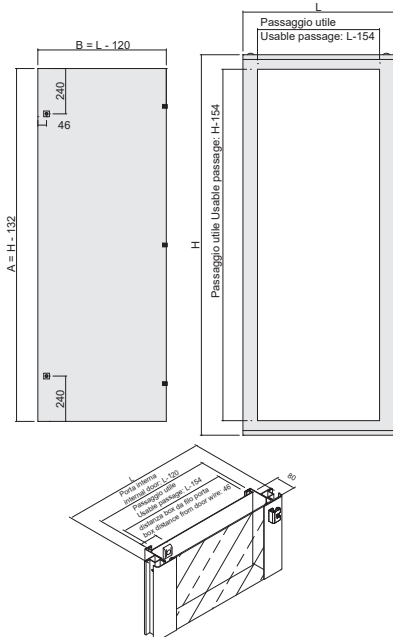

■ Accessori armadi

Enclosure accessories

Porta interna per CQE e CAE

Internal door for CQE and CAE



H 1800

CODICE CODE	LARGHEZZA (mm) WIDTH (mm)	PORTA INTERNA - A INTERNAL DOOR - A	DIMENSIONI, MM DIMENSIONS, MM		
			PORTA INTERNA - B INTERNAL DOOR - B	PASSAGGIO UTILE - A USEFUL PASSAGE - A	PASSAGGIO UTILE - B USEFUL PASSAGE - B
R5PIE1860	600	1668	480	1646	446
R5PIE1880	800		680		646
R5PIE18100	1000		880		846
R5PIE18120	1200		540x2		1046

H 2000

CODICE CODE	LARGHEZZA (mm) WIDTH (mm)	PORTA INTERNA - A INTERNAL DOOR - A	DIMENSIONI, MM DIMENSIONS, MM		
			PORTA INTERNA - B INTERNAL DOOR - B	PASSAGGIO UTILE - A USEFUL PASSAGE - A	PASSAGGIO UTILE - B USEFUL PASSAGE - B
R5PIE2060	600	1868	480	1846	446
R5PIE2080	800		680		646
R5PIE20100	1000		880		846
R5PIE20120	1200		540x2		1046

H 2200

CODICE CODE	LARGHEZZA (mm) WIDTH (mm)	PORTA INTERNA - A INTERNAL DOOR - A	DIMENSIONI, MM DIMENSIONS, MM		
			PORTA INTERNA - B INTERNAL DOOR - B	PASSAGGIO UTILE - A USEFUL PASSAGE - A	PASSAGGIO UTILE - B USEFUL PASSAGE - B
R5PIE2260	600	2068	480	2046	446
R5PIE2280	800		680		646
R5PIE22100	1000		880		846
R5PIE22120	1200		540x2		1046

■ Accessori armadi

Enclosure accessories

Blocco Porta Meccanico per CQE

Mechanical door interlock fo CQE



- Realizzato in lamiera d'acciaio sp. 25/10 zincata sendzimir.
- Consente l'apertura di una porta ausiliaria conseguentemente all'apertura di una principale.
- Confezione completa di viteria per il montaggio.

Cod. RZAE01: Blocco per porte in sequenza.

Cod. RZAE01: Blocco per porte in sequenza.
Cod. RZAE01: Blocco per porte in sequenza.

- Made of 25/10 thick Sendzimir galvanized steel.
- Allows the opening of an auxiliary door as a result of the opening of a main one.
- Complete with accessories and screws for assembly.

Cod. RZAE01: Interlock for sequential doors.

Cod. RZAE01: Interlock for sequential doors.
Cod. RZAE01: Interlock for sequential doors.

CODICE CODE	DIMENSIONI, MM DIMENSIONS, MM CONFEZIONI/PZ PACK/PCS
RZAE01	1
RZAE01	1

BLOCCO PORTA TIPO RZAE01 ARMADI CON APERTURA IN SEQUENZA ANTA SINGOLA

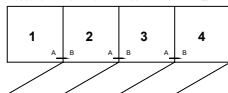

BLOCCO PORTA TIPO RZAE01 ARMADI CON PORTE A DOPPIA ANTA

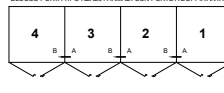

BLOCCO PORTA TIPO RZAE01 ARMADI CON APERTURA A LIBRO

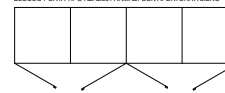

BLOCCO PORTA TIPO RZAE01 ARMADI CON APERTURA IN SEQUENZA ANTA SINGOLA



BLOCCO PORTA TIPO RZAE01 ARMADI CON PORTE A DOPPIA ANTA



■ Accessori armadi

Enclosure accessories

Blocco Porta Antivento

Windproof blank door stop



- Realizzato in lamiera d'acciaio sp. 20/10 zincata sendzimir.
 - Studiato per impedire la chiusura accidentale della porta bloccandone l'apertura a 90°.
 - Completa di accessori per il montaggio.
- Cod. RZAE02: per porte cieche.**
Cod. RZAE09: per porte trasparenti.

- Made of 20/10 thick Sendzimir galvanized steel.
- Designed to prevent accidental closing of the door by blocking its opening at 90°.
- Complete with mounting accessories.

Cod. RZAE02: for blank doors
Cod. RZAE09: for glazed doors.

CODICE CODE	DIMENSIONI, MM DIMENSIONS, MM CONFEZIONI/PZ PACK/PCS
RZAE02	
RZAE09	1

Cerniera 180° per CQE e CAE

180° Hinge for CQE and CAE



- Realizzate in alluminio estruso verniciate RAL 7011 con polveri termoindurenti.
 - Permettono l'apertura delle porte a 180°.
 - Complete di viteria per il montaggio.
- N.B. Il montaggio delle cerniere 180°, in sostituzione di quelle standard, richiede la foratura aggiuntiva della porta.**

- Made of extruded aluminium painted in RAL 7011 with thermosetting powders.
- Allow the doors to open 180°.
- Complete with screws for assembly.

N.B. Installation of 180° hinges instead of standard ones requires a further door drilling.

CODICE CODE	DIMENSIONI, MM DIMENSIONS, MM CONFEZIONI/PZ PACK/PCS
R1CE248	4

■ Accessori armadi

Enclosure accessories

Blocco porta per armadi in batteria

Door lock for battery cabinets

Consente l'apertura simultanea delle porte in batteria dopo l'apertura della porta principale (RZBS02).

La porta principale può essere singola o a doppia anta su cui è possibile montare la maniglia con serratura a chiave RPCE201.

Il codice RZBS01 è da ordinare solo in caso di presenza del Blocco Sezionatore (Variante USA) installabile solo con il meccanismo di azionamento a leva per i principali interruttori dei seguenti produttori:

- Allen Bradley - 1494 Serie F
- General Electric - TDA Tipo 1 e 2
- Siemens - Serie Max Flex FHOH
- Square D - 9422 A1

It allows the simultaneous opening of the doors in battery after the main door (RZBS02) has been opened.

The main door can be single or double leaf on which it is possible to mount the handle with coded lock RPCE201.

Code RZBS01 must be ordered only in case of presence of the Disconnecting Lock (USA variant) which can be installed only with the lever operating mechanism for the main switches of the following manufacturers:

- Allen Bradley - 1494 F-Series
- General Electric - TDA Type 1 and 2
- Siemens - Max Flex FHOH Series
- Square D - 9422 A1

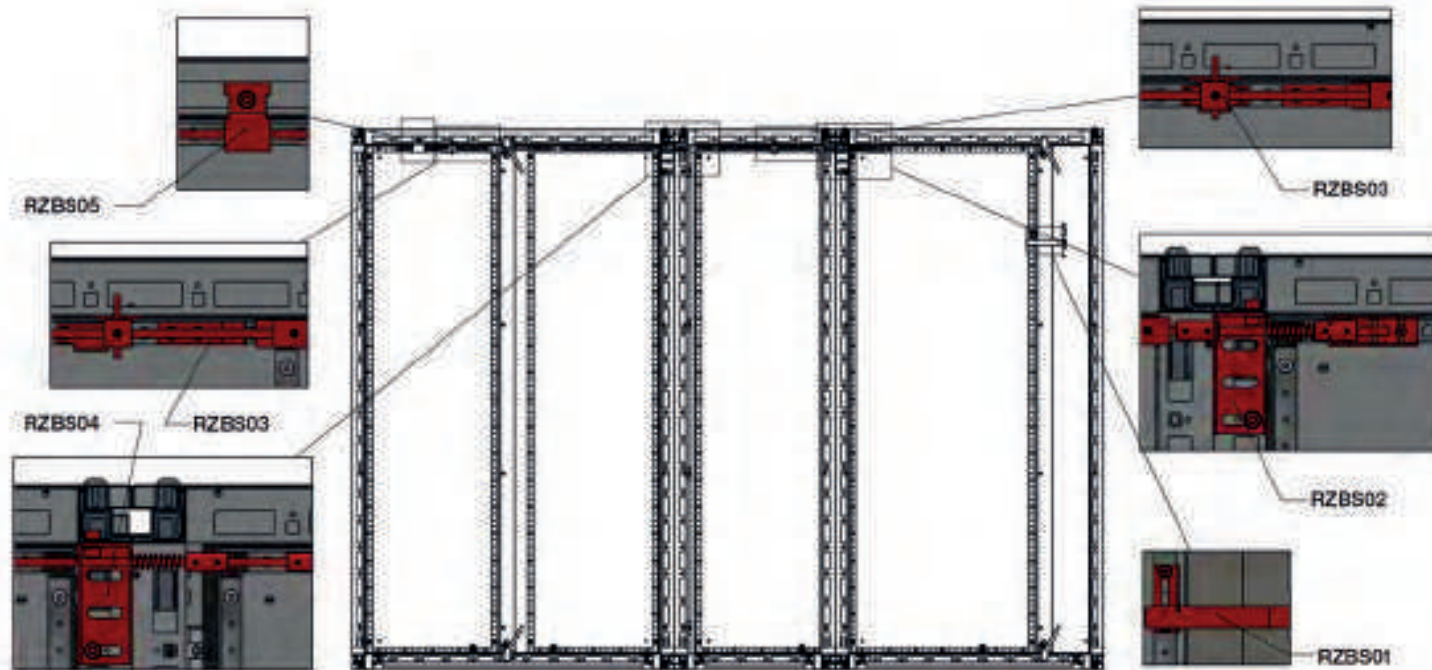

■ Accessori armadi

Enclosure accessories

Blocco di sicurezza porta principale

Main door security lock

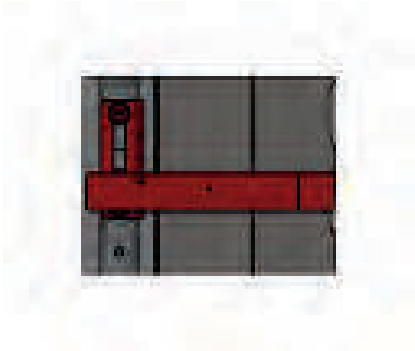

CODICE CODE	DIMENSIONI, MM DIMENSIONS, MM PESO NETTO (kg) NET WEIGHT (kg)
RZBS01	0,28

Disp. azion. armadio interruttore generale

Cabinet circuit breaker operating device

Consente l'apertura simultanea delle porte in batteria dopo l'apertura della porta principale.

It allows the simultaneous opening of the doors in battery after the main door has been opened.

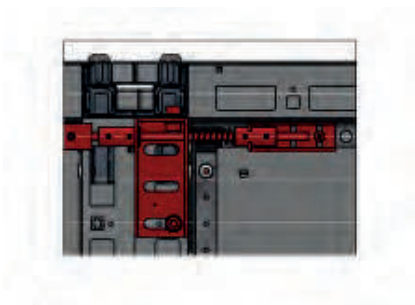

CODICE CODE	DIMENSIONI, MM DIMENSIONS, MM PESO NETTO (kg) NET WEIGHT (kg)
RZBS02	0,58

Blocco porta per armadi in linea

Door block for in-line cabinets

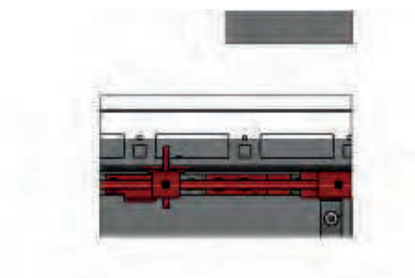

CODICE CODE	DIMENSIONI, MM DIMENSIONS, MM PESO NETTO (kg) NET WEIGHT (kg)
RZBS03	0,28

■ Accessori armadi

Enclosure accessories

Blocco unione aste con staffa sostegno Rod union bushing with support bracket

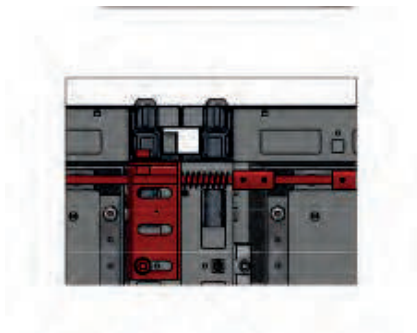

CODICE CODE	DIMENSIONI, MM DIMENSIONS, MM PESO NETTO (kg) NET WEIGHT (kg)
RZBS04	0,41

Sostegno blocco porta aste ultimo armadio Rod door block support for last battery cabinet

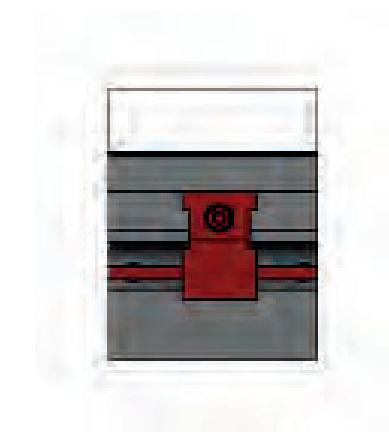

CODICE CODE	DIMENSIONI, MM DIMENSIONS, MM PESO NETTO (kg) NET WEIGHT (kg)
RZBS05	0,12

■ Accessori armadi

Enclosure accessories

Asta blocco porta

Door block rod

Asta blocco porta.

Door block rod.



CODICE CODE	DIMENSIONI, MM DIMENSIONS, MM LARGHEZZA (mm) WIDTH (mm)
RZBS400	400
RZBS600	600
RZBS800	800
RZBS1000	1000
RZBS1200	1200
RZBS1400	1400
RZBS1600	1600

Mostrina

Simple locking



CODICE CODE	DESCRIZIONE DESCRIPTION
RPCE500*	Completa di inserto a doppia aletta d.3 mm con logo DKC compresa di viteria Complete with double-bit insert d.3 mm with DKC logo including screws
RPCE501	Completa di inserto triangolo da 7 mm con logo DKC compresa di viteria Complete with insert Triangle 8 mm with DKC logo including screws
RPCE502	Completa di inserto triangolo da 8 mm con logo DKC compresa di viteria Complete with insert Triangle 8 mm with DKC logo including screws
RPCE503	Completa di inserto quadrato da 7 mm con logo DKC compresa di viteria Complete with insert Square 7 mm with DKC logo including screws
RPCE504	Completa di inserto quadrato da 8 mm con logo DKC compresa di viteria Complete with insert Square 8 mm with DKC logo including screws
RPCE505	Completa di inserto fiat con logo DKC compresa di viteria Complete with insert FIAT type with DKC logo including screws

* Di serie su tutte le porte
* Standard provided with all doors

■ Accessori armadi

Enclosure accessories

Maniglia a leva con modulo

Lever handle with module



CODICE
CODE

DESCRIZIONE
DESCRIPTION

RPCE510

Ergonomica con movimento a leva completa di inserto a doppia aletta d.3 mm con logo DKC compresa di viteria
Ergonomic with lever movement complete with 3 mm double-bit insert with DKC logo including screws

RPCE511

Ergonomica con movimento a leva completa di inserto a chiave cifrata EK333 con logo DKC compresa di viteria
Ergonomic with lever movement complete with coded key insert EK333 with DKC logo including screws

■ Accessori armadi

Enclosure accessories

Maniglia a leva senza modulo

Lever handle without module



Moduli disponibili dal codice RZCE510 al codice RZCE519, altri moduli a richiesta.

Modules available from RZCE510 to RZCE519, other modules on request.

CODICE CODE	DESCRIZIONE DESCRIPTION
RPCE512	Ergonomica con movimento a leva senza modulo con logo DKC compresa di viteria Ergonomic with lever movement and DKC logo without module, including screws
RPCE513	Luchettabile ergonomica con movimento a leva senza modulo con logo DKC compresa di viteria Ergonomic lockable with lever movement and DKC logo without module, including screws

■ Accessori armadi

Enclosure accessories

Moduli di completamento

Completion modules

	CODICE CODE		DESCRIZIONE DESCRIPTION	DIMENSIONI, MM DIMENSIONS, MM
	CHIAVE KEY	INSERTO INSERT		
	RZCE230	RZCE510	Doppio pettine Ø 3 mm Double-bit lock Ø 3 mm	3
	-	RZCE511	Chiave EK 333 Key EK 333	
	RZCE235	RZCE512	Triangolo Triangle	7
	RZCE236	RZCE513		8
	RZCE233	RZCE514	Quadro Square	7
	RZCE234	RZCE515		8
	-	RZCE516	Pulsante Button	-
	-	RZCE517	Chiave Ronis 405E Key Ronis 405E	-
	-	RZCE518	Chiave Ronis 455E Key Ronis 405E	-
	-	RZCE519	Chiave Ronis 2132A Key Ronis 2132A	-

■ Accessori armadi

Enclosure accessories

Retro per CQE e CAE

Rear panel for CQE and CAE



- Realizzato in acciaio sp. 15/10 verniciato RAL 7035 bucciato.
- 8 o più punti di fissaggio alla struttura.
- Carico massimo:
 - larghezza \geq 800 mm: 75 Kg
 - larghezza \leq 600 mm: 90 Kg

Cod. R5CRE20140 e Cod. R5CRE20160
fornito in due parti

- Made of 15/10 thick steel sheet painted textured RAL 7035.
- 8 or more points for mounting to the structure.
- Max. load:
 - Width \geq 800 mm: 75 Kg
 - Width \leq 600 mm: 90 Kg

Cod. R5CRE20140 and Cod. R5CRE20160
two piece provided.

H 1000

CODICE CODE	LARGHEZZA (mm) WIDTH (mm)	DIMENSIONI, MM DIMENSIONS, MM	
		A A	B B
R5CRE1060	600		594
R5CRE1080	800	955	794
R5CRE10100	1000		994

H 1200

CODICE CODE	LARGHEZZA (mm) WIDTH (mm)	DIMENSIONI, MM DIMENSIONS, MM	
		A A	B B
R5CRE1240	400		594
R5CRE1260	600		794
R5CRE1280	800	1155	994
R5CRE12100	1000		1194
	1200		1194

H 1400

CODICE CODE	LARGHEZZA (mm) WIDTH (mm)	DIMENSIONI, MM DIMENSIONS, MM	
		A A	B B
R5CRE1460	600		594
R5CRE1480	800		794
R5CRE14100	1000	1355	994
R5CRE14120	1200		1194
R5CRE14160	1600		1594

H 1600

CODICE CODE	LARGHEZZA (mm) WIDTH (mm)	DIMENSIONI, MM DIMENSIONS, MM	
		A A	B B
R5CRE1640	400		394
R5CRE1660	600		594
R5CRE1680	800	1555	794
R5CRE16100	1000		994
R5CRE16120	1200		1194

■ Accessori armadi

Enclosure accessories

Retro per CQE e CAE

Rear panel for CQE and CAE



H 1800

CODICE CODE	LARGHEZZA (mm) WIDTH (mm)	DIMENSIONI, MM DIMENSIONS, MM	
		A A	B B
R5CRE1830	300	1755	294
R5CRE1840	400		394
R5CRE1860	600		594
R5CRE1880	800		794
R5CRE18100	1000		994
R5CRE18120	1200		1194

H 2000

CODICE CODE	LARGHEZZA (mm) WIDTH (mm)	DIMENSIONI, MM DIMENSIONS, MM	
		A A	B B
R5CRE2030	300	1955	294
R5CRE2040	400		394
R5CRE2060	600		594
R5CRE2080	800		794
R5CRE20100	1000		994
R5CRE20120	1200		1194
R5CRE20140	1400		1394
R5CRE20160	1600		1594

H 2200

CODICE CODE	LARGHEZZA (mm) WIDTH (mm)	DIMENSIONI, MM DIMENSIONS, MM	
		A A	B B
R5CRE2230	300	2155	294
R5CRE2240	400		394
R5CRE2260	600		594
R5CRE2280	800		794
R5CRE22100	1000		994
R5CRE22120	1200		1194

■ Accessori armadi

Enclosure accessories

Laterali per armadio CQE

Side panels for CQE cabinet



- Realizzati in lamiera d'acciaio sp. 15/10 verniciati RAL 7035 bucciato.
 - A partire da 6 punti di fissaggio alla struttura (in funzione della dimensione).
 - Confezione da 2 pezzi completa di accessori per il montaggio.
 - Carico massimo:
 - profondità \geq 800 mm: 75 Kg
 - profondità \leq 600 mm: 90 Kg
- Made of 15/10 thick steel sheet painted textured RAL 7035.
 - 6 or 8 points of mounting to the structure (depending on the dimensions).
 - Pack of 2 pieces complete with mounting accessories.
 - Max. load:
 - depth \geq 800 mm: 75 Kg
 - depth \leq 600 mm: 90 Kg

H 1200

CODICE CODE	PROFONDITÀ (mm) DEPTH (mm)	DIMENSIONI, MM DIMENSIONS, MM	
		ALTEZZA ELEMENTO (mm) ELEMENT HEIGHT (mm)	LARGHEZZA ELEMENTO (mm) ELEMENT WIDTH (mm)
R5LE1242	400	1161	346
R5LE1252	500		446
R5LE1262	600		546
R5LE12102	1000		946

H 1400

CODICE CODE	PROFONDITÀ (mm) DEPTH (mm)	DIMENSIONI, MM DIMENSIONS, MM	
		ALTEZZA ELEMENTO (mm) ELEMENT HEIGHT (mm)	LARGHEZZA ELEMENTO (mm) ELEMENT WIDTH (mm)
R5LE1442	400	1361	346
R5LE1452	500		446

H 1600

CODICE CODE	PROFONDITÀ (mm) DEPTH (mm)	DIMENSIONI, MM DIMENSIONS, MM	
		ALTEZZA ELEMENTO (mm) ELEMENT HEIGHT (mm)	LARGHEZZA ELEMENTO (mm) ELEMENT WIDTH (mm)
R5LE1642	400	1561	346
R5LE1652	500		446
R5LE1662	600		546
R5LE1682	800		746

H 1800

CODICE CODE	PROFONDITÀ (mm) DEPTH (mm)	DIMENSIONI, MM DIMENSIONS, MM	
		ALTEZZA ELEMENTO (mm) ELEMENT HEIGHT (mm)	LARGHEZZA ELEMENTO (mm) ELEMENT WIDTH (mm)
R5LE1832	300	1761	246
R5LE1842	400		346
R5LE1852	500		446
R5LE1862	600		546
R5LE1882	800		746
R5LE18102	1000		946
R5LE18122	1200		1146

■ Accessori armadi

Enclosure accessories

Laterali per armadio CQE

Side panels for CQE cabinet



H 2000

CODICE CODE	PROFONDITÀ (mm) DEPTH (mm)	DIMENSIONI, MM DIMENSIONS, MM	
		ALTEZZA ELEMENTO (mm) ELEMENT HEIGHT (mm)	LARGHEZZA ELEMENTO (mm) ELEMENT WIDTH (mm)
R5LE2032	300	1961	246
R5LE2042	400		346
R5LE2052	500		446
R5LE2062	600		546
R5LE2082	800		746
R5LE20102	1000		946
R5LE20122	1200		1146

H 2200

CODICE CODE	PROFONDITÀ (mm) DEPTH (mm)	DIMENSIONI, MM DIMENSIONS, MM	
		ALTEZZA ELEMENTO (mm) ELEMENT HEIGHT (mm)	LARGHEZZA ELEMENTO (mm) ELEMENT WIDTH (mm)
R5LE2232	300	2161	246
R5LE2242	400		346
R5LE2252	500		446
R5LE2262	600		546
R5LE2282	800		746
R5LE22102	1000		946
R5LE22122	1200		1146

■ Accessori armadi Enclosure accessories

Divisorio verticale per CQE Vertical divider for CQE

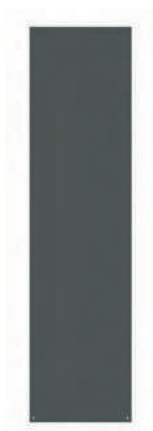

- Realizzato in lamiera d'acciaio zincata sendzimir sp. 15/10.
- Particolarmente utilizzato nella separazione delle batterie di armadi poiché crea una segregazione cieca tra una struttura e l'altra.
- Grado di protezione: IP 30 secondo EN 60529/IEC EN 62208.
- Confezione da 1 pezzo completa di accessori per il montaggio.
- Per versione IP 54 ordinare guarnizione adesiva mm articolo RAA56.

- Made of 15/10 thick Sendzimir galvanized steel
- Particularly used in the separation of cabinet batteries as it creates a blind separation between one structure and another.
- Protection degree: IP30 as per EN60529/IEC EN 62208.
- Pack of 1 piece complete with mounting accessories.
- If IP 54 is required, an adhesive seal 8x3 mm (code RAA56) is to be ordered.

H 1400

CODICE CODE	DIMENSIONI, MM DIMENSIONS, MM
	LARGHEZZA (mm) WIDTH (mm)
RZDVE1440	400
RZDVE1450	500

H 1600

CODICE CODE	DIMENSIONI, MM DIMENSIONS, MM
	LARGHEZZA (mm) WIDTH (mm)
RZDVE1640	400
RZDVE1650	500
RZDVE1660	600

H 1800

CODICE CODE	DIMENSIONI, MM DIMENSIONS, MM
	LARGHEZZA (mm) WIDTH (mm)
RZDVE1830	300
RZDVE1840	400
RZDVE1850	500
RZDVE1860	600
RZDVE1880	800

H 2000

CODICE CODE	DIMENSIONI, MM DIMENSIONS, MM
	LARGHEZZA (mm) WIDTH (mm)
RZDVE2030	300
RZDVE2040	400
RZDVE2050	500
RZDVE2060	600
RZDVE2080	800

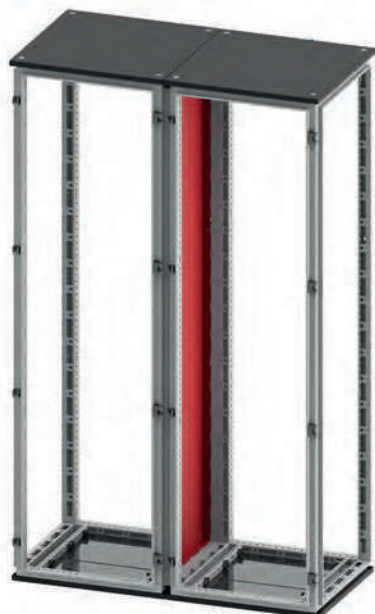

■ Accessori armadi Enclosure accessories

Divisorio verticale per CQE Vertical divider for CQE

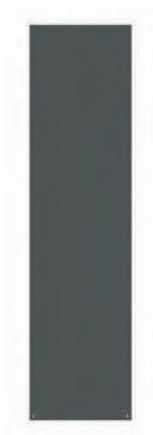

H 2200

CODICE CODE	DIMENSIONI, MM DIMENSIONS, MM LARGHEZZA (mm) WIDTH (mm)
RZDVE2240	400
RZDVE2250	500
RZDVE2260	600
RZDVE2280	800

■ Accessori armadi

Enclosure accessories

Sopralzo passaggio cavi modulare per CQE

Modular cable routing top for CQE



- Realizzato in lamiera d'acciaio sp. 15/10 verniciato RAL 7035 bucciato.
- Da installare sopra l'armadio per consentire lo smistamento cavi oppure in batterie di armadi allineati per permettere la distribuzione di energia tramite sistemi di sbarre di rame.
- Accessibile su tutti i lati tramite pannelli asportabili.
- Completo di accessori per il montaggio.
- Grado di protezione: IP55 secondo EN 60529/IEC EN 62208.
- Da ordinare a parte:
 - Chiusure laterali art. R5LSE (1 cf. da 2 pz.).
 - Pannello intermedio per creare una segregazione tra il sopralzo passaggio cavi e la struttura dell'armadio art. R5PDS (opzionale).
 - Kit unione sopralzo cavi art. RAKSU da ordinare se si affiancano più sopralzi (1 cf. da 4 pz).
- Made of 15/10 thick steel sheet painted textured RAL 7035.
- To be installed above the enclosure to allow cable sorting or in batteries of aligned enclosures to allow power distribution through copper busbar systems.
- Accessible from all the sides via removable panels.
- Complete with mounting accessories.
- Protection degree: IP55 as per EN 60529/IEC EN 62208.
- To be ordered separately:
 - Side panels, code: R5LSE (1 pack of 2 pcs).
 - Intermediate panel to create a separation between the top compartment and the enclosure structure, code: R5PDS (optional).
 - Coupling kit, code: RAKSU, required if several top compartments are joined together (1 pack of 4 pcs).

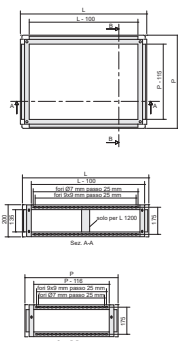

H 200

CODICE CODE	DIMENSIONI, MM DIMENSIONS, MM	
	LARGHEZZA (mm) WIDTH (mm)	PROFONDITÀ (mm) DEPTH (mm)
R5SCE45		500
R5SCE46	400	600
R5SCE48		800
R5SCE65		500
R5SCE66	600	600
R5SCE68		800
R5SCE85		500
R5SCE86	800	600
R5SCE88		800
R5SCE105		500
R5SCE106	1000	600
R5SCE108		800
R5SCE125		500
R5SCE126	1200	600
R5SCE128		800



■ Accessori armadi Enclosure accessories

Pannello intermedio sopralzo passaggio cavi modulare per CQE Intermediate panel for modular cable routing top for CQE



- Realizzato in lamiera d'acciaio sp. 15/10 verniciato RAL 7035 bucciato.
- Pannello intermedio per creare una segregazione tra il sopralzo passaggio cavi e la struttura dell'armadio art. R5PDS (opzionale).

- Made of 15/10 thick steel sheet painted textured RAL 7035.
- Intermediate panel to create a separation between the top compartment and the enclosure structure, code: R5PDS (optional).

CODICE CODE	LARGHEZZA (mm) WIDTH (mm)	DIMENSIONI, MM DIMENSIONS, MM	
		PROFONDITÀ (mm) DEPTH (mm)	
R5PDS45		500	
R5PDS46	400	600	
R5PDS48		800	
R5PDS65		500	
R5PDS66	600	600	
R5PDS68		800	
R5PDS85		500	
R5PDS86	800	600	
R5PDS88		800	
R5PDS105		500	
R5PDS106	1000	600	
R5PDS108		800	
R5PDS125		500	
R5PDS126	1200	600	
R5PDS128		800	

Chiusure laterali per sopralzo passaggio cavi modulare per CQE Side panels for CQE modular cable routing top

Prodotti in confezione da 2 pezzi.

1 pack of 2 pcs.



H 200

CODICE CODE	DIMENSIONI, MM DIMENSIONS, MM	
	PROFONDITÀ (mm) DEPTH (mm)	
R5LSE50	500	
R5LSE60	600	
R5LSE80	800	

■ Accessori armadi

Enclosure accessories

Sopralzo smistamento/raccolta cavi per CQE

Cable sorting/collecting top for CQE



- Realizzato in lamiera d'acciaio sp. 15/10 verniciato RAL 7035 bucciato.
- Specificare in fase d'ordine la lunghezza.
- Lunghezza massima 2000 mm per ogni singolo modulo con possibilità di affiancamento dei medesimi.
- Completo di accessori per il montaggio.
- Grado di protezione: IP 55 secondo EN 60529/IEC EN 62208.
- Articolo fornibile a richiesta venduto a metro lineare.
- Da ordinare a parte: chiusure laterali (art. R5LSC - cf. 2 pz.), squadrette di sollevamento (art. RZTSE02).

- Made of 15/10 thick steel sheet painted textured RAL 7035.
- The required length is to be specified at the order.
- Maximum length of 2000mm for each single module with the possibility of flanking them.
- Complete with mounting accessories.
- Protection degree: IP55 as per EN 60529/IEC EN 62208.
- Available upon request, sold by the linear meter.
- To be ordered separately: side panels (code: R5LSC, 1 pack of 2 pcs), lifting brackets (code RZTSE02).

CODICE CODE	DIMENSIONI, MM DIMENSIONS, MM PROFONDITÀ (mm) DEPTH (mm)
R5SCC50	500
R5SCC60	600
R5SCC80	800

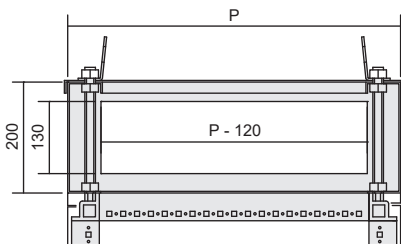

■ Accessori armadi

Enclosure accessories

Chiusure laterali per sopralzo smistamento/raccolta cavi

Side panels for CQE cable sorting/collecting top



Da ordinare a parte: chiusure laterali (art. R5LSC - cf. 2 pz.), squadrette di sollevamento (art. RZTSE02).

To be ordered separately: side panels (code: R5LSC, 1 pack of 2 pcs), lifting brackets (code RZTSE02).

H 200

CODICE CODE	DIMENSIONI, MM DIMENSIONS, MM PROFONDITÀ (mm) DEPTH (mm)
R5LSC50	500
R5LSC60	600
R5LSC80	800

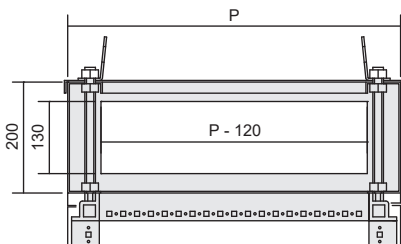

■ Accessori armadi

Enclosure accessories

Vano cavi con apertura laterale per CQE

Cable compartment with side access for CQE cabinet



Telaio

In lamiera d'acciaio sp. 15/10 verniciato RAL 7035 bucciato.

Porta

Reversibile, realizzata in lamiera d'acciaio sp. 20/10 con telaio di rinforzo, verniciata RAL 7035 bucciato.

Ingresso cavi superiore ed inferiore

Con piastra di chiusura in lamiera d'acciaio sp. 15/10, adeguatamente dimensionata alla misura del tetto e del fondo, completa di guarnizione di tenuta.

Composizione

Telaio, porta e ingresso cavi.

Grado di protezione

IP 55 secondo EN 60529/IE EN 62208.

- Completa di accessori per il fissaggio a lato della struttura.

Frame

Made of 15/10 thick steel painted textured RAL 7035.

Door

Reversible, made of 20/10 thick steel, provided with reinforcement frame, painted textured RAL 7035.

Upper and lower cable entry

With 15/10 steel sheet closing plate, adequately sized to the size of the roof and bottom, complete with sealing gasket.

Composition

Frame, door and cable entry.

Protection degree

IP 55 as per EN 60529/IE EN 62208.

- Complete with fasteners for side mounting to the structure.

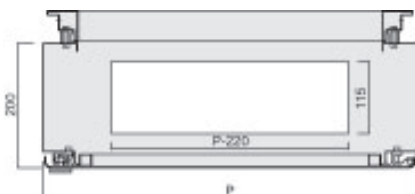

H 1800

CODICE CODE	LARGHEZZA (mm) WIDTH (mm)	DIMENSIONI, MM DIMENSIONS, MM	
		PROFONDITÀ (mm) DEPTH (mm)	
R5CVCE18250	200	500	
R5CVCE18260		600	
R5CVCE18280		800	

H 2000

CODICE CODE	LARGHEZZA (mm) WIDTH (mm)	DIMENSIONI, MM DIMENSIONS, MM	
		PROFONDITÀ (mm) DEPTH (mm)	
R5CVCE20250	200	500	
R5CVCE20260		600	
R5CVCE20280		800	



■ Accessori armadi

Enclosure accessories

Pannello porta connettori per CQE

Connector carrier for CQE cabinets

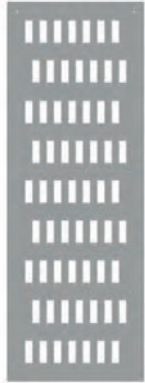

- Realizzato in lamiera d'acciaio zincata sendzimir sp. 20/10.
- Utilizzato come divisorio tra due armadi, permette il fissaggio di connettori standard 24 poli.
- Grado di protezione: IP 30 secondo EN 60529/IEC EN 62208.
- Confezione da 1 pezzo completa di accessori per il montaggio.
- Per versione IP 54 ordinare guarnizione adesiva articolo RAA56.
- Made of 20/10 thick Sendzimir galvanized steel.
- If used as a divider, it allows the installation of standard 24-pole connectors.
- Protection degree: IP30 as per EN 60529/IEC EN 62208.
- Pack of 1 piece complete with mounting accessories.
- If IP 54 is required, an adhesive seal (code RAA56) is to be ordered.

H 1800

CODICE CODE	LARGHEZZA (mm) WIDTH (mm)	DIMENSIONI, MM DIMENSIONS, MM	NUMERO CONNETTORI NUMBER OF CONNECTORS
RZPCDE1840	400		24 (3x8)
RZPCDE1850	500		32 (4x8)
RZPCDE1860	600		40 (5x8)
RZPCDE1880	800		56 (7x8)

H 2000

CODICE CODE	LARGHEZZA (mm) WIDTH (mm)	DIMENSIONI, MM DIMENSIONS, MM	NUMERO CONNETTORI NUMBER OF CONNECTORS
RZPCDE2040	400		27 (3x9)
RZPCDE2050	500		36 (4x9)
RZPCDE2060	600		45 (5x9)
RZPCDE2080	800		63 (7x9)



■ Accessori armadi

Enclosure accessories

Adattatori per pannello porta connettori

Adapters for connector carrier

- Realizzati in lamiera d'acciaio sp. 20/10 zincata
- Confezione da 5 pezzi completa di accessori e viteria per il montaggio

- Made of 20/10 thick galvanized steel
- Pack of 5 pieces complete with mounting accessories and screws for assembly

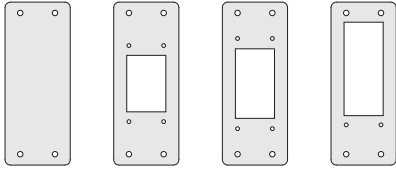

CODICE CODE	DIMENSIONI, MM DIMENSIONS, MM ADATTAMENTO ADAPTER TYPE
RZAD2400	Piastra cieca
RZAD2406	24 - 6
RZAD2410	24 - 10
RZAD2416	24 - 16

Ripiano di lavoro per il montaggio su porta cieca per CQE e CAE

Door tray mountable on blank door for CQE and CAE



- Realizzato in lamiera d'acciaio sp. 15/10 verniciato RAL 7035 bucciato.
- Utile come supporto per strumenti di programmazione oppure come semplice portautensili durante la manutenzione e il cablaggio.
- Confezione da 1 pezzo completa di aste di sostegno e viteria per il montaggio.

- Made of 15/10 thick steel sheet painted textured RAL 7035.
- Suitable as a support for programming tools or as a simple tool holder during maintenance and wiring.
- Pack of 1 piece complete with support bars and fasteners.

CODICE CODE	DIMENSIONI, MM DIMENSIONS, MM LARGHEZZA (mm) WIDTH (mm)
R5RL600	600
R5RL800	800
R5RL1000	1000

■ Accessori armadi

Enclosure accessories

Ripiano Fisso, montaggio al telaio di CQE e CAE

Fixed tray for CQE and CAE



- Realizzati in lamiera d'acciaio sp. 20/10 verniciati RAL 7035 bucciato.
 - Consentono di appoggiare il case del computer, la stampante o qualsiasi altra periferica hardware.
- Portata massima ripiano fisso: Kg 60

- Made of 20/10 thick steel sheet painted textured RAL 7035.
 - Suitable to accommodate a computer case, printer or other hardware.
- Maximum load fixed tray: Kg 60

CODICE CODE	DIMENSIONI, MM DIMENSIONS, MM	
	LARGHEZZA (mm) WIDTH (mm)	PROFONDITÀ (mm) DEPTH (mm)
R5RF640	600	400
R5RF650		500
R5RF660		600
R5RF680		800
R5RF840	800	400
R5RF850		500
R5RF860		600
R5RF880		800
R5RF1040	1000	400
R5RF1050		500
R5RF1060		600
R5RF1080		800

■ Accessori armadi

Enclosure accessories

Ripiano estraibile, montaggio al telaio di CQE e CAE

Sliding tray for CQE and CAE cabinets



- Realizzati in lamiera d'acciaio sp. 20/10 verniciati RAL 7035 bucciato.
 - Consentono di appoggiare il case del computer, la stampante o qualsiasi altra periferica hardware.
- Portata massima ripiano estraibile: Kg 30

- Made of 20/10 thick steel sheet painted textured RAL 7035.
 - Suitable to accommodate a computer case, printer or other hardware.
- Maximum load sliding tray: Kg 30.

CODICE CODE	DIMENSIONI, MM DIMENSIONS, MM	
	LARGHEZZA (mm) WIDTH (mm)	PROFONDITÀ (mm) DEPTH (mm)
R5RE640	600	400
R5RE650		500
R5RE660		600
R5RE680		800
R5RE840	800	400
R5RE850		500
R5RE860		600
R5RE880		800

■ Accessori armadi

Enclosure accessories

Leggio modulare per CQE

Modular desk for CQE cabinet



- Realizzato in lamiera d'acciaio sp. 15/10 verniciato RAL 7035 bucciato.
- Portella in lamiera d'acciaio sp. 20/10 verniciata RAL 7035 bucciato.
- Possibilità di impiego sia in presenza di altre portine modulari, sia fissato direttamente alla porta di un armadio.

- Made of 15/10 thick steel sheet painted textured RAL 7035.
- Cover made of 20/10 steel painted textured RAL 7035.
- May be used both in combination with other modular doors or applied directly to the enclosure door.

H 170

CODICE CODE	LARGHEZZA (mm) WIDTH (mm)	DIMENSIONI, MM DIMENSIONS, MM	
		PROFONDITÀ (mm) DEPTH (mm)	LARGHEZZA ELEMENTO (mm) ELEMENT WIDTH (mm)
R5LE600	600	400	500
R5LE800	800		700
R5LE1000	1000		900
R5LE1200	1200		1100

Tasca portaschemi in plastica

Plastic pocket for wiring diagrams



- Realizzate in plastica. Colore RAL 7035.
- La versione in plastica è universale. (Fissaggio mediante biadesivo)

- Plastic version. Color: RAL 7035.
- The plastic version is universal (attachable by double-sided tape).

H 220

CODICE CODE	PROFONDITÀ (mm) DEPTH (mm)	DIMENSIONI, MM DIMENSIONS, MM	
		LARGHEZZA ELEMENTO (mm) ELEMENT WIDTH (mm)	
RPA32	30	230	

■ Accessori armadi

Enclosure accessories

Tasche porta schemi in acciaio

Steel pocket for wiring diagrams



- Realizzate in metallo. Colore RAL 7035.
- Le versioni metalliche includono la viteria di fissaggio al telaio di rinforzo porta e sono da ordinare a seconda della larghezza dell'armadio.

- Metallic version. Color: RAL 7035.
- The metallic version is complete with fasteners for mounting to the reinforcement frame of the door and available in various dimensions depending on the enclosure's width.

H 240

CODICE CODE	LARGHEZZA (mm) WIDTH (mm)	DIMENSIONI, MM DIMENSIONS, MM		LARGHEZZA ELEMENTO (mm) ELEMENT WIDTH (mm)
		PROFONDITÀ (mm) DEPTH (mm)		
R5TE50	500			345
R5TE60	600			445
R5TE70	700	60		545
R5TE80	800			645
R5TE100	1000			845

■ Accessori armadi Enclosure accessories

Ripiano Porta Tastiera Tray for keyboard

- Realizzato in lamiera d'acciaio verniciato RAL 7035 bucciato.
 - Confezione da 1 pezzo completa di aste di sostegno e viteria per il montaggio.
- Larghezza Cod. R5PT800: 800-1000mm.**

- Made of steel sheet painted textured RAL 7035
 - Pack of 1 piece complete with support bars and fasteners.
- Cod. R5PT800 width: 800-1000mm.**

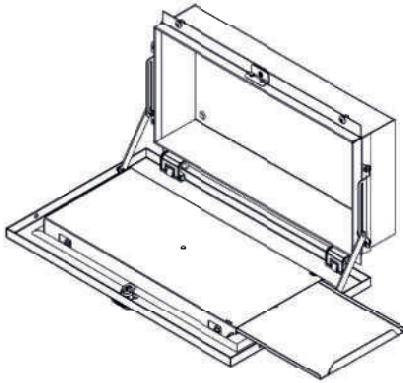

CODICE CODE	DIMENSIONI, MM DIMENSIONS, MM LARGHEZZA (mm) WIDTH (mm)
R5PT600	600
R5PT800	800 - 1000

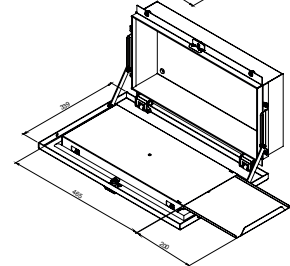
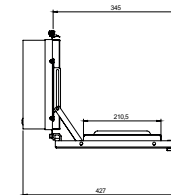
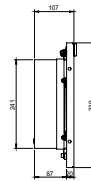
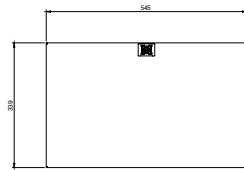
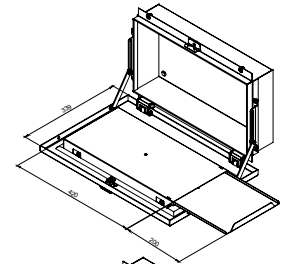
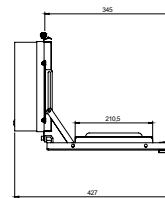
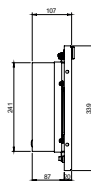
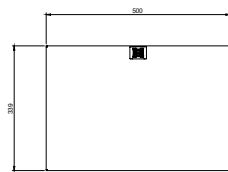

■ Accessori armadi Enclosure accessories

Profili laterali per CQE e CAE Side rails for CQE and CAE

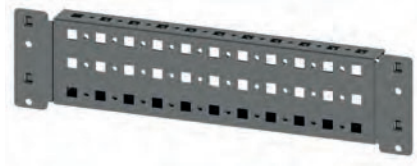

- Realizzati in lamiera d'acciaio zincata sendzimir sp. 15/10.
- Dotati di 5 file di fori a passo 25 mm per un sistema di fissaggio completo o parziale degli accessori.
- Utilizzati sulla profondità totale degli armadi.
- Il bloccaggio avviene semplicemente agganciando il profilo alla struttura ed assicurandolo alla stessa tramite viti autofilettanti.
- Confezione da 4 pezzi completa di viteria per il montaggio.

- Made of 15/10 thick Sendzimir galvanized steel.
- Provided with 5 rows of holes with 25 mm pitch allowing a total or a partial anchoring of the accessories
- Covers the total enclosure depth.
- To fix the rail to a structure it is sufficient to secure it with self-tapping screws.
- Pack of 4 pieces complete with accessories and screws for assembly.

CODICE CODE	DIMENSIONI, MM DIMENSIONS, MM		CARICO MAX MAX LOAD
	LARGHEZZA (mm) WIDTH (mm)		
RZPDL400	400		210
RZPDL500	500		200
RZPDL600	600		170
RZPDL800	800		140
RZPDL1000	1000		120
RZPDL1200	1200		120

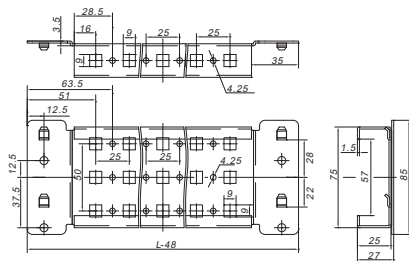

■ Accessori armadi

Enclosure accessories

Profili verticali per CQE e CAE

Vertical rails for CQE and CAE



- Realizzati in lamiera d'acciaio zincata sp. 15/10.
- Dotati di 5 file di fori a passo 25 mm per un sistema di fissaggio completo o parziale degli accessori.
- Fissati verticalmente alla struttura e posizionati in profondità a passo 25 mm.
- Confezione da 2 pezzi completa di viteria per il montaggio.
- Carico massimo profili montati in coppia: 180 Kg.
- Made of 15/10 thick galvanized steel.
- Provided with 5 rows of holes with 25 mm pitch allowing a total or a partial accessories anchoring.
- To be mounted vertically onto the structure and shifted inwards with 25 mm pitch.
- Pack of 2 pieces complete with accessories and screws for assembly.
- Max. load per pair of rails: 180 kg.

H 1400

CODICE
CODE

RZPDV14

H 1600

CODICE
CODE

RZPDV16

H 1800

CODICE
CODE

RZPDV18

H 2000

CODICE
CODE

RZPDV20

H 2200

CODICE
CODE

RZPDV22

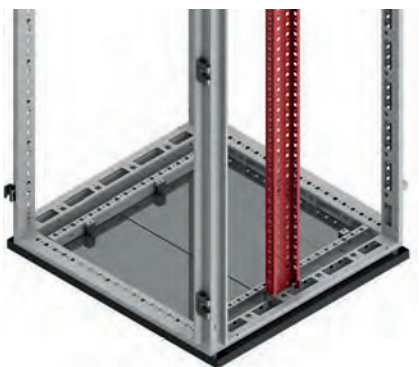
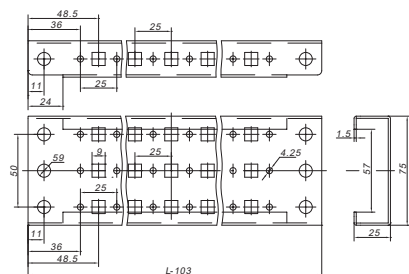

■ Accessori armadi

Enclosure accessories

Profili frontali per CQE e CAE

Front rails for CQE and CAE

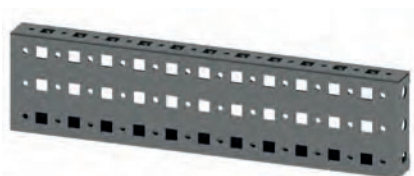

- Realizzati in lamiera d'acciaio zincata sp. 15/10.
- Dotati di 5 file di fori a passo 25 mm per un sistema di fissaggio completo o parziale degli accessori.
- Il fissaggio può avvenire direttamente sulla parte frontale della struttura oppure in profondità a passo 25mm utilizzando come supporto laterale di fissaggio dei profili laterali (cod. RZPDL).
- Confezione da 4 pezzi completa di viteria per il montaggio.
- Made of 15/10 thick galvanized steel.
- Provided with 5 rows of holes with 25 mm pitch allowing a total or a partial accessories anchoring.
- May be mounted directly to the frontal part of the enclosure or inwards with 25 mm pitch using side rails (RZPDL) as a support for mounting.
- Pack of 4 pieces complete with accessories and screws for assembly.

CODICE CODE	DIMENSIONI, MM DIMENSIONS, MM		CARICO MAX MAX LOAD
	LARGHEZZA (mm) WIDTH (mm)		
RZPDF400	400		210
RZPDF600	600		200
RZPDF800	800		170
RZPDF1000	1000		140
RZPDF1200	1200		120
RZPDF1400	1400		110
RZPDF1600	1600		100

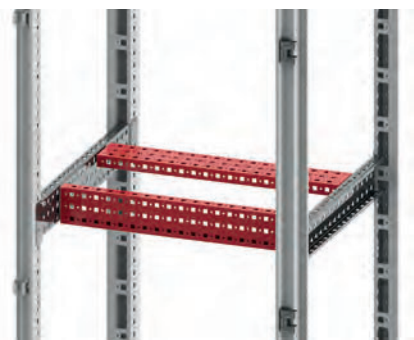
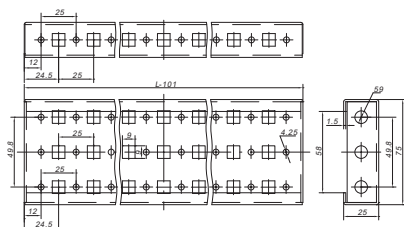

■ Accessori armadi

Enclosure accessories

Traversa laterale forata H30 mm per CQE e CAE

H30 Perforated side rail for CQE and CAE



- Realizzata in lamiera d'acciaio zincata sp. 15/10.
- Il profilo è dotato di una fila di fori a passo 25 mm e viene utilizzato sulla profondità degli armadi.
- Viene fissata semplicemente agganciandola alla struttura e successivamente fissandola alla medesima tramite viti autofilettanti.
- Confezione da 4 pezzi completa di viteria per il montaggio.

- Made of 15/10 thick galvanized steel.
- Provided with a row of holes with 25 mm pitch and covers the total enclosure depth.
- To fix the rail to a structure it is sufficient to secure it with self-tapping screws.
- Pack of 4 pieces complete with accessories and screws for assembly.

CODICE CODE	LARGHEZZA (mm) WIDTH (mm)	DIMENSIONI, MM	CARICO MAX MAX LOAD
		DIMENSIONS, MM	
RZTLE400	400		110
RZTLE500	500		90
RZTLE600	600		80
RZTLE800	800		60
RZTLE1000	1000		50
RZTLE1200	1200		40

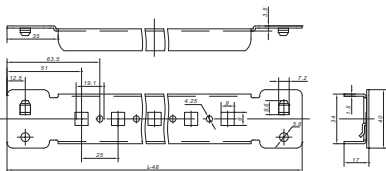

■ Accessori armadi

Enclosure accessories

Traversa laterale forata interna H 30 mm per CQE

H30 Internal perforated side rail for CQE



- Realizzata in lamiera d'acciaio zincata sp. 15/10.
- Il profilo è dotato di una fila di fori a passo 25 mm.
- Deve essere utilizzato in presenza dei seguenti articoli: porte interne (cod. R5PIE); montanti rack (cod. R5MRE e R5MRCE).
- Confezione da 4 pezzi completa di viteria per il montaggio.
- Made of 15/10 thick galvanized steel.
- Provided with a row of holes with 25 mm pitch.
- To be used if the following items are installed: internal doors (code R5PIE); rack uprights (code R5MRE and R5MRCE).
- Pack of 4 pieces complete with accessories and screws for assembly.

CODICE CODE	LARGHEZZA (mm) WIDTH (mm)	DIMENSIONI, MM	CARICO MAX MAX LOAD
		DIMENSIONS, MM	
RZPLE400	400		110
RZPLE500	500		90
RZPLE600	600		80
RZPLE800	800		60
RZPLE1000	1000		50

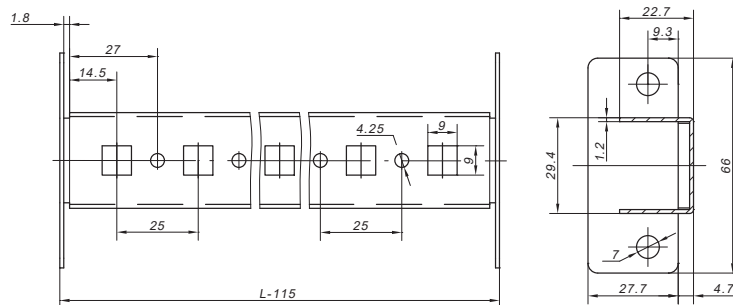

■ Accessori armadi

Enclosure accessories

Traversa frontale H 30 mm per CQE e CAE

H30 Front perforated rail for CQE and CAE



- Realizzata in lamiera d'acciaio zincata sp. 15/10.
- Profilo dotato di 3 file di fori a passo 25 mm.
- Si possono utilizzare fissandole direttamente sulla parte frontale della struttura oppure in profondità a passo 25 mm utilizzando come supporto le traverse laterali (cod. RZTLE).
- Confezione da 4 pezzi completa di viteria per il montaggio.

- Made of 15/10 thick galvanized steel.
- Provided with 3 rows of holes with 25 mm pitch.
- May be mounted directly to the frontal part of the enclosure or inwards with 25 mm pitch using side rails (cod. RZTLE) as a support for mounting.
- Pack of 4 pieces complete with accessories and screws for assembly.

CODICE CODE	LARGHEZZA (mm) WIDTH (mm)	DIMENSIONI, MM	CARICO MAX MAX LOAD
		DIMENSIONS, MM	
RZTFE400	400		100
RZTFE600	600		70
RZTFE800	800		65
RZTFE1000	1000		55
RZTFE1200	1200		50
RZTFE1400	1400		40
RZTFE1600	1600		35

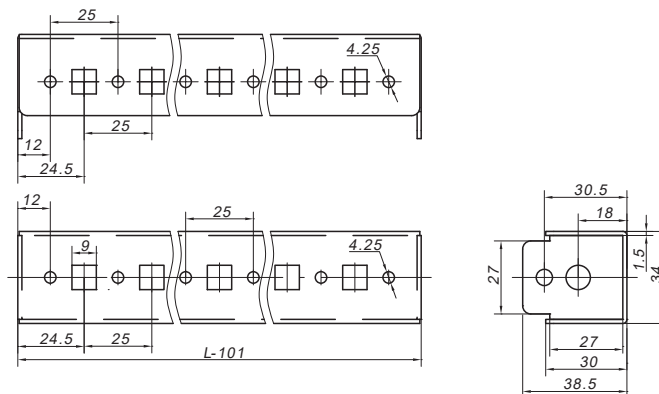

■ Accessori armadi

Enclosure accessories

Profilo ancoraggio cavi per CQE e CAE

Cable tie-down profile for CQE and CAE



- Realizzato in lamiera d'acciaio zincata sp. 20/10.
- Permette l'ancoraggio dei cavi tramite fascette e/o altri sistemi di bloccaggio.
- Regolabile in profondità con passo 25 mm.
- Confezione da 2 pezzi completa di viteria per il montaggio.

- Made of 20/10 thick galvanized steel.
- Allows cables to be anchored using cable ties and/or other locking systems.
- May be shifted inwards with 25 mm pitch.
- Pack of 2 pieces, complete with accessories and screws for assembly.

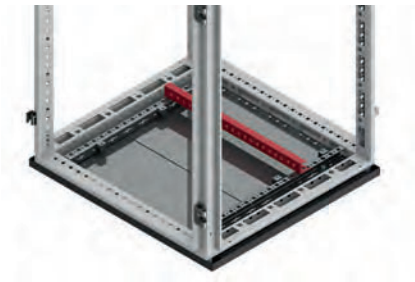

CODICE CODE	DIMENSIONI, MM DIMENSIONS, MM LARGHEZZA (mm) WIDTH (mm)
RZPAC40	400
RZPAC60	600
RZPAC80	800
RZPAC100	1000
RZPAC120	1200
RZPAC140	1400
RZPAC160	1600

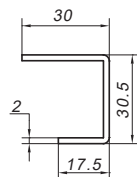
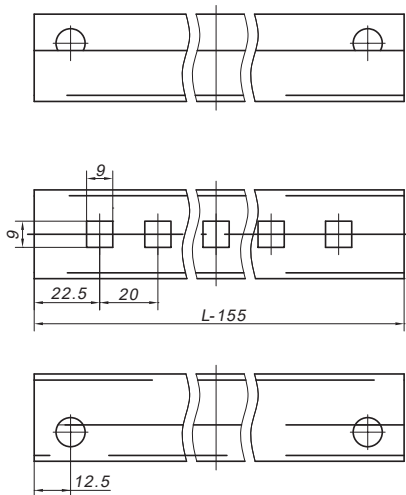

■ Accessori armadi

Enclosure accessories

Traversa porta trasformatore per CQE e CAE

Transformer support cross rail for CQE and CAE

- Realizzati in lamiera d'acciaio zincata sp. 30/10.
- Coppia di supporti in lamiera zincata pressopiegata con asole di fissaggio.
- Confezione da 2 pezzi completa di viteria per il montaggio.

Carico ottenibile mediante l'utilizzo di 2 profili RZPDL montati sulla profondità dell'armadio sotto le traverse RZTTE1200, RZTTE1400 e RZTTE1600.

- Made of 30/10 thick galvanized steel.
- A pair of supports of press-formed steel sheet with mounting holes.
- Pack of 2 pieces, complete with accessories and screws for assembly.

Load achivable by using 2 RZPDL profiles mounted on the depth of the cabinet under the RZTTE1200, RZTTE1400 e RZTTE1600 codes.

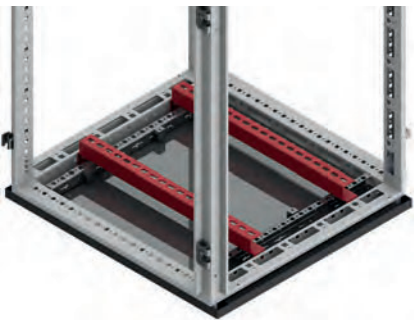

CODICE CODE	LARGHEZZA (mm) WIDTH (mm)	DIMENSIONI, MM	CARICO MAX MAX LOAD
		DIMENSIONS, MM	
RZTTE600	600		180
RZTTE800	800		150
RZTTE1000	1000		100
RZTTE1200	1200		
RZTTE1400	1400		150
RZTTE1600	1600		

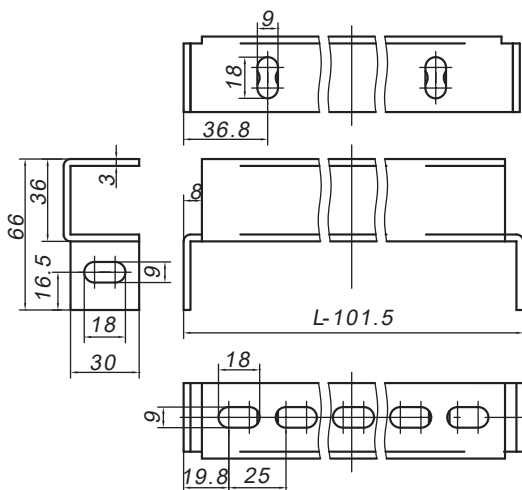

■ Accessori armadi

Enclosure accessories

Telaio rack 19" totale, larghezza 800 mm

Full 19" rack, width 800 mm

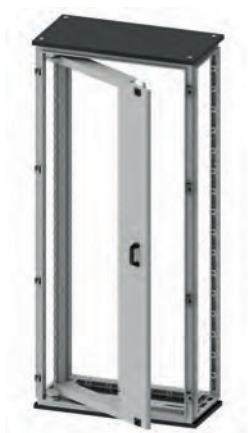

- Realizzato in lamiera d'acciaio sp. 15/10 con traverse orizzontali tubolari sp. 20/10.
- Verniciato RAL 7035 bucciato.
- Due chiusure complete di inserto tipo aletta doppio pettine Ø 3 mm.
- Apertura telaio 180°.
- Completo di accessori per il montaggio.
- Profondità massima del cassetto installabile: 420 mm.
- Distanza telaio-porta: 80 mm.
- Carico massimo Kg 120
- Made of 15/10 thick steel sheet with 20/10 thick horizontal tubular cross rails.
- Painted textured RAL 7035.
- Two locking elements with a Ø3 mm double-bit lock insert.
- 180° rack opening.
- Complete with mounting accessories.
- Max. installable drawer depth: 420 mm.
- Rack to door distance: 80 mm.
- Max. load: 120 kg.

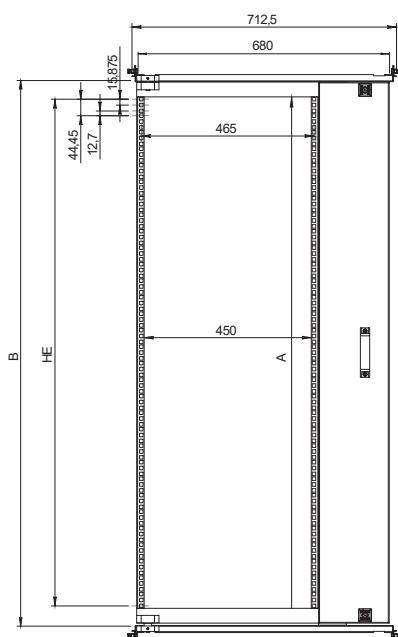

H 1600

CODICE CODE	LARGHEZZA (mm) WIDTH (mm)	DIMENSIONI, MM DIMENSIONS, MM		HE HE
		A A	B B	
R5TIE1680	800	1378	1458	31

H 1800

CODICE CODE	LARGHEZZA (mm) WIDTH (mm)	DIMENSIONI, MM DIMENSIONS, MM		HE HE
		A A	B B	
R5TIE1880	800	1578	1658	35

H 2000

CODICE CODE	LARGHEZZA (mm) WIDTH (mm)	DIMENSIONI, MM DIMENSIONS, MM		HE HE
		A A	B B	
R5TIE2080	800	1778	1858	40

H 2200

CODICE CODE	LARGHEZZA (mm) WIDTH (mm)	DIMENSIONI, MM DIMENSIONS, MM		HE HE
		A A	B B	
R5TIE2280	800	1978	2058	44

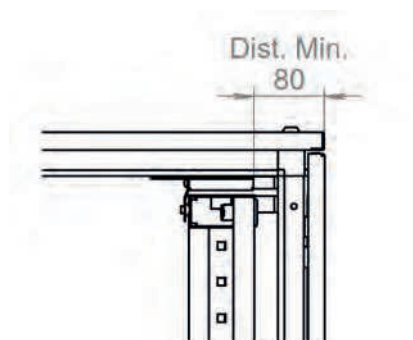

■ Accessori armadi

Enclosure accessories

Telaio rack 19" totale, larghezza 600 mm

Full 19" rack, width 600 mm



- Realizzato in lamiera d'acciaio sp. 15/10 con traverse orizzontali tubolari sp. 20/10.
 - Verniciato RAL 7035 bucciato.
 - Due chiusure complete di inserto tipo aletta doppio pettine Ø 3 mm.
 - Apertura telaio 130°.
 - Completo di accessori per il montaggio.
 - Profondità massima del cassetto installabile: 185 mm.
 - Distanza telaio-porta: 60 mm.
 - Carico massimo Kg 110
- Made of 15/10 thick steel sheet with 20/10 thick horizontal tubular cross rails.
 - Painted textured RAL 7035.
 - Two locking elements with a Ø3 mm double-bit lock insert.
 - 130° rack opening.
 - Complete with mounting accessories.
 - Max. installable drawer depth: 185 mm.
 - Rack to door distance: 60 mm.
 - Max. load: 110kg.

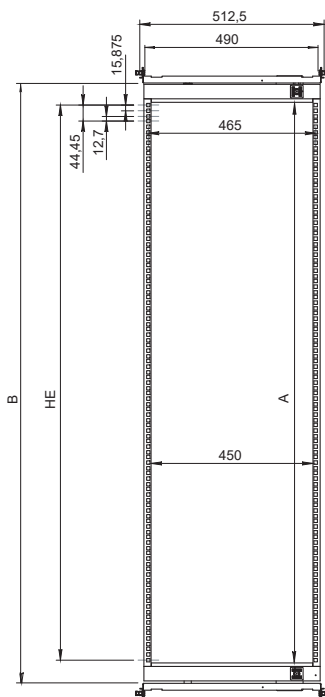

H 1600

CODICE CODE	LARGHEZZA (mm) WIDTH (mm)	DIMENSIONI, MM DIMENSIONS, MM		HE HE
		A A	B B	
R5TIE1660	600	1378	1458	31

H 1800

CODICE CODE	LARGHEZZA (mm) WIDTH (mm)	DIMENSIONI, MM DIMENSIONS, MM		HE HE
		A A	B B	
R5TIE1860	600	1578	1658	35

H 2000

CODICE CODE	LARGHEZZA (mm) WIDTH (mm)	DIMENSIONI, MM DIMENSIONS, MM		HE HE
		A A	B B	
R5TIE2060	600	1778	1858	40

H 2200

CODICE CODE	LARGHEZZA (mm) WIDTH (mm)	DIMENSIONI, MM DIMENSIONS, MM		HE HE
		A A	B B	
R5TIE2260	600	1978	2058	44

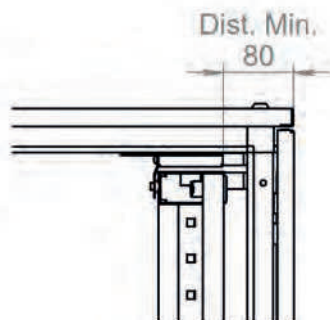

■ Accessori armadi

Enclosure accessories

Telaio rack 19" totale centrato, larghezza 800 mm

Full centered 19" rack, width 800mm



- Realizzato in lamiera d'acciaio sp. 15/10 con traverse orizzontali tubolari sp. 20/10.
 - Verniciato RAL 7035 bucciato.
 - Due chiusure complete di inserto tipo aletta doppio pettine Ø 3 mm.
 - Apertura telaio 180°.
 - Completo di accessori per il montaggio.
 - Profondità massima del cassetto installabile: 320 mm.
 - Distanza telaio-porta: 80 mm.
 - Carico massimo Kg 120
- Made of 15/10 thick steel sheet with 20/10 thick horizontal tubular cross rails.
 - Painted textured RAL 7035.
 - Two locking elements with a Ø3 mm double-bit lock insert.
 - 180° rack opening.
 - Complete with mounting accessories.
 - Max. installable drawer depth: 320 mm.
 - Rack to door distance: 80 mm.
 - Max. load: 120 kg.

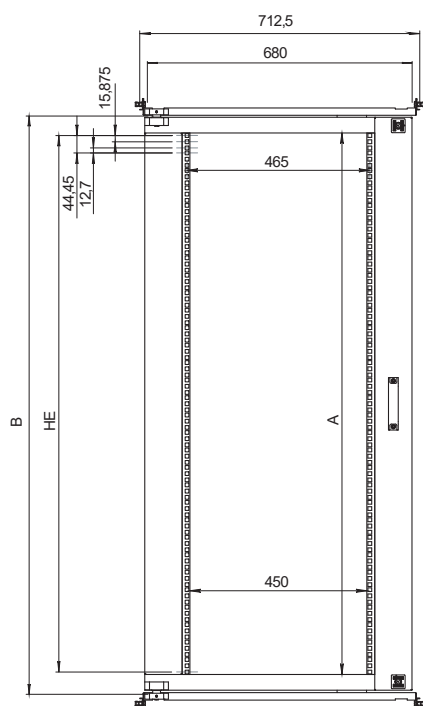

H 1600

CODICE CODE	LARGHEZZA (mm) WIDTH (mm)	DIMENSIONI, MM DIMENSIONS, MM		HE HE
		A A	B B	
R5TIEC1680	800	1378	1458	31

H 1800

CODICE CODE	LARGHEZZA (mm) WIDTH (mm)	DIMENSIONI, MM DIMENSIONS, MM		HE HE
		A A	B B	
R5TIEC1880	800	1578	1658	35

H 2000

CODICE CODE	LARGHEZZA (mm) WIDTH (mm)	DIMENSIONI, MM DIMENSIONS, MM		HE HE
		A A	B B	
R5TIEC2080	800	1778	1858	40

H 2200

CODICE CODE	LARGHEZZA (mm) WIDTH (mm)	DIMENSIONI, MM DIMENSIONS, MM		HE HE
		A A	B B	
R5TIEC2280	800	1978	2058	44

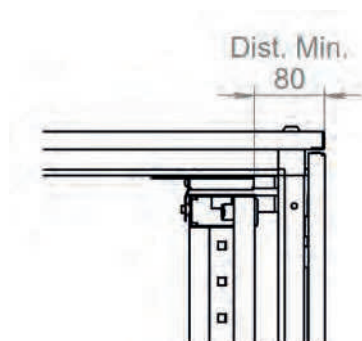

■ Accessori armadi

Enclosure accessories

Telaio rack 19" totale, larghezza 1000 mm

Full 19" rack, width 1000 mm



- Realizzato in lamiera d'acciaio sp. 15/10 con traverse orizzontali tubolari sp. 20/10.
- Verniciato RAL 7035 bucciato.
- Due chiusure complete di inserto tipo aletta doppio pettine Ø 3 mm.
- Apertura telaio 180°.
- Completo di accessori per il montaggio.
- Profondità massima del cassetto installabile: 530 mm.
- Distanza telaio-porta: 80 mm.
- Carico massimo Kg 100
- Made of 15/10 thick steel sheet with 20/10 thick horizontal tubular cross rails.
- Painted textured RAL 7035.
- Two locking elements with a Ø3 mm double-bit lock insert.
- 180° rack opening.
- Complete with mounting accessories.
- Max. installable drawer depth: 530 mm.
- Rack to door distance: 80 mm.
- Max. load: 100 kg.

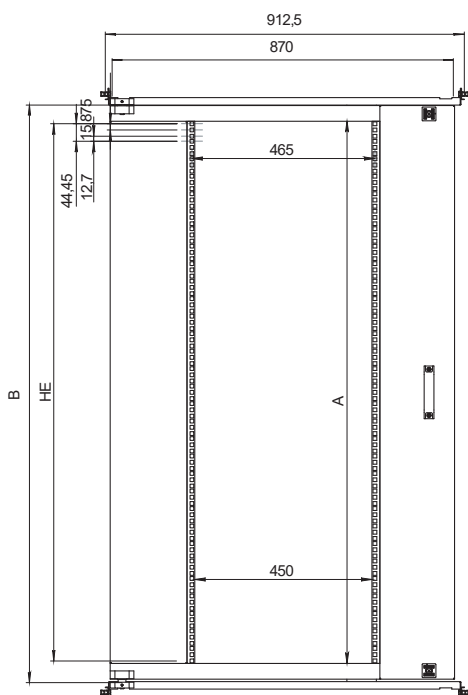

H 1600

CODICE CODE	LARGHEZZA (mm) WIDTH (mm)	DIMENSIONI, MM DIMENSIONS, MM		HE
		A	B	
R5TIE16100	1000	1378	1458	31

H 1800

CODICE CODE	LARGHEZZA (mm) WIDTH (mm)	DIMENSIONI, MM DIMENSIONS, MM		HE
		A	B	
R5TIE18100	1000	1578	1658	35

H 2000

CODICE CODE	LARGHEZZA (mm) WIDTH (mm)	DIMENSIONI, MM DIMENSIONS, MM		HE
		A	B	
R5TIE20100	1000	1778	1858	40

H 2200

CODICE CODE	LARGHEZZA (mm) WIDTH (mm)	DIMENSIONI, MM DIMENSIONS, MM		HE
		A	B	
R5TIE22100	1000	1978	2058	44

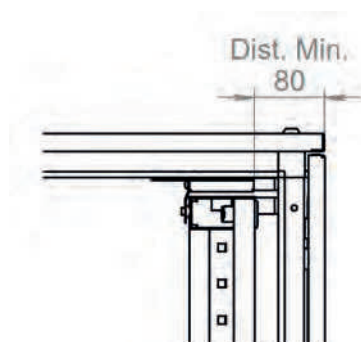

■ Accessori armadi Enclosure accessories

Arresto telaio rack Rack arrester



- Realizzato in lamiera d'acciaio zincata sendzimir.
- Studiato per limitarne l'apertura a 90° o a circa 130°.
- Confezione da 1 pezzo completa di accessori per il montaggio.
- Made of Sendzimir galvanized steel.
- Designed to limit the rack opening to 90° or 130° approximately.
- Pack of 1 piece complete with mounting accessories.

CODICE
CODE

RZAE03

■ Accessori armadi

Enclosure accessories

Telaio rack 19" parziale, larghezza 800 mm

Partial 19" rack, width 800 mm



- Realizzato in lamiera d'acciaio sp. 15/10 con traverse orizzontali tubolari sp. 20/10.
- Verniciato RAL 7035 bucciato.
- Due chiusure complete di inserto tipo aletta doppio pettine Ø 3 mm.
- Apertura telaio 180°.
- Completo di accessori per il montaggio.
- Profondità massima del cassetto installabile: 420 mm.
- Distanza telaio-porta: 80 mm.
- Per il fissaggio del telaio rack parziale aggiungere all'ordine una confezione di profili laterali (cod. RZPDL) in funzione della profondità dell'armadio.
- Carico massimo: 3 Kg per unità.
- Made of 15/10 thick steel sheet with 20/10 thick horizontal tubular cross rails.
- Painted textured RAL 7035.
- Two locking elements with a Ø3 mm double-bit lock insert.
- 180° rack opening.
- Complete with mounting accessories.
- Max. installable drawer depth: 420 mm.
- Rack to door distance: 80 mm.
- To mount a partial rack it is necessary to use side rails (1 pack, code RZPDL) depending on the depth of the enclosure (to be ordered separately).
- Max. load: 3 kg per unit.

H 600

CODICE CODE	DIMENSIONI, MM DIMENSIONS, MM			
	A	B	C	HE
R5TIEP6	270	350	432	6

H 900

CODICE CODE	DIMENSIONI, MM DIMENSIONS, MM			
	A	B	C	HE
R5TIEP9	403	483	565	9

H 1200

CODICE CODE	DIMENSIONI, MM DIMENSIONS, MM			
	A	B	C	HE
R5TIEP12	536,5	616,5	698,5	12

H 1600

CODICE CODE	DIMENSIONI, MM DIMENSIONS, MM			
	A	B	C	HE
R5TIEP16	713	793	875	16

H 1800

CODICE CODE	DIMENSIONI, MM DIMENSIONS, MM			
	A	B	C	HE
R5TIEP18	803	883	965	18

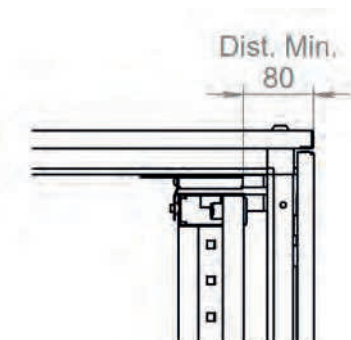
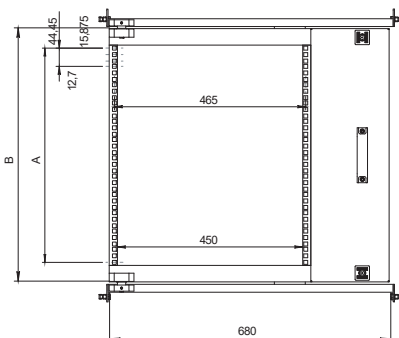

■ Accessori armadi

Enclosure accessories

Cornice rack 19" 19" rack frame



- Realizzata in lamiera d'acciaio sp. 15/10 verniciata RAL 7035 bucciato.
- Adatta per armadi con larghezza pari a 600mm.
- Completa di viteria per il montaggio.
- E' applicata in sostituzione di una porta R5CPE o di un retro R5CRE.

- Made of 15/10 thick steel sheet painted textured RAL 7035.
- Suitable for enclosures with the width of 600 mm.
- Complete with fasteners.
- To be installed instead of an R5CPE door or an R5CRE rear panel.

H 1400

CODICE CODE	DIMENSIONI, MM DIMENSIONS, MM		
	A A	B B	HE HE
R5CRK1460	1247,5	1355	28

H 1600

CODICE CODE	DIMENSIONI, MM DIMENSIONS, MM		
	A A	B B	HE HE
R5CRK1660	1470	1555	33

H 1800

CODICE CODE	DIMENSIONI, MM DIMENSIONS, MM		
	A A	B B	HE HE
R5CRK1860	1647,5	1755	37

H 2000

CODICE CODE	DIMENSIONI, MM DIMENSIONS, MM		
	A A	B B	HE HE
R5CRK2060	1870	1955	42

H 2200

CODICE CODE	DIMENSIONI, MM DIMENSIONS, MM		
	A A	B B	HE HE
R5CRK2260	2047,5	2155	46

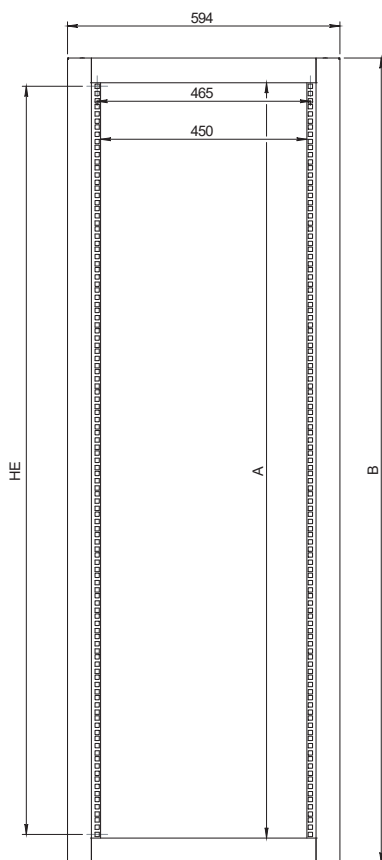

■ Accessori armadi Enclosure accessories

Montante rack 19" a "L" L-shapede upright for 19" rack



- Realizzato in lamiera d'acciaio verniciata RAL 7035 sp. 20/10.
- Confezione da 2 pezzi completa di accessori per il montaggio.
- Carico massimo: 150 Kg a coppia

- Made of 20/10 thick steel sheet painted RAL 7035.
- Pack of 2 pieces complete of mounting accessories.
- Max. load: 150 kg per pair.

H 1000

CODICE CODE	DIMENSIONI, MM DIMENSIONS, MM
	HE HE
R5MRE10	20

H 1200

CODICE CODE	DIMENSIONI, MM DIMENSIONS, MM
	HE HE
R5MRE12	24

H 1400

CODICE CODE	DIMENSIONI, MM DIMENSIONS, MM
	HE HE
R5MRE14	29

H 1600

CODICE CODE	DIMENSIONI, MM DIMENSIONS, MM
	HE HE
R5MRE16	33

H 1800

CODICE CODE	DIMENSIONI, MM DIMENSIONS, MM
	HE HE
R5MRE18	38

H 2000

CODICE CODE	DIMENSIONI, MM DIMENSIONS, MM
	HE HE
R5MRE20	42

H 2200

CODICE CODE	DIMENSIONI, MM DIMENSIONS, MM
	HE HE
R5MRE22	47

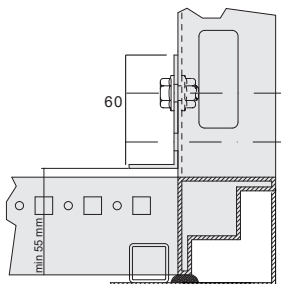
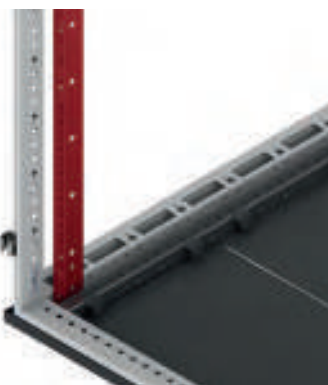

■ Accessori armadi Enclosure accessories

Montante rack 19" a "C" C-shaped upright for 19 inch rack He



- Realizzato in lamiera d'acciaio verniciata RAL 7035 sp. 20/10.
- Confezione da 2 pezzi completa di accessori per il montaggio.
- Carico massimo: 200 Kg a coppia.

- Made of 20/10 thick steel sheet painted RAL 7035.
- Pack of 2 pieces complete of mounting accessories.
- Max. load: 200 kg per pair.

H 1000

CODICE CODE	DIMENSIONI, MM DIMENSIONS, MM
	HE HE
R5MRCE10	20

H 1200

CODICE CODE	DIMENSIONI, MM DIMENSIONS, MM
	HE HE
R5MRCE12	24

H 1400

CODICE CODE	DIMENSIONI, MM DIMENSIONS, MM
	HE HE
R5MRCE14	29

H 1600

CODICE CODE	DIMENSIONI, MM DIMENSIONS, MM
	HE HE
R5MRCE16	33

H 1800

CODICE CODE	DIMENSIONI, MM DIMENSIONS, MM
	HE HE
R5MRCE18	38

H 2000

CODICE CODE	DIMENSIONI, MM DIMENSIONS, MM
	HE HE
R5MRCE20	42

H 2200

CODICE CODE	DIMENSIONI, MM DIMENSIONS, MM
	HE HE
R5MRCE22	47

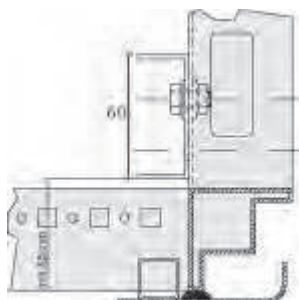
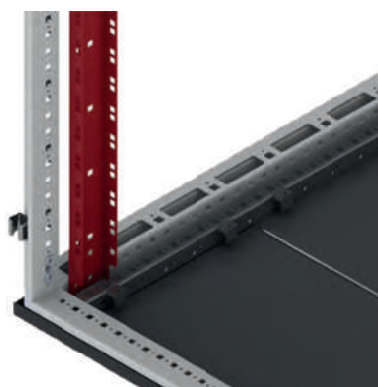

■ Accessori armadi Enclosure accessories

Squadrette di fissaggio montanti rack Mounting brackets for rack uprights



- Realizzate in lamiera d'acciaio zincata sendzimir sp. 30/10.
- Permettono il fissaggio dei nostri montanti R5MRE e R5MRCE a passo 19" in armadi larghi 800mm.
- Confezione da 4 pezzi completa di viteria necessaria al montaggio.

- Made of 30/10 thick Sendzimir galvanized steel.
- Allow to fix R5MRE and R5MRCE uprights with 19" pitch to 800 mm wide enclosures.
- Pack of 4 pieces complete with fasteners.

CODICE CODE	DIMENSIONI, MM DIMENSIONS, MM CONFEZIONI/PZ PACK/PCS
R5SFMR01	4

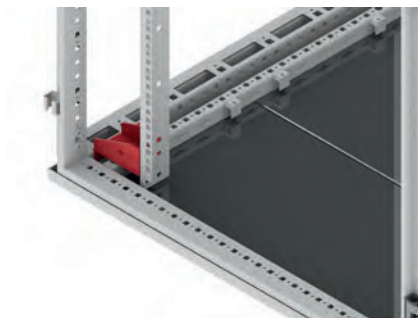

■ Accessori armadi

Enclosure accessories

Fasce verticali per montanti rack

Mounting brackets for rack uprights

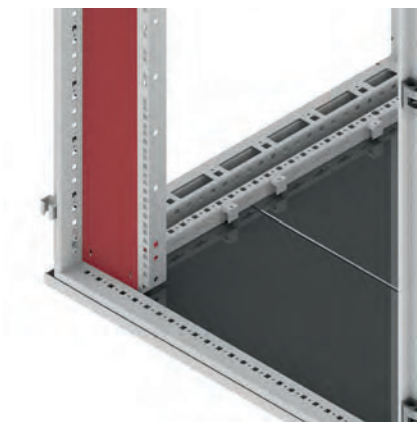

- Disponibili su ordinazione due fasce verticali di chiusura (cod R5FRV) larghe 100 mm per la chiusura dello spazio a lato dei montanti.
- Verniciate RAL 7035 bucciato.

- Available on order, two vertical closing strips (cod R5FRV) 100 mm wide suitable for closing the space at the side of the uprights.
- Painted textured RAL 7035.

H 1800

CODICE CODE	DIMENSIONI, MM DIMENSIONS, MM LARGHEZZA (mm) WIDTH (mm)
R5FRV18	800

H 2000

CODICE CODE	DIMENSIONI, MM DIMENSIONS, MM LARGHEZZA (mm) WIDTH (mm)
R5FRV20	800

H 2200

CODICE CODE	DIMENSIONI, MM DIMENSIONS, MM LARGHEZZA (mm) WIDTH (mm)
R5FRV22	800

■ Accessori armadi

Enclosure accessories

Pannello rack 19"

Rack plate 19"



- Realizzato in lamiera d'acciaio sp. 20/10 verniciata RAL 7035 bucciato.
- Confezione da 1 pezzo completa di accessori per il montaggio.

- Made of 20/10 thick steel sheet painted textured RAL 7035.
- Pack of 1 piece complete with mounting accessories.

CODICE CODE	DIMENSIONI, MM DIMENSIONS, MM		HE HE
	ALTEZZA ELEMENTO (mm) ELEMENT HEIGHT (mm)		
R5PRK1	43.6		1
R5PRK2	88		2
R5PRK3	132.5		3
R5PRK4	177		4
R5PRK5	221.5		5
R5PRK6	266		6
R5PRK7	310.5		7
R5PRK8	355		8
R5PRK9	399		9
R5PRK10	443.5		10
R5PRK11	488		11
R5PRK12	532.5		12

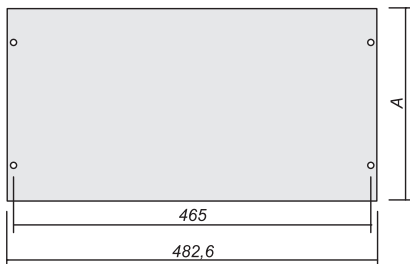

■ Accessori armadi Enclosure accessories

Sostegno Cassetto Rack Rack drawer support

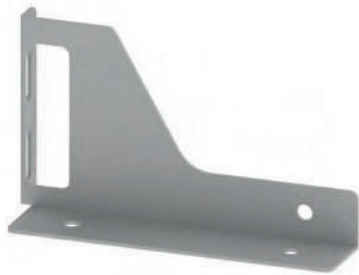

- Realizzato in lamiera d'acciaio sp. 15/10 verniciata RAL 7035 bucciato.
- Confezione da 1 coppia completa di accessori per il montaggio.

- Made of 15/10 thick steel sheet painted textured RAL 7035.
- Pack of 1 pair complete with mounting accessories.

CODICE CODE	DIMENSIONI, MM DIMENSIONS, MM CONFEZIONI/PZ PACK/PCS
R5SCRK01	2



Pannello di chiusura frontale da 19" forato con cava DIN 19" front panel with DIN cut-out

- Realizzato in lamiera d'acciaio sp. 15/10 verniciato RAL 7035 bucciato.
- Nella cava possono essere montati fino a 24 moduli DIN di altezza pari a 3 unità.
- Confezione da 1 pezzo completa di viteria per il montaggio e guida DIN.
- Da installare esclusivamente su montanti rack a "C" 19" R5MRCE.

- Made of 15/10 thick steel sheet painted textured RAL 7035.
- The cut-out may be used to accommodate up to 24 DIN modules with the height equal to 3 units.
- Pack of 1 piece complete with fasteners and a DIN guide.
- To be installed only on "C" rack uprights 19" R5MRCE.

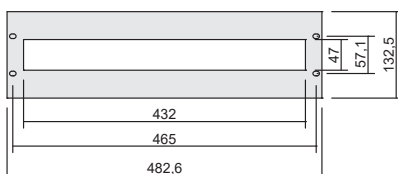

H 132.5

CODICE CODE
R5PCDF01

■ Accessori armadi

Enclosure accessories

Ripiano fisso per Rack 19"

Fixed tray for rack 19"



Materiale:

- lamiera d'acciaio sp. 15/10, verniciata RAL 7035.

Caratteristiche distintive:

- ingombro 2 unità;
- fissaggio anteriore;
- carico massimo statico – 25 kg.

La fornitura comprende:

- ripiano, accessori di montaggio.

Material:

- Made of 15/10 thick steel sheet, painted RAL 7035.

Characteristics:

- encumbrance, 2 units;
- front fixing;
- max constant load – 25 kg.

The supply includes:

- tray, mounting accessories.

H 88

CODICE CODE	LARGHEZZA (mm) WIDTH (mm)	DIMENSIONI, MM DIMENSIONS, MM	
		PROFONDITÀ (mm) DEPTH (mm)	HE HE
R5RFIT250	480	250	2
R5RFIT400	480	400	2

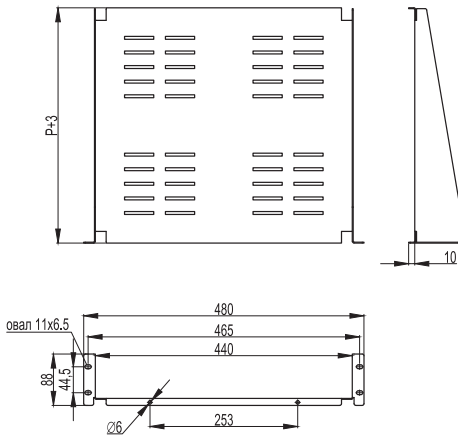

■ Accessori armadi

Enclosure accessories

Ripiano estraibile per Rack 19"

Sliding tray for Rack 19"



Materiale:

- lamiera d'acciaio sp. 15/10, verniciata RAL 7035.

Caratteristiche distintive:

- ingombro 2 unità;
- carico massimo statico – 60 kg.

La fornitura comprende:

- ripiano, accessori di montaggio.

Material:

- Made of 15/10 thick steel sheet, painted RAL 7035.

Characteristics:

- encumbrance, 2 units;
- max constant load – 60 kg.

The supply includes:

- tray, mounting accessories.

H 88

CODICE CODE	LARGHEZZA (mm) WIDTH (mm)	DIMENSIONI, MM DIMENSIONS, MM	
		PROFONDITÀ (mm) DEPTH (mm)	HE HE
R5REIT30	455	300	2

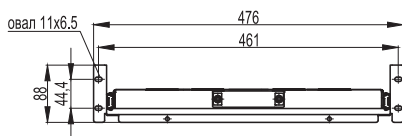
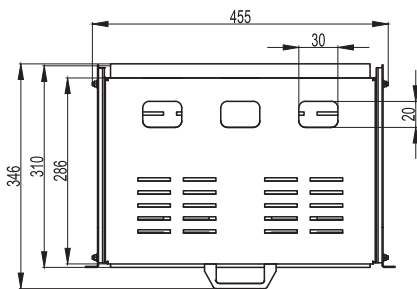

■ Accessori armadi Enclosure accessories

Traversa Sollevamento Lifting bar



Pressopiegate in esecuzione standard

- Realizzate in lamiera d'acciaio spessore 40/10 e verniciate RAL 7011.
- Non utilizzabile su configurazioni in batteria che prevedono armadi di larghezza 300mm.
- In fase d'ordine fornire il disegno della batteria per verifica.

Press-formed standard version

- Made of 40/10 thick steel sheet painted smooth RAL 7011.
- Cannot be used on battery configurations that include 300mm wide cabinets
- When ordering, provide the battery drawing for verification.

H 87

CODICE CODE	DIMENSIONI, MM DIMENSIONS, MM
	LARGHEZZA (mm) WIDTH (mm)
R1TSE01-080	800
R1TSE01-100	1000
R1TSE01-120	1200
R1TSE01-140	1400
R1TSE01-160	1600
R1TSE01-180	1800
R1TSE01-200	2000
R1TSE01-220	2200
R1TSE01-240	2400
R1TSE01-260	2600
R1TSE01-280	2800
R1TSE01-300	3000
R1TSE01-320	3200
R1TSE01-340	3400
R1TSE01-360	3600
R1TSE01-380	3800
R1TSE01-400	4000
R1TSE01-420	4200
R1TSE01-440	4400
R1TSE01-460	4600
R1TSE01-480	4800
R1TSE01-500	5000
R1TSE01-520	5200
R1TSE01-540	5400
R1TSE01-560	5600
R1TSE01-580	5800
R1TSE01-600	6000
R1TSE01-620	6200
R1TSE01-640	6400
R1TSE01-660	6600
R1TSE01-680	6800
R1TSE01-700	7000
R1TSE01-720	7200
R1TSE01-760	7600

■ Accessori armadi

Enclosure accessories

Traversa Sollevamento

Hot-rolled steel profile Lifting bar



- Dimensioni della sezione: 100 x 65 x 8.5 mm. Vendute a metro lineare.
- Verniciate RAL 7011 liscio.
- In fase di ordine fornire la configurazione della batteria di armadi per la foratura.

- Section dimensions: 100 x 65 x 8.5 mm. Sold by the linear meter.
- Painted smooth RAL 7011.
- When ordering, please provide the configuration of the enclosure battery system to ensure correct bar drilling.

CODICE
CODE

R1TSE03

Golfari di sollevamento per CQE e CAE

Lifting eyebolts for CQE and CAE cabinets



Golfari di sollevamento per CQE e CAE (M12).

Lifting eye bolts for CQE, DAE and CAE (M12). Enclosure type: CQE - CAE, 4 pieces.

CODICE CODE	PESO NETTO (kg) NET WEIGHT (kg)	DIMENSIONI, MM DIMENSIONS, MM	CONFEZIONI/PZ PACK/PCS
RZA33	0,76		4
RZA36	0,35		2

Squadrette di sollevamento per CQE

Lifting bracket for CQE cabinet



- Realizzate in lamiera d'acciaio sp. 50/10 zincate.
- Confezione da 2 squadrette completa di viteria per il fissaggio.

- Made of 50/10 thick galvanized steel.
- Pack of 2 pieces complete with fasteners.

CODICE
CODE

DIMENSIONI, MM
DIMENSIONS, MM
CONFEZIONI/PZ
PACK/PCS

RZTSE02

2

■ Accessori armadi

Enclosure accessories

Staffa di fissaggio a parete per CQE e CAE

Wall mounting bracket for CQE and CAE cabinets



- Realizzate in lamiera d'acciaio zincata sendzimir sp. 30/10.
- Confezione da 4 pezzi completa di accessori e viteria per il montaggio.

- Made of 30/10 thick Sendzimir galvanized steel.
- Pack of 4 pieces complete with fasteners and mounting accessories.

CODICE CODE	DIMENSIONI, MM DIMENSIONS, MM CONFEZIONI/PZ PACK/PCS
RZAE04	4

Squadrette di fissaggio universali

Universal mounting brackets

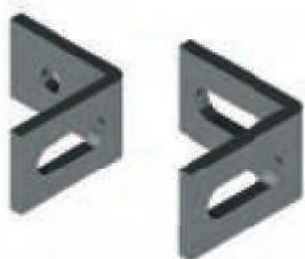

- Realizzate in lamiera d'acciaio sp. 40/10 zincata.
- Cod. RZA05 Asola-Asola 9x25.
- Cod. RZA06 Asola 9x25 - Filetto M8.

- Made of 40/10 thick galvanized steel.
- Cod. RZA05 Slot - Slot 9x25.
- Cod. RZA06 Slot 9x25 - Thread M8.

CODICE CODE	DIMENSIONI, MM DIMENSIONS, MM CONFEZIONI/PZ PACK/PCS
RZA05	10
RZA06	

Staffe di regolazione

Adjustable bracket



- Realizzato in lamiera d'acciaio sp. 20/10 zincata.
- Confezione da 2 pezzi.

- Made of 20/10 thick galvanized steel.
- Pack of 2 pieces.

CODICE CODE	DIMENSIONI, MM DIMENSIONS, MM RANGE RANGE
RZSRP01	75 - 125 mm
RZSRP02	150 - 200 mm

■ Accessori armadi

Enclosure accessories

Dispositivo antiribaltamento armadi

Anti-tipping device for cabinets

Frontali e laterali in lamiera d'acciaio spessore 15/10 verniciato RAL 7011 disponibili con altezza 100 mm, impediscono il ribaltamento dell'armadio.

Front and side plinth profile 15/10 thick steel sheet painted RAL 7011 available with height 100 mm, prevent the cabinet from tipping over.



CODICE CODE	DIMENSIONI, MM DIMENSIONS, MM
	LARGHEZZA (mm) WIDTH (mm)
R1ARIT600	600
R1ARIT800	800

■ Accessori armadi Enclosure accessories

Lampada fluorescente Fluorescent lamp

- 220 ÷ 240 V - 50 ÷ 60 Hz.
- Completa di staffa di fissaggio.
- Confezione da 1 pezzo.

- 220 ÷ 240 V - 50 ÷ 60 Hz.
- Complete with a mounting bracket.
- Pack of 1 piece.



CODICE CODE	DIMENSIONI, MM DIMENSIONS, MM	
	LUNGHEZZA LENGTH	POTENZA POWER
RALA08	350	8 W
RALA013	575	13 W

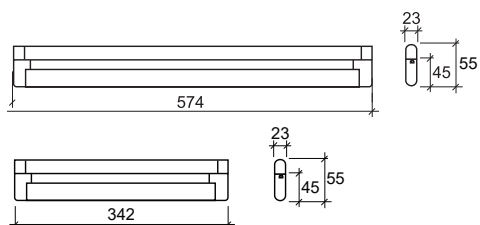

■ Accessori armadi

Enclosure accessories

Lampada Led

Led lamp



- 110 ÷ 240 V AC - 50 ÷ 60 Hz.
- Colore: bianco
- Confezione da 1 pezzo completa di viteria per il fissaggio e connettore maschio per il cablaggio.
- Temperatura - 40°C / + 70°C

- 110 ÷ 240 V AC - 50 ÷ 60 Hz.
- Color: white
- Pack of 1 piece complete of fasteners for fixing and male connector for wiring.
- Temperature - 40° / + 70°

CODICE CODE	POTENZA POWER	DIMENSIONI, MM DIMENSIONS, MM	LUNGHEZZA LENGTH
RALL06W240	6 W		572

Fissaggio magnetico per lampada a led

Magnetic fixing for led lamp

Accessorio opzionale per il fissaggio magnetico alla struttura della lampada a LED RALL06W240.

Accessory optional for magnetic mounting to the structure of LED RALL06W240 lamp.

CODICE CODE
RAKL10W

Lampada a led a fissaggio a vite

Screw fixing led lamp

Lampada a led a fissaggio a vite

Screw fixing led lamp



CODICE CODE	INTENSITÀ LUMINOSA LUMINOUS INTENSITY	DIMENSIONI, MM DIMENSIONS, MM	POTENZA POWER
		LUNGHEZZA ELEMENTO (mm) ELEMENT LENGTH (mm)	
RALL05WNM	5	356	5W

■ Accessori armadi

Enclosure accessories

Lampada a led interno quadro

Enclosure interior LED light



- Fissaggio magnetico.
- Omologazione UL.
- Accensione tramite sensore di prossimità.
- Cavo di alimentazione venduto a parte: codice RACCLL04W.
- Tensione di alimentazione 24 - 265 VAC/DC
- Magnetic fastening
- UL homologation
- Activation by proximity sensor
- Power cable, sold separately
- Power supply voltage 24 - 265 VAC/DC

CODICE CODE	LARGHEZZA (mm) WIDTH (mm)	POTENZA POWER	DIMENSIONI, MM DIMENSIONS, MM		AUTONOMIA AUTONOMY
			INTENSITÀ LUMINOSA LUMINOUS INTENSITY	TEMPERATURA COLORE TEMPERATURE	
RALL04WMS	-	4 W	400 Lm	6500K	5 min

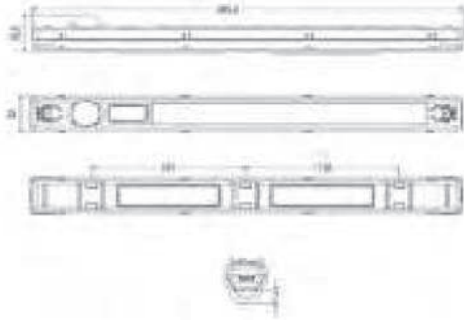

■ Accessori armadi Enclosure accessories

Micro interruttore Micro-switch



- Conforme alle normative IEC/EN 60947-5-1.
- Fine corsa 2NC (RAMC01) - Fine corsa 1NO+1NC (RAMC05).
- Confezione completa di staffa in lamiera zincata sendzimir e viteria necessaria al montaggio.

- Compliant to IEC/EN 60947-5-1.
- Limit switch 2NC (RAMC01) - Limit switch 1NO+1NC (RAMC05).
- Complete with a Sendzimir galvanized bracket and fasteners.

CODICE
CODE

RAMC01

RAMC05

Dispositivo lampeggiante trifase Three-phase flashing unit

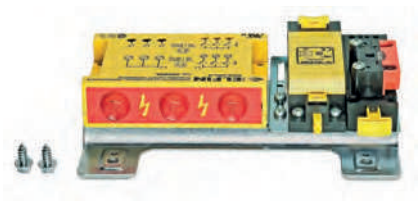

- Finecorsa tripolare cablato lampeggiante.
- Determina l'inserimento quando le porte dell'armadio sono aperte.

- Cabled three-phase flashing limit switch.
- Engaged when the enclosure doors are open.

CODICE
CODE

RAMC02

■ Accessori armadi

Enclosure accessories

Viti autofilettanti M 4.8x12

Self-tapping screws M 4.8x12



- Realizzate in acciaio zincato bianco.
- Confezione da 50 pezzi.
- Made of white galvanized steel.
- Pack of 50 pieces.

CODICE CODE	DIMENSIONI, MM DIMENSIONS, MM
RAA07	M4.8x12

Dadi Speciali

Special nuts



- Realizzati in lega di zinco pressofusa.
- Forniti di linguetta tranciabile.
- Consigliati nel posizionamento dei dadi e il serraggio delle viti in prossimità di fori difficilmente raggiungibili.
- Confezione da 50 pezzi.
- Made of press-formed zinc alloy.
- Provided with a detachable tab.
- Recommended when positioning nuts and tightening screws near hard-to-reach holes.
- Pack of 50 pieces.

CODICE CODE	DIMENSIONI, MM DIMENSIONS, MM
RAA51	M6
RAA52	M8

■ Accessori armadi

Enclosure accessories

Dado a gabbia

Cage nut



- Realizzati in lega di zinco pressofusa.
- Forniti di linguetta tranciabile.
- Consigliati nel posizionamento dei dadi e il serraggio delle viti in prossimità di fori difficilmente raggiungibili.
- Confezione da 50 pezzi.
- Made of press-formed zinc alloy.
- Provided with a detachable tab.
- Recommended when positioning nuts and tightening screws near hard-to-reach holes.
- Pack of 50 pieces.

CODICE CODE	CONFEZIONI/PZ PACK/PCS	DIMENSIONI, MM	FORO HOLE
		DIMENSIONS, MM	
RZG01			9 per M6
RZG02	50		12 per M6
RZG03			12 per M8

Vernice spray

Spray Paint



- Vernice acrilica.
- Contenuto: 400 ml.
- Confezione da 1 bomboletta.
- Acrylic paint.
- Capacity: 400 ml.
- Pack of 1 spray.

CODICE CODE	DIMENSIONI, MM
	FINITURA FINISHING
RAA21	RAL 7032
RAA24	RAL 7035
RAA54	RAL 7011

■ Accessori armadi

Enclosure accessories

Guarnizione Adesiva 8x3

Adhesive gasket 8x3



Guarnizione Adesiva 8x3.

Adhesive gasket 8x3.

CODICE CODE	DIMENSIONI, MM DIMENSIONS, MM LUNGHEZZA LENGTH
RAA56	6 mt

Kit Antisismico Light

Anti-seismic kit - Light



Kit antisismico light aggiuntivo per armadio modulare CQE. Confezione completa di zoccolo rigido in lamiera d'acciaio pressopiegata sp. 3,0 mm con possibilità di fissaggio al pavimento, staffe supplementari per il fissaggio del pannello di cablaggio, traverse centrali H. 75 mm, maniglia con serratura a chiave cifrata, perni per cerniera con seeger. H. 1400-2000

Additional light anti-seismic kit for CQE modular enclosure. Complete with rigid plinth made of 3.0 mm thick press-folded sheet steel with the possibility of fixing to the floor, additional brackets for fixing the mounting plate, centre side rails H. 75 mm, handle with encrypted key lock, hinge pins with seeger. H. 1400-2000

H 2000

CODICE CODE	LARGHEZZA (mm) WIDTH (mm)	DIMENSIONI, MM DIMENSIONS, MM PROFONDITÀ (mm) DEPTH (mm)	CARICO MAX MAX LOAD
RAKASL0086		600	
RAKASL0088	800	800	150

■ Accessori armadi Enclosure accessories

Kit Antisismico Medium Anti-seismic kit - Medium



Kit antisismico medium aggiuntivo per armadio modulare CQE. Confezione completa di zoccolo rigido in lamiera d'acciaio pressopiegata sp. 3,0 mm con possibilità di fissaggio al pavimento, staffe supplementari per il fissaggio del pannello di cablaggio, traverse centrali H. 75 mm, squadrette angolari di irrigidimento superiori e inferiori, maniglia con serratura a chiave cifrata, perni per cerniera con seeger. H. 1400-2000mm

Additional medium anti-seismic kit for CQE modular enclosure. Complete with rigid plinth made of 3.0 mm thick press-folded sheet steel with the possibility of fixing to the floor, additional brackets for fixing the mounting plate, centre side rails H. 75 mm, upper and lower stiffening angle brackets, handle with encrypted key lock, hinge pins with seeger.

H 2000

CODICE CODE	LARGHEZZA (mm) WIDTH (mm)	DIMENSIONI, MM DIMENSIONS, MM		CARICO MAX MAX LOAD
		PROFONDITÀ (mm) DEPTH (mm)		
RAKASM0086	800	600		250
RAKASM0088		800		

■ Accessori armadi Enclosure accessories

Kit Antisismico Strong Anti-seismic kit - Strong



Kit antisismico strong aggiuntivo per armadio modulare CQE. Confezione completa di zoccolo rigido in lamiera d'acciaio pressopiegata sp. 3,0 mm con possibilità di fissaggio al pavimento, staffe supplementari per il fissaggio del pannello di cablaggio, traverse centrali H. 75 mm, squadrette angolari di irrigidimento superiori e inferiori, tiranti laterali di irrigidimento con squadrette centrali, maniglia con serratura a chiave cifrata, perni per cerniera con seeger.

Additional strong anti-seismic kit for CQE modular enclosure. Complete with rigid plinth made of 3.0 mm thick press-folded sheet steel with the possibility of fixing to the floor, additional brackets for fixing the mounting plate, centre side rails H. 75 mm, upper and lower stiffening angle brackets, side stiffening rods with centre brackets, handle with encrypted key lock, hinge pins with seeger.

H 2000

CODICE CODE	LARGHEZZA (mm) WIDTH (mm)	DIMENSIONI, MM DIMENSIONS, MM		CARICO MAX MAX LOAD
		PROFONDITÀ (mm) DEPTH (mm)		
RAKASS2086	800	600		500
RAKASS2088		800		

■ Modularità esterna per armadi

External modularity for enclosures

Per armadi CQE

For CQE enclosures



I sistemi modulari per la distribuzione sono stati ricavati direttamente dagli armadi serie **CQE**. Essi consentono, con l'applicazione di componenti particolarmente studiati, l'allestimento di quadri di distribuzione di energia in bassa tensione.

Le strutture degli armadi possono essere configurate in quadri con porte modulari esterne cieche e sfinate a celle separate e con pannelli di cablaggio regolabili in profondità.

La zona anteriore è riservata agli interruttori, alle misure e ai servizi ausiliari. La zona posteriore, invece, è riservata alla connessione degli interruttori alle sbarre di derivazione. E' possibile installare il sistema sbarre nella colonna laterale (armadio risalita cavi con accesso frontale) oppure nella zona posteriore dell'armadio, avendo notevoli vantaggi nella realizzazione delle connessioni.

Modular systems for distribution have been conceived on the basis of **CQE** series. Using carefully studied components they allow arranging BT distribution boards.

Enclosures may be configured of panels with modular external blank or cutout doors in the form of separate cells and with mounting panels adjustable in depth.

The frontal area is purposed for switches, measurement instruments and auxiliary units. While the rear area is occupied by connections of the switches to distribution buses. It is possible to install the bus system into a side column (cable chamber with front access) or to the rear enclosure area obtaining significant advantages in connection works.

Codici di lavorazione

Assembling codes



CODICE CODE	DESCRIZIONE DESCRIPTION
RLAPE22	Montaggio porte modulari Distribution doors mounting
RLACE22	Montaggio celle Cells mounting

■ Modularità esterna External modularity

Armadio con retro

CQE enclosure structure and rear panel



Telaio

struttura assemblata con profilo chiuso in acciaio zincato sp. 15/10 verniciato RAL 7035 bucciato.

Tetto e base

lamiera d'acciaio sp. 15/10 verniciati RAL 7011 bucciato, asportabili.

Fondo

lamiera d'acciaio zincato sp. 15/10 con ingresso cavi regolabile.

Retro

lamiera d'acciaio sp. 15/10 verniciato RAL 7035 bucciato e 8 punti di fissaggio alla struttura.

Composizione

telaio, tetto, base, fondo e retro.

Frame

Assembled structure with closed profile in 15/10 thick galvanized steel and painted RAL 7035, textured finish. 25mm vertical chasing on the whole structure allows a quick positioning of the modular doors and for drilling the mounting holes of the hinges and hooks.

Roof and base

Manufactured of 15/10 thick steel, painted textured RAL 7011, removable. Rear panel 15/10 thick steel, painted textured RAL7035 and 8 points of fastening to the structure.

Bottom

15/10 thick galvanized steel, adjustable cable gland.

Composition

Frame, roof, base, rear panel and bottom.



H 1800

CODICE CODE	LARGHEZZA (mm) WIDTH (mm)	DIMENSIONI, MM DIMENSIONS, MM	
		PROFONDITÀ (mm) DEPTH (mm)	
R5CQE1864R	600	400	
R5CQE1865R		500	
R5CQE1866R		600	
R5CQE1868R		800	
R5CQE1884R	800	400	
R5CQE1885R		500	
R5CQE1886R		600	
R5CQE1888R		800	

H 2000

CODICE CODE	LARGHEZZA (mm) WIDTH (mm)	DIMENSIONI, MM DIMENSIONS, MM	
		PROFONDITÀ (mm) DEPTH (mm)	
R5CQE2064R	600	400	
R5CQE2065R		500	
R5CQE2066R		600	
R5CQE2068R		800	
R5CQE2084R	800	400	
R5CQE2085R		500	
R5CQE2086R		600	
R5CQE2088R		800	

■ Modularità esterna External modularity

Armadio con retro

CQE enclosure structure and rear panel



H 2200

CODICE CODE	DIMENSIONI, MM DIMENSIONS, MM	
	LARGHEZZA (mm) WIDTH (mm)	PROFONDITÀ (mm) DEPTH (mm)
R5CQE2265R		500
R5CQE2266R	600	600
R5CQE2268R		800
R5CQE2285R		500
R5CQE2286R	800	600
R5CQE2288R		800

■ Modularità esterna External modularity

Pannelli di compensazione Blanking panel



Pannelli di compensazione obbligatori per allestimento fronte quadro. Altezza utile per allestimento = H armadio - 200 mm.

- Realizzati in lamiera d'acciaio sp. 15/10 verniciati RAL 7035 bucciato.
- Confezione da 2 pezzi completa di accessori per il montaggio.

Blanking panels are mandatory for front enclosure arrangement. Width usable for arrangement = H enclosure - 200 mm.

- Made of 15/10 thick steel sheet painted textured RAL 7035.
- Pack of 2 pieces complete with mounting accessories.

H 100

CODICE CODE	DIMENSIONI, MM DIMENSIONS, MM
	LARGHEZZA (mm) WIDTH (mm)
R5CPFE6100	600
R5CPFE8100	800

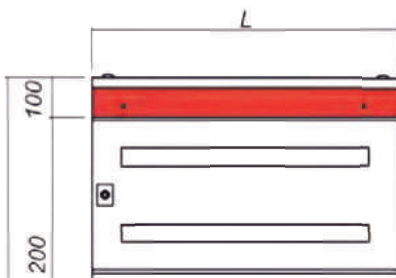

■ Modularità esterna External modularity

Traversa di battuta per porte modulari Modular door ledge

- Realizzata in lamiera d'acciaio sp. 15/10 verniciata RAL 7035 bucciato.
- Confezione da 1 pezzo completa di accessori per il montaggio.

- Made of 15/10 thick steel sheet, painted textured RAL 7035.
- Pack of 1 pieces complete with mounting accessories.



CODICE CODE	DIMENSIONI, MM DIMENSIONS, MM LARGHEZZA (mm) WIDTH (mm)
R5TOE60	600
R5TOE80	800



■ Modularità esterna External modularity

Pannello di cablaggio modulare Modular mounting plate



- Realizzato in lamiera zincata sendzimir 20/10.
- Regolabile in profondità.
- Completa di viteria per il fissaggio.
- Confezione 1 pezzo.

- Made of 20/10 thick Sendzimir galvanized steel.
- Adjustable in depth.
- Complete with fasteners.
- Pack of 1 piece.

H 200

CODICE CODE	DIMENSIONI, MM DIMENSIONS, MM	
	LARGHEZZA (mm) WIDTH (mm)	E
RZPCE6200	600	200
RZPCE8200	800	200

H 300

CODICE CODE	DIMENSIONI, MM DIMENSIONS, MM	
	LARGHEZZA (mm) WIDTH (mm)	E
RZPCE6300	600	300
RZPCE8300	800	300

H 400

CODICE CODE	DIMENSIONI, MM DIMENSIONS, MM	
	LARGHEZZA (mm) WIDTH (mm)	E
RZPCE6400	600	400
RZPCE8400	800	400

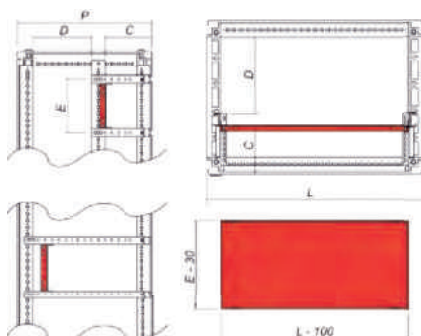

H 500

CODICE CODE	DIMENSIONI, MM DIMENSIONS, MM	
	LARGHEZZA (mm) WIDTH (mm)	E
RZPCE6500	600	500
RZPCE8500	800	500

H 600

CODICE CODE	DIMENSIONI, MM DIMENSIONS, MM	
	LARGHEZZA (mm) WIDTH (mm)	E
RZPCE6600	600	600
RZPCE8600	800	600

H 800

CODICE CODE	DIMENSIONI, MM DIMENSIONS, MM	
	LARGHEZZA (mm) WIDTH (mm)	E
RZPCE6800	600	800
RZPCE8800	800	800

H 900

CODICE CODE	DIMENSIONI, MM DIMENSIONS, MM	
	LARGHEZZA (mm) WIDTH (mm)	E
RZPCE6900	600	900
RZPCE8900	800	900

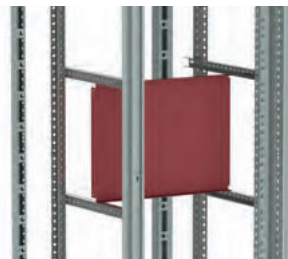

■ Modularità esterna External modularity

Pannello di cablaggio modulare Modular mounting plate



H 1000

CODICE CODE	DIMENSIONI, MM DIMENSIONS, MM	E E
	LARGHEZZA (mm) WIDTH (mm)	
RZPCE61000	600	1000
RZPCE81000	800	

■ Modularità esterna External modularity

Porta modulare cieca Modular blank door



- Realizzata in lamiera d'acciaio sp. 20/10 verniciata RAL 7035 bucciato.
- Completa di accessori per il montaggio.
- Confezione 1 pezzo.

- Made of 20/10 thick steel sheet, painted textured RAL 7035.
- Complete with mounting accessories.
- Pack of 1 piece.

H 200

CODICE CODE	DIMENSIONI, MM DIMENSIONS, MM	
	LARGHEZZA (mm) WIDTH (mm)	E
R5CPME6200	600	200
R5CPME8200	800	200

H 300

CODICE CODE	DIMENSIONI, MM DIMENSIONS, MM	
	LARGHEZZA (mm) WIDTH (mm)	E
R5CPME6300	600	300
R5CPME8300	800	300

H 400

CODICE CODE	DIMENSIONI, MM DIMENSIONS, MM	
	LARGHEZZA (mm) WIDTH (mm)	E
R5CPME6400	600	400
R5CPME8400	800	400

H 500

CODICE CODE	DIMENSIONI, MM DIMENSIONS, MM	
	LARGHEZZA (mm) WIDTH (mm)	E
R5CPME6500	600	500
R5CPME8500	800	500

H 600

CODICE CODE	DIMENSIONI, MM DIMENSIONS, MM	
	LARGHEZZA (mm) WIDTH (mm)	E
R5CPME6600	600	600
R5CPME8600	800	600

H 800

CODICE CODE	DIMENSIONI, MM DIMENSIONS, MM	
	LARGHEZZA (mm) WIDTH (mm)	E
R5CPME6800	600	800
R5CPME8800	800	800

H 900

CODICE CODE	DIMENSIONI, MM DIMENSIONS, MM	
	LARGHEZZA (mm) WIDTH (mm)	E
R5CPME6900	600	900
R5CPME8900	800	900

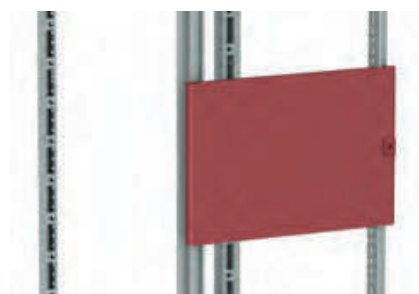
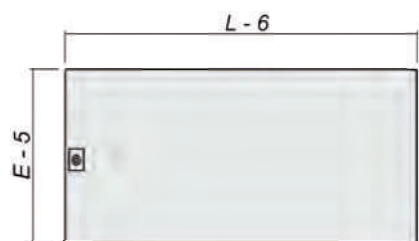

■ Modularità esterna External modularity

Porta modulare con cava DIN Modular door with DIN cut-out



- Realizzata in lamiera d'acciaio sp. 15/10 verniciata RAL 7035 bucciato.
- Confezione da 1 pezzo completa di accessori per il montaggio e guida DIN.

- Made of 15/10 thick steel sheet, painted textured RAL 7035.
- Pack of 1 pieces complete with mounting accessories and DIN guide.

H 200

CODICE CODE	LARGHEZZA (mm) WIDTH (mm)	DIMENSIONI, MM DIMENSIONS, MM	
		APERTURE OPENINGS	NUMERO MODULI MODULES NUMBER
R5CPME6201	600	1	26
R5CPME8201	800		36

H 400

CODICE CODE	LARGHEZZA (mm) WIDTH (mm)	DIMENSIONI, MM DIMENSIONS, MM	
		APERTURE OPENINGS	NUMERO MODULI MODULES NUMBER
R5CPME6401	600	2	26
R5CPME8401	800		36

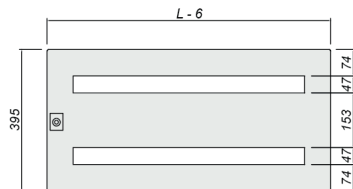
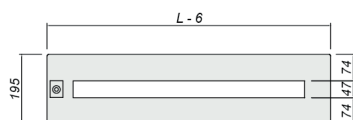

■ Modularità esterna External modularity

Porta modulare con finestra trasparente Modular door with glazed window

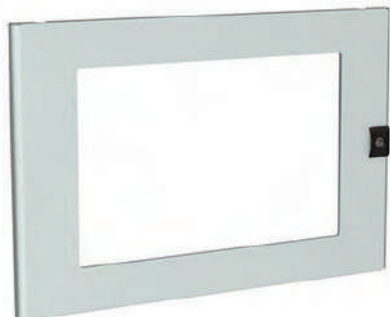

- Realizzata in lamiera d'acciaio sp. 20/10 verniciata RAL 7035 bucciato.
- Finestra trasparente protetta da vetro di sicurezza trasparente.
- Completa di accessori per il montaggio.
- Confezione 1 pezzo.

- Made of 20/10 thick steel sheet, painted textured RAL 7035.
- Clear window protected with transparent safety glass.
- Complete with mounting accessories.
- Pack of 1 piece.

H 400

CODICE CODE	DIMENSIONI, MM DIMENSIONS, MM	
	LARGHEZZA (mm) WIDTH (mm)	E
R5CPMTE6400	600	395
R5CPMTE8400	800	

H 600

CODICE CODE	DIMENSIONI, MM DIMENSIONS, MM	
	LARGHEZZA (mm) WIDTH (mm)	E
R5CPMTE6600	600	595
R5CPMTE8600	800	

H 800

CODICE CODE	DIMENSIONI, MM DIMENSIONS, MM	
	LARGHEZZA (mm) WIDTH (mm)	E
R5CPMTE6800	600	795
R5CPMTE8800	800	

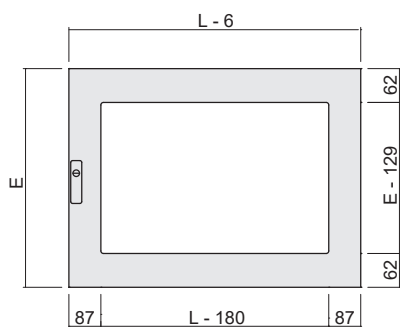

■ Modularità esterna External modularity

Porta modulare interna Internal modular door



- Realizzata in lamiera d'acciaio sp. 20/10 verniciata RAL 7035 bucciato.
- Distanza utile tra porta interna e porta esterna pari a 70 mm.
- Completa di accessori per il montaggio.
- Confezione 1 pezzo.
- Le porte modulari con finestra trasparente (art. R5CPMTE) sono solitamente utilizzate a protezione degli strumenti fissati sulla porta interna (art. R5CPMIE) nella parte superiore dell'armadio.
- Nella parte inferiore della struttura è possibile applicare altri componenti quali il leggio (art. R5LE) oppure altre portine modulari (art. R5CPME).

- Made of 20/10 thick steel sheet, painted textured RAL 7035.
- Usable distance between the internal and external door is equal to 70 mm.
- Complete with mounting accessories.
- Pack of 1 piece.
- Modular doors with clear window (code R5CPMTE) are commonly used to protect the instruments mounted on the internal door (code R5CPMIE) in the upper part of the enclosure.
- In the lower part of the enclosure other components may be installed, such as a shelf (code R5LE) or other modular doors (code R5CPME).

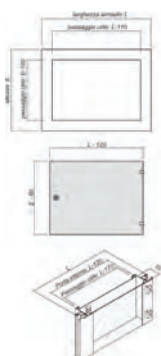

H 400

CODICE CODE	DIMENSIONI, MM DIMENSIONS, MM	
	LARGHEZZA (mm) WIDTH (mm)	E
R5CPMIE6400	600	400
R5CPMIE8400	800	400

H 600

CODICE CODE	DIMENSIONI, MM DIMENSIONS, MM	
	LARGHEZZA (mm) WIDTH (mm)	E
R5CPMIE6600	600	600
R5CPMIE8600	800	600

H 800

CODICE CODE	DIMENSIONI, MM DIMENSIONS, MM	
	LARGHEZZA (mm) WIDTH (mm)	E
R5CPMIE6800	600	800
R5CPMIE8800	800	800

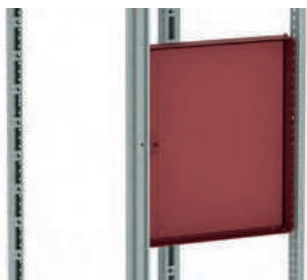

■ Modularità esterna External modularity

Supporto orizzontale parziale e totale Partial and full horizontal support

- Realizzato in lamiera zincata sendzimir 15/10.
- Confezione da 2 pezzi completa di viteria per il fissaggio.

- Made of 15/10 thick Sendzimir galvanized steel.
- Pack of 2 pieces complete with accesories and screws for assembly.



SUPPORTO ORIZZONTALE PARZIALE PARTIAL HORIZONTAL SUPPORT	SUPPORTO ORIZZONTALE TOTALE TOTAL HORIZONTAL SUPPORT	PROFONDITÀ ARMADIO ENCLOSURE DEPTH	C	D	E
-	RZSOE245	300	-	-	-
RZSOE145	RZSOE345	400	125	168	155
RZSOE195	RZSOE345	400	175	118	205
RZSOE145	RZSOE445	500	125	268	155
RZSOE195	RZSOE445	500	175	218	205
RZSOE295	RZSOE445	500	275	118	305
RZSOE145	RZSOE545	600	125	368	155
RZSOE195	RZSOE545	600	175	318	205
RZSOE295	RZSOE545	600	275	218	305
RZSOE145	RZSOE745	800	125	568	155
RZSOE195	RZSOE745	800	175	518	205
RZSOE295	RZSOE745	800 <td 275	418	305	
RZSOE345	RZSOE745	800	325	368	355

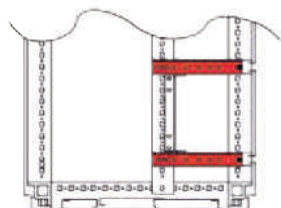
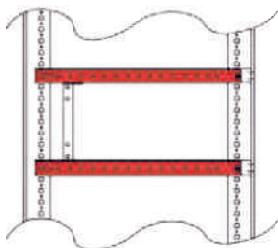
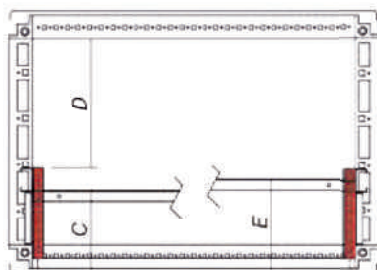
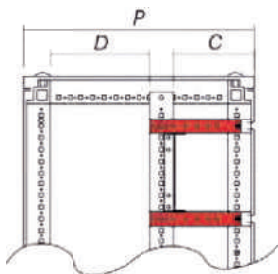

■ Modularità esterna External modularity

Divisorio orizzontale parziale e totale Full and partial horizontal divider

- Realizzato in lamiera zincata Sendzimir 15/10.
- Confezione da 1 pezzo completa di viteria per il fissaggio.

- Made of 15/10 thick Sendzimir galvanized steel.
- Pack of 1 piece complete with accessories and screws for assembly.



Parziale Partial

LARGHEZZA 600 WIDTH 600	LARGHEZZA 800 WIDTH 800	PROFONDITÀ ARMADIO ENCLOSURE DEPTH	C	D	E
-	-	300	-	-	-
RZDOE6145	RZDOE8145	400	125	168	155
RZDOE6195	RZDOE8195	400	175	118	205
RZDOE6145	RZDOE8145	500	125	268	155
RZDOE6195	RZDOE8195	500	175	218	205
RZDOE6295	RZDOE8295	500	275	118	305
RZDOE6145	RZDOE8145	600	125	368	155
RZDOE6195	RZDOE8195	600	175	318	205
RZDOE6295	RZDOE8295	600	275	218	305
RZDOE6145	RZDOE8145	800	125	568	155
RZDOE6195	RZDOE8195	800	175	518	205
RZDOE6295	RZDOE8295	800	275	418	305
RZDOE6345	RZDOE8345	800	325	368	355

Totale Total

LARGHEZZA 600 WIDTH 600	LARGHEZZA 800 WIDTH 800	PROFONDITÀ ARMADIO ENCLOSURE DEPTH	C	D	E
RZDOE6245	RZDOE8245	300	-	-	-
RZDOE6345	RZDOE8345	400	125	168	155
RZDOE6345	RZDOE8345	400	175	118	205
RZDOE6445	RZDOE8445	500	125	268	155
RZDOE6445	RZDOE8445	500	175	218	205
RZDOE6445	RZDOE8445	500	275	118	305
RZDOE6545	RZDOE8545	600	125	368	155
RZDOE6545	RZDOE8545	600	175	318	205
RZDOE6545	RZDOE8545	600	275	218	305
RZDOE6745	RZDOE8745	800	125	568	155
RZDOE6745	RZDOE8745	800	175	518	205
RZDOE6745	RZDOE8745	800	275	418	305
RZDOE6745	RZDOE8745	800	325	368	355

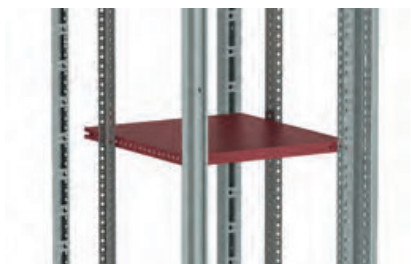
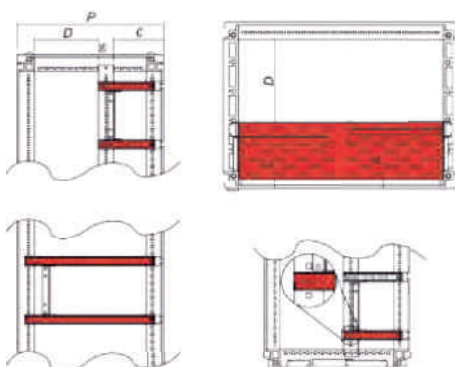

■ Modularità esterna External modularity

Divisorio verticale parziale e totale Full and partial vertical divider

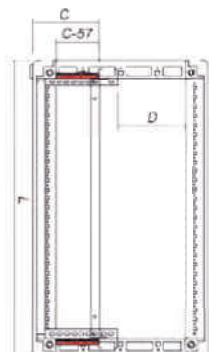
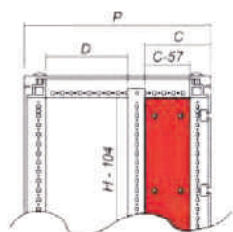

- Realizzato in lamiera zincata sendzimir sp. 15/10.
- Completa di viteria per il fissaggio.
- Confezione 1 pezzo.

- Made of 15/10 thick Sendzimir galvanized steel.
- Complete with fasteners.
- Pack of 1 piece.

Parziale Partial

ALTEZZA ARMADIO H ENCLOSURE HEIGHT H			PROFONDITÀ ARMADIO ENCLOSURE DEPTH P	PROFONDITÀ CELLA CELL DEPTH C
1800	2000	2200		
RZDVP18125	RZDVP20125	-	400	125
RZDVP18175	RZDVP20175	-	400	175
RZDVP18125	RZDVP20125	RZDVP22125	500	125
RZDVP18175	RZDVP20175	RZDVP22175	500	175
RZDVP18275	RZDVP20275	RZDVP22275	500	275
RZDVP18125	RZDVP20125	RZDVP22125	600	125
RZDVP18175	RZDVP20175	RZDVP22175	600	175
RZDVP18275	RZDVP20275	RZDVP22275	600	275
RZDVP18125	RZDVP20125	RZDVP22125	800	125
RZDVP18175	RZDVP20175	RZDVP22175	800	175
RZDVP18275	RZDVP20275	RZDVP22275	800	275
RZDVP18325	RZDVP20325	RZDVP22325	800	325

Totale Total

ALTEZZA ARMADIO H ENCLOSURE HEIGHT H			PROFONDITÀ ARMADIO ENCLOSURE DEPTH P	PROFONDITÀ CELLA CELL DEPTH C
1800	2000	2200		
RZDVE1840	RZDVE2040	-	400	125
RZDVE1840	RZDVE2040	-	400	175
RZDVE1850	RZDVE2050	RZDVE2250	500	125
RZDVE1850	RZDVE2050	RZDVE2250	500	175
RZDVE1850	RZDVE2050	RZDVE2250	500	275
RZDVE1860	RZDVE2060	RZDVE2260	600	125
RZDVE1860	RZDVE2060	RZDVE2260	600	175
RZDVE1860	RZDVE2060	RZDVE2260	600	275
RZDVE1880	RZDVE2080	RZDVE2280	800	125
RZDVE1880	RZDVE2080	RZDVE2280	800	175
RZDVE1880	RZDVE2080	RZDVE2280	800	275
RZDVE1880	RZDVE2080	RZDVE2280	800	325

■ Modularità esterna External modularity

Supporti verticali Vertical support



- Realizzato in lamiera d'acciaio sp. 15/10 zincato sendzimir.
- Confezione da 2 pezzi completa di viteria per il montaggio.
- Obbligatorio nella segregazione parziale.

- Made of 15/10 thick Sendzimir galvanized steel.
- Pack of 2 pieces complete with accessories and screws for assembly.
- Mandatory for partial separation.

H 1800

CODICE
CODE

RZMVE18

H 2000

CODICE
CODE

RZMVE20

H 2200

CODICE
CODE

RZMVE22

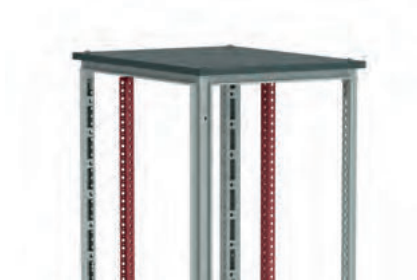
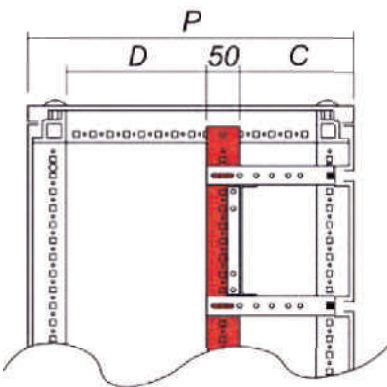

■ Modularità interna per armadi

Internal modularity for enclosures

Configurazione

Configuration



I sistemi modulari per la distribuzione sono stati progettati per un utilizzo sia sulla linea di armadi CQE che sulle linee di armadi CAE. Essi consentono, tramite l'applicazione di componenti particolarmente studiati, l'allestimento di quadri di distribuzione di energia in bassa tensione.

Le strutture degli armadi possono essere configurate in quadri con equipaggiamento modulare, completati da appositi montanti verticali che consentono il fissaggio di pannelli modulari sfinestrati, ciechi o preforati per interruttori scatolati di varie marche con i relativi pannelli di cablaggio regolabili in profondità.

Le strutture degli armadi si possono configurare a celle separate, che unite tra di loro formano scomparti indipendenti. La zona anteriore è riservata agli interruttori, alle misure e ai servizi ausiliari. La zona posteriore, invece, è riservata alle connessioni degli interruttori alle sbarre di derivazione.

È possibile installare il sistema sbarre nella colonna laterale (armadio risalita cavi con accesso frontale) oppure nella zona posteriore dell'armadio, avendo notevoli vantaggi nella realizzazione delle connessioni.

La modularità interna è protetta da porte trasparenti con vetro di sicurezza.

Modular systems for distribution have been designed to be used with both CQE and CAE enclosure series. Using carefully studied components they allow arranging BT distribution boards. Enclosures may be configured of modular equipment panels complete with special vertical uprights, which allow mounting modular cutout panels, blank panels or perforated panels for boxed switches of various brands with relative mounting panels adjustable in depth.

Enclosures may be configured by separated cells, which being coupled together, form independent compartments.

The frontal area is purposed for switches, measurement instruments and auxiliary units. While the rear area is occupied by connections of the switches to branch buses.

It is possible to install a bus system into a side column (cable chamber with front access) or to the rear enclosure area obtaining significant advantages in connection works. Internal modules are protected by glazed doors with safety glass.

Codici lavorazione

Assembling codes

CODICE CODE	DESCRIZIONE DESCRIPTION
RLADE22	Montaggio porte distribuzione Distribution doors mounting
RLACDE22	Montaggio celle di distribuzione Distribution cells mounting

■ **Modularità interna per armadi**
Internal modularity for enclosures

Esempi
Examples



■ Modularità interna per armadi Internal modularity for enclosures

Allestimento armadio Enclosure arrangement

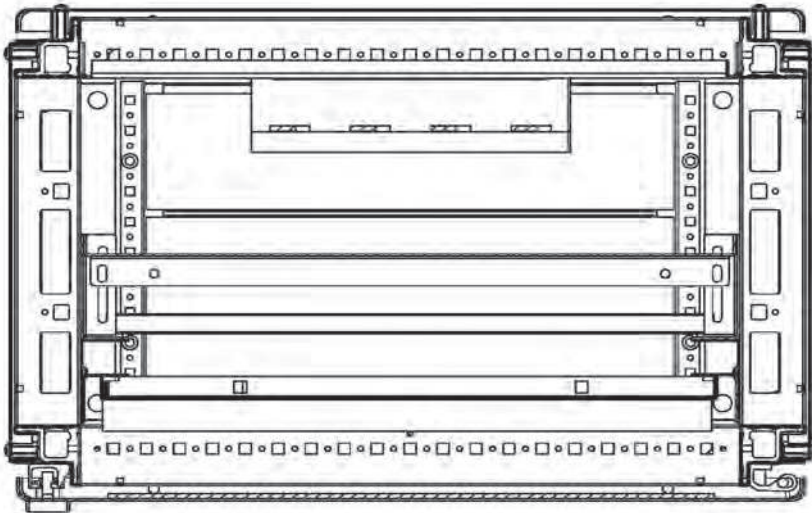

Fissaggio per canalina di cablaggio
anteriore orizzontale
Codice **RZDSF02**
Codice **RZDGR**

Front horizontal fastening bracket
for cable ducts
Code **RZDSF02**
Code **RZDGR**



Guida DIN regolabile completa
di supporti
Codice **RZDGR**

Adjustable DIN guide complete
with supports
Code **RZDGR**

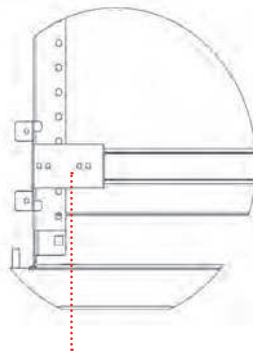
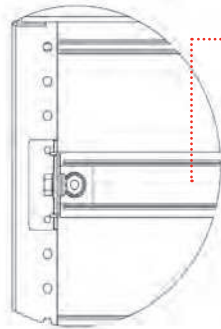

Staffe per fissaggio canalina
cablaggio posteriore
Codice **RZDSF01**

Rear fastening bracket for
cable ducts
Code **RZDSF01**

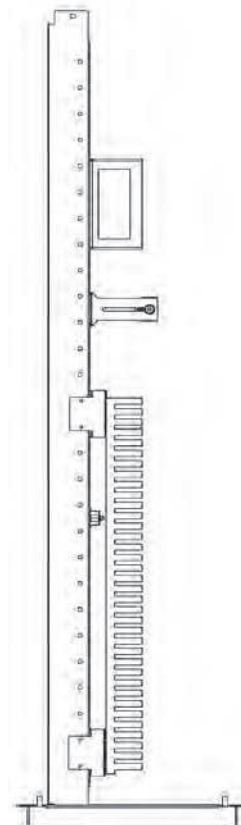
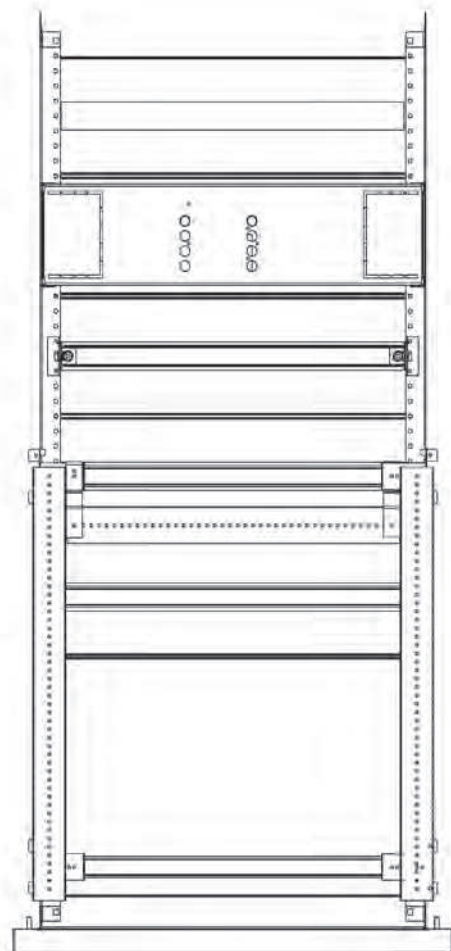

■ Modularità interna per armadi Internal modularity for enclosures

Allestimento armadio Enclosure arrangement

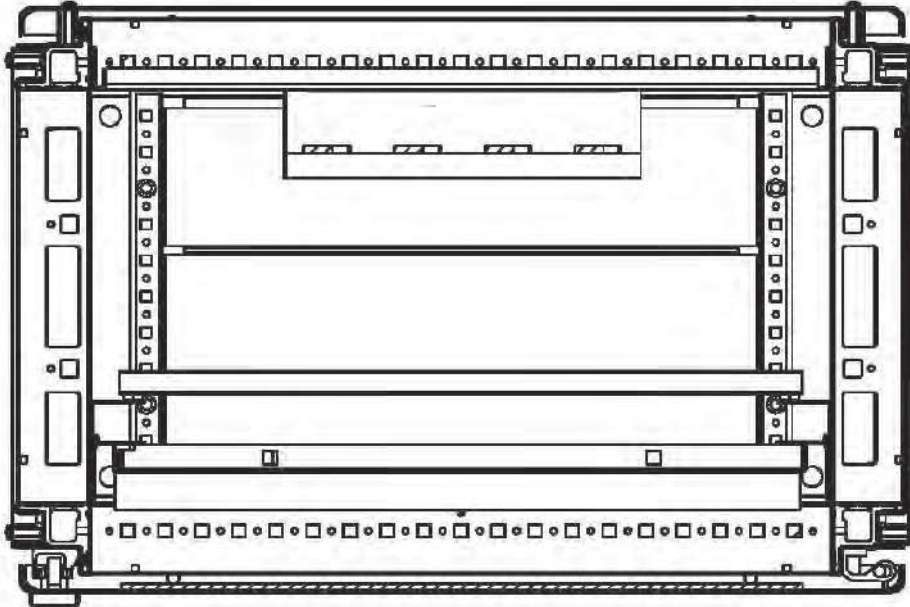

Supporti laterali per pannello
di cablaggio
Codice **DSL**

Side supports for mounting
panel
Code **DSL**

Montante TE
Codice **TE**

TE type upright
Code **TE**

Pannello di cablaggio
Codice **PCE**

Mounting panel
Code **PCE**

Pannello modulare
codice **PI**

Modular panel
Code **PI**

■ Modularità interna per armadi Internal modularity for enclosures

Allestimento armadio Enclosure arrangement

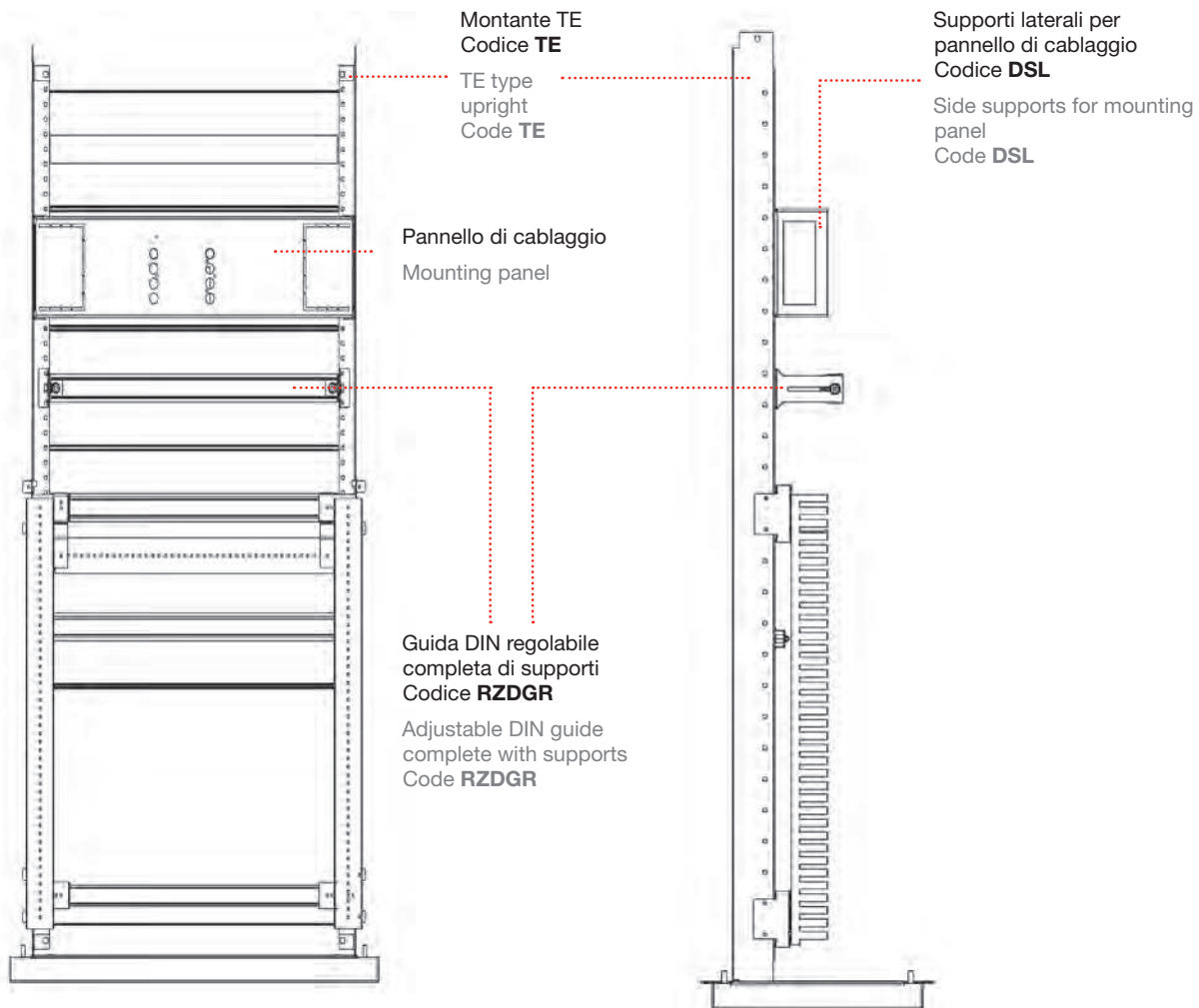

Staffe fissaggio canalina di cablaggio posteriore
Codice **RZDSF01**

Rear fastening bracket for cable ducts
Code **RZDSF01**

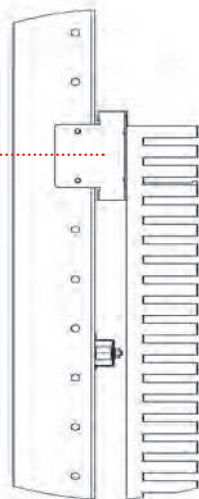

■ Modularità interna Internal modularity

Armadio con retro

CQE enclosure structure and rear panel



Telaio

struttura assemblata con profilo chiuso in acciaio zincato sp. 15/10 verniciato RAL 7035 bucciato.

Tetto e base

lamiera d'acciaio sp. 15/10 verniciati RAL 7011 bucciato, asportabili.

Fondo

lamiera d'acciaio zincato sp. 15/10 con ingresso cavi regolabile.

Retro

lamiera d'acciaio sp. 15/10 verniciato RAL 7035 bucciato e 8 punti di fissaggio alla struttura.

Composizione

telaio, tetto, base, fondo e retro.

Frame

Assembled structure with closed profile in 15/10 thick galvanized steel and painted RAL 7035, textured finish. 25mm vertical chasing on the whole structure allows a quick positioning of the modular doors and for drilling the mounting holes of the hinges and hooks.

Roof and base

Manufactured of 15/10 thick steel, painted textured RAL 7011, removable. Rear panel 15/10 thick steel, painted textured RAL7035 and 8 points of fastening to the structure.

Bottom

15/10 thick galvanized steel, adjustable cable gland.

Composition

Frame, roof, base, rear panel and bottom.

H 1800

CODICE CODE	LARGHEZZA (mm) WIDTH (mm)	DIMENSIONI, MM DIMENSIONS, MM	
		PROFONDITÀ (mm) DEPTH (mm)	
R5CQE1864R	600	400	
R5CQE1865R		500	
R5CQE1866R		600	
R5CQE1868R		800	
R5CQE1884R	800	400	
R5CQE1885R		500	
R5CQE1886R		600	
R5CQE1888R		800	

H 2000

CODICE CODE	LARGHEZZA (mm) WIDTH (mm)	DIMENSIONI, MM DIMENSIONS, MM	
		PROFONDITÀ (mm) DEPTH (mm)	
R5CQE2064R	600	400	
R5CQE2065R		500	
R5CQE2066R		600	
R5CQE2068R		800	
R5CQE2084R	800	400	
R5CQE2085R		500	
R5CQE2086R		600	
R5CQE2088R		800	

■ Modularità interna Internal modularity

Armadio con retro

CQE enclosure structure and rear panel



H 2200

CODICE CODE	DIMENSIONI, MM DIMENSIONS, MM	
	LARGHEZZA (mm) WIDTH (mm)	PROFONDITÀ (mm) DEPTH (mm)
R5CQE2265R		500
R5CQE2266R	600	600
R5CQE2268R		800
R5CQE2285R		500
R5CQE2286R	800	600
R5CQE2288R		800

■ Modularità interna Internal modularity

Armadio con porta trasparente e retro Modular Cabinets with Glass Door and Rear Panel



Telaio

struttura assemblata con profilo chiuso in acciaio zincato sp. 15/10 verniciato RAL 7035 bucciato.

Tetto e base

lamiera d'acciaio sp. 15/10 verniciati RAL 7011 bucciato, asportabili.

Fondo

lamiera d'acciaio zincato sp. 15/10 con ingresso cavi regolabile.

Retro

lamiera d'acciaio sp. 15/10 verniciato RAL 7035 bucciato e 8 punti di fissaggio alla struttura.

Porta

lamiera d'acciaio sp. 20/10 verniciata RAL 7035 bucciato. 4 punti di chiusura, 4 cerniere e mostrina con inserto di chiusura tipo aletta doppio pettine Ø3 mm. Vetro di sicurezza sp. 40/10.

Grado di resistenza all'urto secondo IEC EN 62208; EN50102: IK09.

Composizione

telaio, tetto, base, fondo, retro e porta trasparente.

Structure

Assembled structure with a closed profile in 15/10 thick galvanized steel painted with RAL 7035, textured finish.

Roof and base

Made of 15/10 thick steel, painted with RAL 7011, textured finish. Removable.

Bottom

15/10 thick galvanized steel, adjustable cable gland.

Rear panel

15/10 thick steel sheet, painted with RAL 7035, textured finish, and 8 mounting points to the structure.

Composition

Structure, roof, base, bottom, rear panel and glass door.

Protection degree

IP55 as per EN60529 with a single front door.

H 1800

CODICE CODE	LARGHEZZA (mm) WIDTH (mm)	DIMENSIONI, MM DIMENSIONS, MM	
		PROFONDITÀ (mm) DEPTH (mm)	
R5CQE1864X	600	400	
R5CQE1865X		500	
R5CQE1866X		600	
R5CQE1868X		800	
R5CQE1884X	800	400	
R5CQE1885X		500	
R5CQE1886X		600	
R5CQE1888X		800	

H 2000

CODICE CODE	LARGHEZZA (mm) WIDTH (mm)	DIMENSIONI, MM DIMENSIONS, MM	
		PROFONDITÀ (mm) DEPTH (mm)	
R5CQE2064X	600	400	
R5CQE2065X		500	
R5CQE2066X		600	
R5CQE2068X		800	
R5CQE2084X	800	400	
R5CQE2085X		500	
R5CQE2086X		600	
R5CQE2088X		800	

■ Modularità interna Internal modularity

Armadio con porta trasparente e retro Modular Cabinets with Glass Door and Rear Panel



H 2200

CODICE CODE	DIMENSIONI, MM DIMENSIONS, MM	
	LARGHEZZA (mm) WIDTH (mm)	PROFONDITÀ (mm) DEPTH (mm)
R5CQE2265X		500
R5CQE2266X	600	600
R5CQE2268X		800
R5CQE2285X		500
R5CQE2286X	800	600
R5CQE2288X		800

■ Modularità interna Internal modularity

Pannello di cablaggio modulare Modular mounting plate



- Realizzato in lamiera zincata sendzimir 20/10.
- Regolabile in profondità.
- Completa di viteria per il fissaggio.
- Confezione 1 pezzo.

- Made of 20/10 thick Sendzimir galvanized steel.
- Adjustable in depth.
- Complete with fasteners.
- Pack of 1 piece.

H 200

CODICE CODE	DIMENSIONI, MM DIMENSIONS, MM	
	LARGHEZZA (mm) WIDTH (mm)	E
RZPCE6200	600	200
RZPCE8200	800	

H 300

CODICE CODE	DIMENSIONI, MM DIMENSIONS, MM	
	LARGHEZZA (mm) WIDTH (mm)	E
RZPCE6300	600	300
RZPCE8300	800	

H 400

CODICE CODE	DIMENSIONI, MM DIMENSIONS, MM	
	LARGHEZZA (mm) WIDTH (mm)	E
RZPCE6400	600	400
RZPCE8400	800	

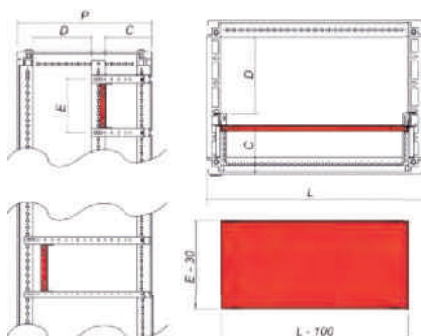

H 500

CODICE CODE	DIMENSIONI, MM DIMENSIONS, MM	
	LARGHEZZA (mm) WIDTH (mm)	E
RZPCE6500	600	500
RZPCE8500	800	

H 600

CODICE CODE	DIMENSIONI, MM DIMENSIONS, MM	
	LARGHEZZA (mm) WIDTH (mm)	E
RZPCE6600	600	600
RZPCE8600	800	

H 800

CODICE CODE	DIMENSIONI, MM DIMENSIONS, MM	
	LARGHEZZA (mm) WIDTH (mm)	E
RZPCE6800	600	800
RZPCE8800	800	

H 900

CODICE CODE	DIMENSIONI, MM DIMENSIONS, MM	
	LARGHEZZA (mm) WIDTH (mm)	E
RZPCE6900	600	900
RZPCE8900	800	

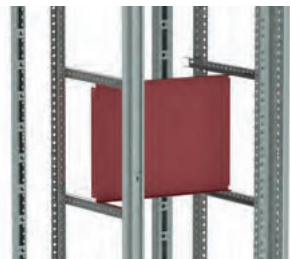

■ Modularità interna Internal modularity

Pannello di cablaggio modulare Modular mounting plate



H 1000

CODICE CODE	DIMENSIONI, MM DIMENSIONS, MM		E E
	LARGHEZZA (mm) WIDTH (mm)		
RZPCE61000	600		1000
RZPCE81000	800		

■ Modularità interna Internal modularity

Supporto orizzontale parziale e totale Partial and full horizontal support

- Realizzato in lamiera zincata sendzimir 15/10.
- Confezione da 2 pezzi completa di viteria per il fissaggio.

- Made of 15/10 thick Sendzimir galvanized steel.
- Pack of 2 pieces complete with accesories and screws for assembly.



SUPPORTO ORIZZONTALE PARZIALE PARTIAL HORIZONTAL SUPPORT	SUPPORTO ORIZZONTALE TOTALE TOTAL HORIZONTAL SUPPORT	PROFONDITÀ ARMADIO ENCLOSURE DEPTH	C	D	E
-	RZSOE145	300	-	-	-
RZSOE095	RZSOE245	400	97	118	127
RZSOE145	RZSOE245	400	147	68	177
RZSOE095	RZSOE345	500	97	218	127
RZSOE145	RZSOE345	500	147	168	177
RZSOE245	RZSOE345	500	247	68	277
RZSOE095	RZSOE445	600	97	318	127
RZSOE145	RZSOE445	600	147	268	177
RZSOE245	RZSOE445	600	247	168	277
RZSOE095	RZSOE645	800	97	518	127
RZSOE145	RZSOE645	800	147	468	177
RZSOE245	RZSOE645	800	247	368	277
RZSOE345	RZSOE645	800	347	268	377

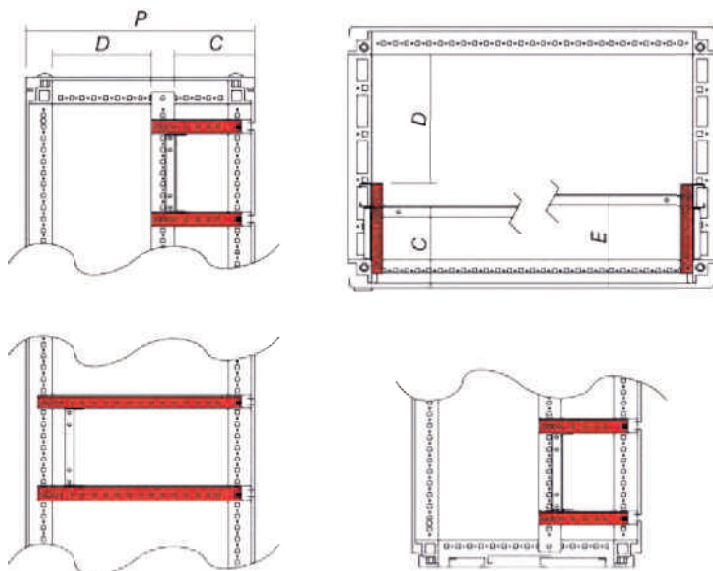

■ Modularità interna Internal modularity

Supporti verticali Vertical support

- Realizzato in lamiera d'acciaio sp. 15/10 zincato sendzimir.
- Confezione da 2 pezzi completa di viteria per il montaggio.
- Obbligatorio nella segregazione parziale.

- Made of 15/10 thick Sendzimir galvanized steel.
- Pack of 2 pieces complete with accesories and screws for assembly.
- Mandatory for partial separation.



H 1800

CODICE
CODE

RZMVE18

H 2000

CODICE
CODE

RZMVE20

H 2200

CODICE
CODE

RZMVE22

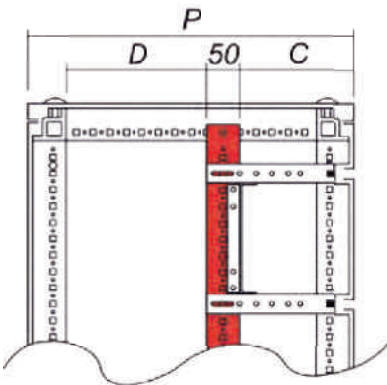

■ Modularità interna Internal modularity

Montanti per pannelli modulari Uprights for modular panels



- Realizzati in lamiera d'acciaio sp. 15/10 verniciati RAL 7035 nella parte esterna e zincati nella parte interna.
- Confezione da 2 pezzi completa di viteria per il montaggio.

- Made of 15/10 thick steel sheet, external side painted RAL 7035 and galvanized internal side.
- Pack of 2 pieces complete with accessories and screws for assembly.

H 1400

CODICE
CODE

R5TE14

H 1600

CODICE
CODE

R5TE16

H 1800

CODICE
CODE

R5TE18

H 2000

CODICE
CODE

R5TE20

H 2200

CODICE
CODE

R5TE22

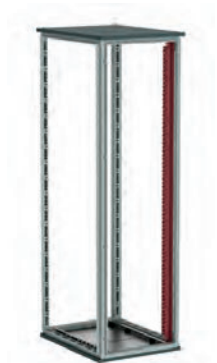
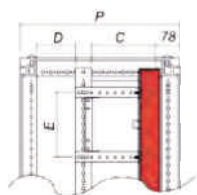

■ Modularità interna Internal modularity

Pannelli di compensazione Blanking panel

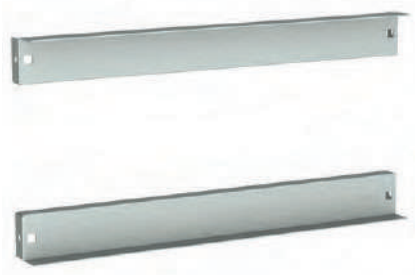

Pannelli di compensazione obbligatori per allestimento fronte quadro. Altezza utile per allestimento = H armadio - 200 mm.

- Realizzati in lamiera d'acciaio sp. 15/10 verniciati RAL 7035 bucciato.
- Confezione da 2 pezzi completa di accessori per il montaggio.

Blanking panels are mandatory for front enclosure arrangement. Width usable for arrangement = H enclosure - 200 mm.

- Made of 15/10 thick steel sheet painted textured RAL 7035.
- Pack of 2 pieces complete with mounting accessories.

H 50

CODICE CODE	DIMENSIONI, MM DIMENSIONS, MM
	LARGHEZZA (mm) WIDTH (mm)
R5PCD60	600
R5PCD80	800



■ Modularità interna Internal modularity

Pannello modulare con cava DIN Modular Panel for DIN modules



- Realizzati in lamiera d'acciaio sp. 15/10 verniciati RAL 7035 bucciato.
- I pannelli con cava per moduli DIN sono comprensivi di relativa guida DIN.
- Confezione da 1 pezzo completa di accessori per il montaggio.

- Made of 15/10 thick steel sheet painted textured RAL 7035.
- Panels with DIN cut-out are provided with the relative DIN guide.
- Pack of 1 piece complete with mounting accessories.

H 150

CODICE CODE	LARGHEZZA (mm) WIDTH (mm)	DIMENSIONI, MM DIMENSIONS, MM	
		APERTURE OPENINGS	NUMERO MODULI MODULES NUMBER
R5PI5151	600	1	23
R5PI7151	800		34

H 200

CODICE CODE	LARGHEZZA (mm) WIDTH (mm)	DIMENSIONI, MM DIMENSIONS, MM	
		APERTURE OPENINGS	NUMERO MODULI MODULES NUMBER
R5PI521	600	1	23
R5PI721	800		34

H 300

CODICE CODE	LARGHEZZA (mm) WIDTH (mm)	DIMENSIONI, MM DIMENSIONS, MM	
		APERTURE OPENINGS	NUMERO MODULI MODULES NUMBER
R5PI531	600	1	23
R5PI731	800		34

H 400

CODICE CODE	LARGHEZZA (mm) WIDTH (mm)	DIMENSIONI, MM DIMENSIONS, MM	
		APERTURE OPENINGS	NUMERO MODULI MODULES NUMBER
R5PI541	600	2	23
R5PI741	800		34

H 600

CODICE CODE	LARGHEZZA (mm) WIDTH (mm)	DIMENSIONI, MM DIMENSIONS, MM	
		APERTURE OPENINGS	NUMERO MODULI MODULES NUMBER
R5PI561	600	3	23
R5PI761	800	2	34



R5PI520A
R5PI720A

R5PI522
R5PI722

R5PI524
R5PI724

R5PI521
R5PI541
R5PI561
R5PI721
R5PI741
R5PI761

R5PI520
R5PI530
R5PI540
R5PI560
R5PI580
R5PI5100
R5PI720
R5PI730
R5PI740
R5PI760

■ Modularità interna Internal modularity

Pannello modulare con fori quadri Modular Panel + holes

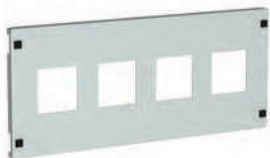

- Realizzati in lamiera d'acciaio sp. 15/10 verniciati RAL 7035 bucciato.
- I pannelli con cava per moduli DIN sono comprensivi di relativa guida DIN.
- Confezione da 1 pezzo completa di accessori per il montaggio.

- Made of 15/10 thick steel sheet painted textured RAL 7035.
- Panels with DIN cut-out are provided with the relative DIN guide.
- Pack of 1 piece complete with mounting accessories.

H 200

CODICE CODE	LARGHEZZA (mm) WIDTH (mm)	DIMENSIONI, MM DIMENSIONS, MM	APERTURE OPENINGS
R5PI522	600		2 fori 68x68
R5PI524			4 fori 68x68 + 1 for diam.10
R5PI724	800		4 68x68 + 1 diam.10
R5PI722			2 68x68

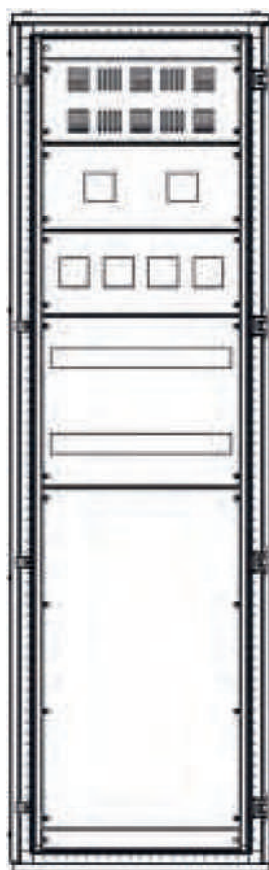

R5PI520A
R5PI720A

R5PI522
R5PI722

R5PI524
R5PI724

R5PI521
R5PI541
R5PI561
R5PI721
R5PI741
R5PI761

R5PI520
R5PI530
R5PI540
R5PI560
R5PI580
R5PI5100
R5PI720
R5PI730
R5PI740
R5PI760

■ Modularità interna Internal modularity

Pannello modulare cieco Blank modular panel



H 800

CODICE CODE	DIMENSIONI, MM DIMENSIONS, MM LARGHEZZA (mm) WIDTH (mm)
R5PI580	600
R5PI780	800

H 1000

CODICE CODE	DIMENSIONI, MM DIMENSIONS, MM LARGHEZZA (mm) WIDTH (mm)
R5PI5100	600
R5PI7100	800

Pannello modulare alettato Finned Modular Panel

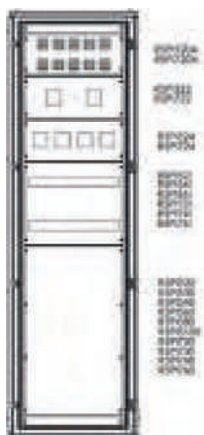

- Realizzati in lamiera d'acciaio sp. 15/10 verniciati RAL 7035 bucciato.
- I pannelli con cava per moduli DIN sono comprensivi di relativa guida DIN.
- Confezione da 1 pezzo completa di accessori per il montaggio.

- Made of 15/10 thick steel sheet painted textured RAL 7035.
- Panels with DIN cut-out are provided with the relative DIN guide.
- Pack of 1 piece complete with mounting accessories.

H 200

CODICE CODE	DIMENSIONI, MM DIMENSIONS, MM LARGHEZZA (mm) WIDTH (mm)
R5PI520A	600
R5PI720A	800

■ Modularità interna Internal modularity

Pannello modulare cieco Blank modular panel



H 800

CODICE CODE	DIMENSIONI, MM DIMENSIONS, MM LARGHEZZA (mm) WIDTH (mm)
R5PI580	600
R5PI780	800

H 1000

CODICE CODE	DIMENSIONI, MM DIMENSIONS, MM LARGHEZZA (mm) WIDTH (mm)
R5PI5100	600
R5PI7100	800

Pannello modulare alettato Finned Modular Panel

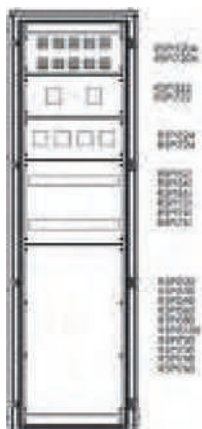

- Realizzati in lamiera d'acciaio sp. 15/10 verniciati RAL 7035 bucciato.
- I pannelli con cava per moduli DIN sono comprensivi di relativa guida DIN.
- Confezione da 1 pezzo completa di accessori per il montaggio.
- Made of 15/10 thick steel sheet painted textured RAL 7035.
- Panels with DIN cut-out are provided with the relative DIN guide.
- Pack of 1 piece complete with mounting accessories.

H 200

CODICE CODE	DIMENSIONI, MM DIMENSIONS, MM LARGHEZZA (mm) WIDTH (mm)
R5PI520A	600
R5PI720A	800

■ Modularità interna Internal modularity

Pannello modulare di arretramento Inward modular panel



- Realizzato in lamiera d'acciaio sp. 15/10 verniciato RAL 7035 bucciato.
- Consente l'utilizzo di interruttori con leva di comando alta fino a 100 mm.
- Confezione da 1 pezzo completa di accessori per il montaggio.
- Distanza porta - incasso 110mm

- Made of 15/10 steel sheet, painted textured RAL 7035.
- Allows utilizing switches with high control lever up to 100 mm.
- Pack of 1 piece complete with mounting accessories.
- Distance between door and recess 110mm.

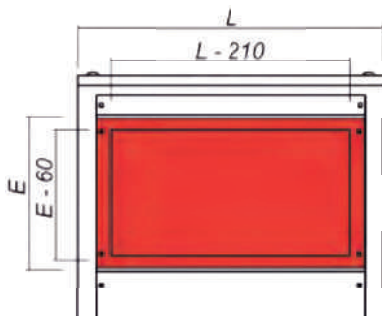

H 400

CODICE CODE	DIMENSIONI, MM DIMENSIONS, MM
	LARGHEZZA (mm) WIDTH (mm)
R5PA6040	600
R5PA8040	800

H 600

CODICE CODE	DIMENSIONI, MM DIMENSIONS, MM
	LARGHEZZA (mm) WIDTH (mm)
R5PA6060	600
R5PA8060	800

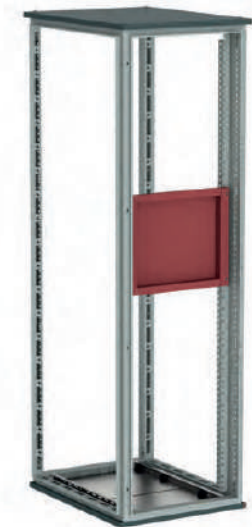

■ Modularità interna Internal modularity

Battuta per pannelli Ledge for panels

- Realizzata in lamiera d'acciaio sp. 15/10 zincata Sendzimir.
- Confezione 1 pezzo completa di accessori per il montaggio.

- Made of 15/10 thick Sendzimir galvanized steel.
- Pack of 1 piece complete with mounting accessories



CODICE CODE	DIMENSIONI, MM DIMENSIONS, MM
	LARGHEZZA (mm) WIDTH (mm)
RZBPE60	600
RZBPE80	800

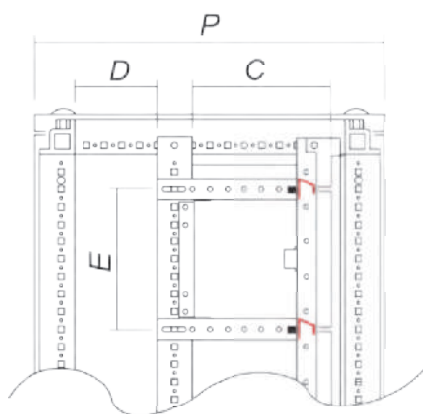

■ Modularità interna Internal modularity

Divisorio verticale parziale e totale Full and partial vertical divider

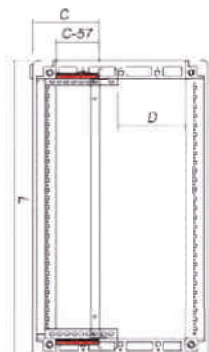
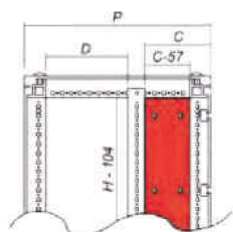

- Realizzato in lamiera zincata sendzimir sp. 15/10.
- Completa di viteria per il fissaggio.
- Confezione 1 pezzo.

- Made of 15/10 thick Sendzimir galvanized steel.
- Complete with fasteners.
- Pack of 1 piece.

Parziale Partial

ALTEZZA ARMADIO H ENCLOSURE HEIGHT H			PROFONDITÀ ARMADIO ENCLOSURE DEPTH	PROFONDITÀ CELLA CELL DEPTH
1800	2000	2200	P	C
RZDVP18100	RZDVP20100		400	97
RZDVP18150	RZDVP20150		400	147
RZDVP18100	RZDVP20100	RZDVP22100	500	97
RZDVP18150	RZDVP20150	RZDVP22150	500	147
RZDVP18250	RZDVP20250	RZDVP22250	500	247
RZDVP18100	RZDVP20100	RZDVP22100	600	97
RZDVP18150	RZDVP20150	RZDVP22150	600	147
RZDVP18250	RZDVP20250	RZDVP22250	600	247
RZDVP18100	RZDVP20100	RZDVP22100	800	97
RZDVP18150	RZDVP20150	RZDVP22150	800	147
RZDVP18250	RZDVP20250	RZDVP22250	800	247
RZDVP18350	RZDVP20350	RZDVP22350	800	347

Totale Total

ALTEZZA ARMADIO H ENCLOSURE HEIGHT H			PROFONDITÀ ARMADIO ENCLOSURE DEPTH	PROFONDITÀ CELLA CELL DEPTH
1800	2000	2200	P	C
RZDVE1840	RZDVE2040		400	97
RZDVE1840	RZDVE2040		400	147
RZDVE1850	RZDVE2050	RZDVE2250	500	97
RZDVE1850	RZDVE2050	RZDVE2250	500	147
RZDVE1850	RZDVE2050	RZDVE2250	500	247
RZDVE1860	RZDVE2060	RZDVE2260	600	97
RZDVE1860	RZDVE2060	RZDVE2260	600	147
RZDVE1860	RZDVE2060	RZDVE2260	600	247
RZDVE1880	RZDVE2080	RZDVE2280	800	97
RZDVE1880	RZDVE2080	RZDVE2280	800	147
RZDVE1880	RZDVE2080	RZDVE2280	800	247
RZDVE1880	RZDVE2080	RZDVE2280	800	347

■ Modularità interna Internal modularity

Pannello di tamponamento Buffer panel

- Realizzato in lamiera d'acciaio sp. 15/10 zincata sendzimir.
- Interposto tra due pannelli di cablaggio serve a garantire un grado di protezione IP 20.
- Confezione da 5 pezzi completa di viteria per il fissaggio.

- Made of 15/10 thick Sendzimir galvanized steel.
- Being interposed between mounting panels it is purposed to provide IP20 protection degree.
- Pack of 5 pieces complete with accessories and screws for assembly.

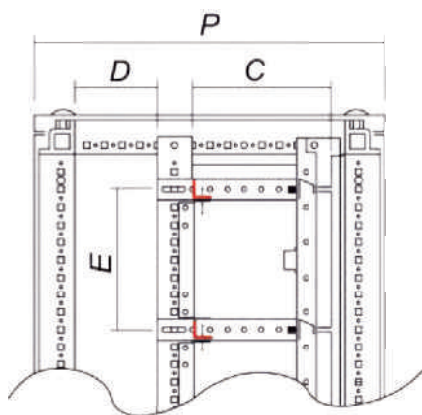

CODICE CODE	DIMENSIONI, MM DIMENSIONS, MM LARGHEZZA (mm) WIDTH (mm)
RZFCP60	600
RZFCP80	800



■ Modularità interna Internal modularity

Modularità interna con fascia laterale Internal module with side compartment

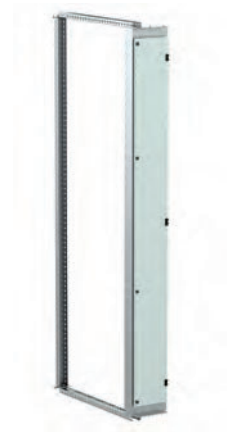

- 1 Fascia laterale con porta.
 - 2 Coppia di traverse intermedie (montate in profondità).
 - 3 Montante posteriore.
- Completa di viteria per il montaggio.

- 1 Side compartment with door.
 - 2 Pair of intermediate rails (mounted inwards).
 - 3 Rear upright.
- Complete with accessories and screws for assembly.

H 1800

CODICE CODE	DIMENSIONI, MM DIMENSIONS, MM
	LARGHEZZA (mm) WIDTH (mm)
R5PF1840	400
R5PF1850	500
R5PF1860	600
R5PF1880	800

H 2000

CODICE CODE	DIMENSIONI, MM DIMENSIONS, MM
	LARGHEZZA (mm) WIDTH (mm)
R5PF2040	400
R5PF2050	500
R5PF2060	600
R5PF2080	800

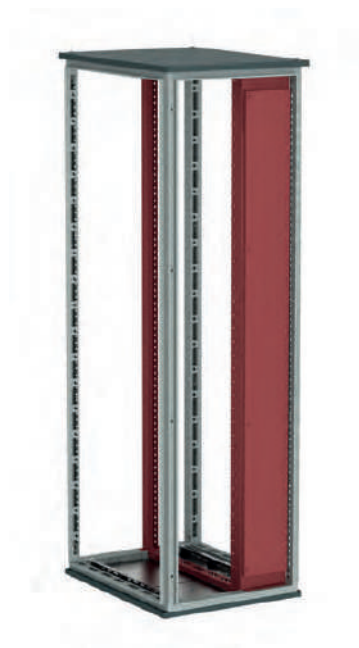
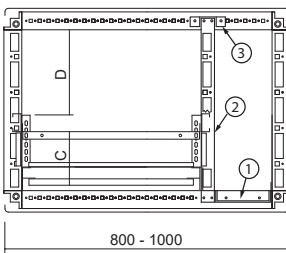

■ Modularità interna Internal modularity

Supporti laterali per pannello di cablaggio Side supports for mounting plate



- Realizzati in lamiera d'acciaio zincata sp.20/10 completi di viteria per il montaggio.
- Supporti asolati per il fissaggio dei pannelli di cablaggio preforati per interruttori scatolati e ciechi (vedi ART. PCE 6200-8200-8400).
- Regolabili in profondità.
- Massima distanza pannello frontale e pannello di cablaggio 118mm.
- Confezione N°1 coppia.

- Made of 20/10 thick galvanized steel, complete with accessories and screws for assembly.
- Slotted supports purposed for fixing pre-drilled wiring panels for boxed and blank switches (please, refer to codes PCE 6200-8200-8400).
- Adjustable in depth.
- Front panel to mounting panel max. distance is equal to 118 mm.
- Pack of 1 pair.

H 200

CODICE CODE	DIMENSIONI, MM DIMENSIONS, MM
	ALTEZZA ELEMENTO (mm) ELEMENT HEIGHT (mm)
RZDSL20	200

H 300

CODICE CODE	DIMENSIONI, MM DIMENSIONS, MM
	ALTEZZA ELEMENTO (mm) ELEMENT HEIGHT (mm)
RZDSL30	300

H 400

CODICE CODE	DIMENSIONI, MM DIMENSIONS, MM
	ALTEZZA ELEMENTO (mm) ELEMENT HEIGHT (mm)
RZDSL40	400

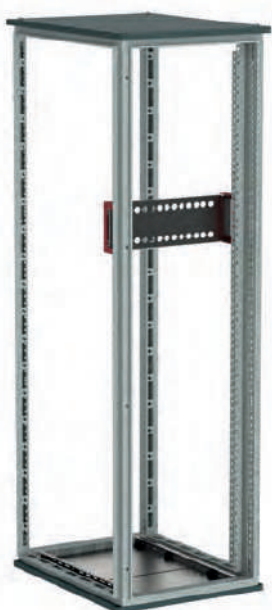

■ Modularità interna Internal modularity

Supporto orizzontale parziale e totale Partial and full horizontal support

- Realizzato in lamiera zincata sendzimir 15/10.
- Confezione da 2 pezzi completa di viteria per il fissaggio.

- Made of 15/10 thick Sendzimir galvanized steel.
- Pack of 2 pieces complete with accesories and screws for assembly.



SUPPORTO ORIZZONTALE PARZIALE PARTIAL HORIZONTAL SUPPORT	SUPPORTO ORIZZONTALE TOTALE TOTAL HORIZONTAL SUPPORT	PROFONDITÀ ARMADIO ENCLOSURE DEPTH	C	D	E
-	RZSOE145	300	-	-	-
RZSOE095	RZSOE245	400	97	118	127
RZSOE145	RZSOE245	400	147	68	177
RZSOE095	RZSOE345	500	97	218	127
RZSOE145	RZSOE345	500	147	168	177
RZSOE245	RZSOE345	500	247	68	277
RZSOE095	RZSOE445	600	97	318	127
RZSOE145	RZSOE445	600	147	268	177
RZSOE245	RZSOE445	600	247	168	277
RZSOE095	RZSOE645	800	97	518	127
RZSOE145	RZSOE645	800	147	468	177
RZSOE245	RZSOE645	800	247	368	277
RZSOE345	RZSOE645	800	347	268	377

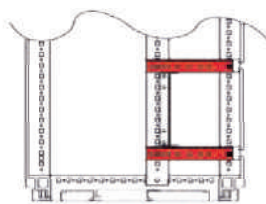
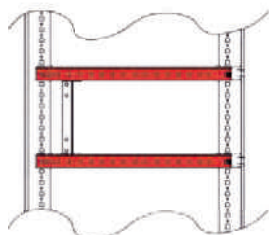
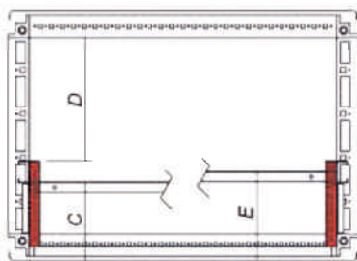
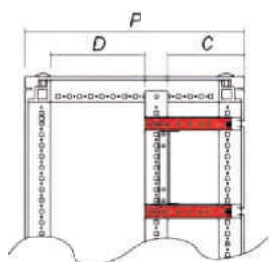

■ Modularità interna Internal modularity

Divisorio orizzontale parziale e totale Full and partial horizontal divider

- Realizzato in lamiera zincata Sendzimir 15/10.
- Confezione da 1 pezzo completa di viteria per il fissaggio.

- Made of 15/10 thick Sendzimir galvanized steel.
- Pack of 1 piece complete with accessories and screws for assembly.

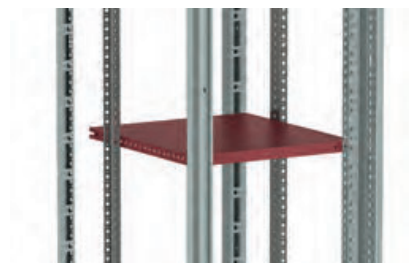

DIVISORIO ORIZZONTALE PARZIALE PARTIAL HORIZONTAL DIVIDER		DIVISORIO ORIZZONTALE TOTALE TOTAL HORIZONTAL DIVIDER		PROFONDITÀ ARMADIO ENCLOSURE DEPTH	C	D	E
LARGHEZZA 600 WIDTH 600	LARGHEZZA 800 WIDTH 800	LARGHEZZA 600 WIDTH 600	LARGHEZZA 800 WIDTH 800				
-	-	RZDOE6145	RZDOE8145	300	-	-	-
RZDOE6095	RZDOE8095	RZDOE6245	RZDOE8245	400	97	118	127
RZDOE6145	RZDOE8145	RZDOE6245	RZDOE8245	400	147	68	177
RZDOE6095	RZDOE8095	RZDOE6345	RZDOE8345	500	97	218	127
RZDOE6145	RZDOE8145	RZDOE6345	RZDOE8345	500	147	168	177
RZDOE6245	RZDOE8245	RZDOE6345	RZDOE8345	500	247	68	277
RZDOE6095	RZDOE8095	RZDOE6445	RZDOE8445	600	97	318	127
RZDOE6145	RZDOE8145	RZDOE6445	RZDOE8445	600	147	268	177
RZDOE6245	RZDOE8245	RZDOE6445	RZDOE8445	600	247	168	277
RZDOE6095	RZDOE8095	RZDOE6645	RZDOE8645	800	97	518	127
RZDOE6145	RZDOE8145	RZDOE6645	RZDOE8645	800	147	468	177
RZDOE6245	RZDOE8245	RZDOE6645	RZDOE8645	800	247	368	277
RZDOE6345	RZDOE8345	RZDOE6645	RZDOE8645	800	347	268	377

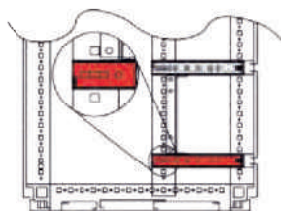
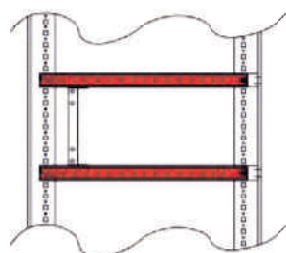
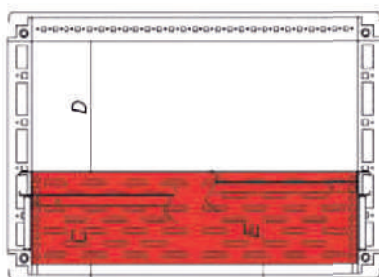
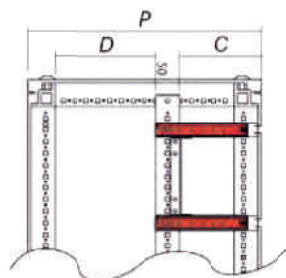

■ Modularità interna

Internal modularity

Guida DIN per morsettiere orizzontale

Horizontal DIN guide for terminal boards



- Guida DIN 35x15 con supporti per il montaggio
- E' fissata direttamente al montante ART. TE
- Confezione da 1 pezzo completa di accessori per il montaggio

- 35x15 DIN guide with mounting supports
- To be fixed directly to upright ART. TE
- Pack of 1 piece complete with mounting accessories

CODICE CODE	DIMENSIONI, MM DIMENSIONS, MM LARGHEZZA (mm) WIDTH (mm)
RZDGD60	600
RZDGD80	800

Traversa di fissaggio supporti per barre - cavi laterale

Side rail for bus supports and cables fixing



- Realizzata in lamiera d'acciaio zincata Sendzimir sp.20/10. Il profilo è dotato di una fila di fori diametro 6 e di fori diametro 9 con passo 25mm.
- Confezione da 4 pezzi completa di viteria per il montaggio.

Utilizzata:

1. sulla profondità dell'armadio.
2. sotto il tetto dell'armadio sulla profondità.

- Made of 20/10 thick Sendzimir galvanized steel. The profile is provided with a row of holes with Ø6 and Ø9 with 25 mm pitch.
- Pack of 4 pieces complete with accessories and screws for assembly.

To be applied:

1. along the enclosure width.
2. under the roof along the enclosure width.

CODICE CODE	DIMENSIONI, MM DIMENSIONS, MM PROFONDITÀ (mm) DEPTH (mm)
RZDL40	400
RZDL50	500
RZDL60	600
RZDL80	800

■ Modularità interna Internal modularity

Traversa di fissaggio supporti per barre - cavi sul fondo dell'armadio Cross rail bar supports - cables on the bottom of the cabinet



- Realizzate in lamiera d'acciaio zincata sendzimir sp.20/10 il profilo è dotato di una fila di fori diametro 6 e diametro 9 a passo 25mm.
- Confezione da 4 pezzi completa di viteria per il montaggio.

- Made of 20/10 thick Sendzimir galvanized steel, provided with a row of holes Ø 6 and Ø 9 with a 25 mm pitch.
- Pack of 4 pieces complete with accessories and screws for assembly.

CODICE CODE	LARGHEZZA (mm) WIDTH (mm)	DIMENSIONI, MM DIMENSIONS, MM	CARICO MAX MAX LOAD
RZDTF30	300		105
RZDTF40	400		100
RZDTF60	600		90
RZDTF80	800		80
RZDTF100	1000		60
RZDTF120	1200		45



■ Modularità interna Internal modularity

Guida DIN regolabile completa di supporti Adjustable DIN rail with support



- N°1 guida DIN 35x15 mm
- N°2 supporti realizzati in lamiera d'acciaio zincata sp. 20/10 regolabili in profondità.
- Montata direttamente al montante (ART.TE) permette il fissaggio delle apparecchiature modulari o non modulari in profondità. Può essere regolata da una quota minima pari a 46mm a una massima di 118mm.
- Confezione da 1 pezzo completa di viteria per il montaggio.

- N° 1 35x15 mm DIN guide.
- N° 2 supports of 20/10 thick galvanized steel, adjustable in depth.
- Being mounted directly to an (ART. TE) upright allows fixing modular and non-modular equipment in depth. The adjustment range starts at a min. depth of 46 mm up to a 118 mm max.
- Pack of 1 piece complete with accessories and screws for assembly.

CODICE CODE	DIMENSIONI, MM DIMENSIONS, MM
	LARGHEZZA (mm) WIDTH (mm)
RZDGR60	600
RZDGR80	800

■ Modularità interna

Internal modularity

Staffe per fissaggio canalina cablaggio posteriore

Rear fastening bracket for cable ducts



- Realizzate in lamiera d'acciaio p.20/10 zincata fissate direttamente sui montanti (ART. TE)
- Permettono il fissaggio della canalina posteriore sia in verticale che in orizzontale (L.60mm MAX) e lo sfruttamento totale dello spazio per le apparecchiature.
- Completa di viteria per il montaggio.

- Made of 20/10 thick galvanized steel, to be fixed directly to ART. TE uprights.
- Allows cable duct rear mounting both vertically and horizontally (L.60mm MAX) and complete utilization of the space for equipment.
- Complete with accessories and screws for assembly.

CODICE CODE	DIMENSIONI, MM DIMENSIONS, MM CONFEZIONI/PZ PACK/PCS
RZDSF01	4

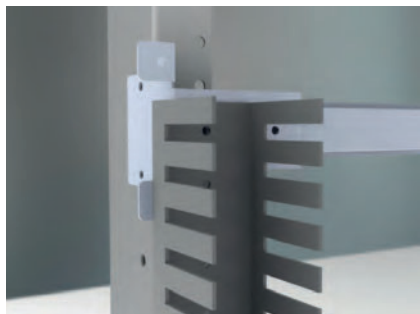

■ Modularità interna

Internal modularity

Fissaggio per canalina di cablaggio anteriore orizzontale

Front horizontal fastening bracket for cable ducts



- Realizzato in lamiera d'acciaio sp.20/10 zincata pu. essere fissato direttamente alla staffa ART. RZDSF01 oppure direttamente alla guida DIN.
- Completa di viteria per il montaggio.

- Made of 20/10 thick galvanized steel, may be mounted directly to RZDSF01 bracket or directly to a DIN guide.
- Complete with accessories and screws for assembly.

CODICE CODE	DIMENSIONI, MM DIMENSIONS, MM CONFEZIONI/PZ PACK/PCS
RZDSF02	10



■ Modularità interna

Internal modularity

Staffe porta canalina per strumenti di misura quadrati

Cable duct bracket for square measurement instruments



- Realizzata in lamiera d'acciaio zincato sp.10/10.
- Confezioni da 10 pezzi.
- Completa di accessori per il montaggio.

- Made of 10/10 thick galvanized steel.
- Pack of 10 pieces.
- Complete with mounting accessories.

CODICE CODE	DIMENSIONI, MM DIMENSIONS, MM
	FORO HOLE
RZDPC72	72x72
RZDPC96	96x96



■ Modularità interna

Internal modularity

Staffe porta canalina per pulsanti

Cable duct bracket for pushbuttons



- Realizzata in lamiera d'acciaio zincato sp.10/10.
- Completa di accessori per il montaggio.

- Made of 10/10 thick galvanized steel.
- Complete with mounting accessories.

CODICE CODE	CONFEZIONI/PZ PACK/PCS	DIMENSIONI, MM DIMENSIONS, MM	FORO HOLE
RZDPC30	30		30
RZDPC22	50		22





Casse CE
CE boxes

■ Casse CE CE boxes

Per installazione INDOOR For INDOOR installation



Struttura

Struttura in lamiera d'acciaio spessore 15/10 con saldatura continua sulle giunzioni.

Fondo cassa dotato di serie di flangia ingresso cavi installata a filo struttura, provvista di guarnizione e fissata con viti autofilettanti.

Quattro fori sulla parte posteriore permettono il fissaggio a parete, diretto oppure tramite apposite staffe (codice RZA62).

Quattro prigionieri M6 consentono il fissaggio degli accessori: porte interne, telai modulari o telai rack girevoli.

Porte

Realizzate in lamiera d'acciaio spessore 15/10 (per altezze fino a 800 mm) oppure 20/10 (per tutte le altezze maggiori di 800 mm).

Nella parte interna è possibile fissare due profili forati a passo 25 mm. Utili per irrobustire la porta o per l'ancoraggio di tutti i tipi di applicazione.

Porta reversibile

Disponibili le versioni trasparenti con vetro di sicurezza di spessore 4 mm.

Previste cerniere con angolo di apertura di 130°.

Dotate di guarnizione poliuretanicata posata in colata continua.

Aggiungere porta a vetro.

Pannello di cablaggio

Previsto di serie su tutte le casse.

Lamiera d'acciaio zincato SENDZIMIR® spessore 20/10.

Dettagliare quali pannelli sono ribordati.

La linea di casse CE è costituita da diverse altezze standard, da 300mm fino a 1400mm.

La verniciatura viene eseguita di serie con polveri epossipoliesteri, colore standard RAL 7035.

Il ciclo di verniciatura standard applicato è classificabile, secondo la norma UNI ISO 12944-2018, come C3 con durabilità M.

Il grado di protezione delle casse CE in esecuzione a singola anta è IP66. In esecuzione a doppia anta è IP55.

Structure

15/10 thick sheet steel structure with continuous welding on the joints.

Case back equipped as standard with cable entry flange installed flush with the structure, equipped with gasket and fixed with self-tapping screws.

Four holes on the rear allow for wall mounting, either directly or through special brackets (code RZA62).

Four M6 studs allow accessories to be fixed: internal doors, modular frames or revolving rack frames.

Doors

Made of sheet steel 15/10 thick (for heights up to 800 mm) or 20/10 (for all heights greater than 800 mm).

On the inside it is possible to fix two perforated profiles with 25 mm pitch. Useful for strengthening the door or for anchoring all types of applications.

Reversible door

Transparent versions with 4 mm thick safety glass available.

Hinges with 130° opening angle are provided.

Equipped with polyurethane gasket laid in continuous casting.

Add glass door.

Wiring panel

Provided as standard on all speakers.

SENDZIMIR® galvanized steel sheet thickness 20/10.

Detail which panels are rimmed.

The CE speaker line consists of different standard heights, from 300mm up to 1400mm.

The painting is carried out as standard with epoxy-polyester powders, standard color RAL 7035.

The applied standard painting cycle can be classified, according to UNI ISO 12944-2018, as C3 with durability M.

The degree of protection of the CE enclosures in single leaf execution is IP66. Double leaf execution is IP55.

■ Casse CE

CE boxes

Caratteristiche tecniche

Technical characteristics

Conformità e omologazioni

Conformity and approvals



Grado di protezione

- Casse con anta doppia **IP 55** in accordo con IEC EN 62208; EN 60529
- Casse con anta singola **IP 66** in accordo con IEC EN 62208; EN 60529
- **TYPE 4** in accordo con UL508A; UL50 (singola anta cieca)
- **TYPE 12** in accordo con UL508A; UL50 (doppia anta cieca)
- Grado di protezione garantito dalla guarnizione in schiuma poliuretana bi-componente
- Grado di resistenza all'urto **IK10** in accordo con IEC EN 62208; EN 50102

Protection degree

- Double door boxes **IP 55** in accordance with IEC EN 62208; EN 60529
- Single door boxes **IP 66** in accordance with IEC EN 62208; EN 60529
- **TYPE 4** in accordance with UL508A; UL50 (single blind door)
- **TYPE 12** in accordance with UL508A; UL50 (double blind door)
- The protection degree is guaranteed by a two-component polyurethane foam seal
- Impact resistance degree **IK10** according to IEC EN 62208; EN 50102

Struttura in lamiera d'acciaio 15/10.
15/10 steel sheet structure

Fissaggio diretto a parete
oppure mediante staffe
(opzionali).
Direct mounting to a wall or
using brackets (optional)

Porta anteriore reversibile.
Predisposta per il montaggio
delle guide di rinforzo.
Reversible front door.
Prepared for reinforcement
guides mounting

Pannello di cablaggio incluso
nella fornitura. Sp. 20/10.
20/10 thick mounting plate
included in the delivery set

Chiusura standard a box
o a cariglione in base al
modello.
Standard box or ratchet
lock depending on the
model

Foratura sul fondo con flangia
asportabile per passaggio cavi.
Bottom opening with removable
cover plate for cable passage

Cerniere con apertura 130° std.
Standard hinges with 130°
opening

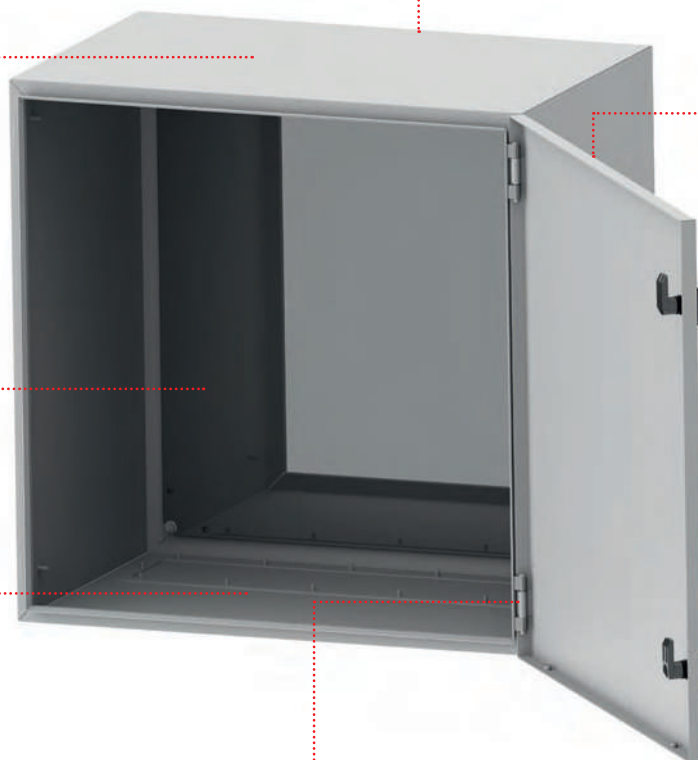

■ **Casse CE**
CE boxes

Anta singola
Single door

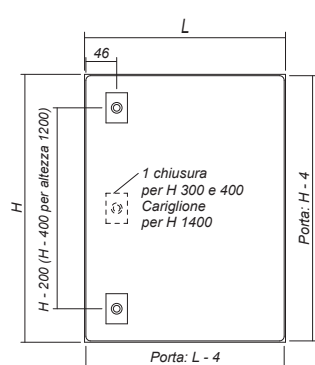

Vista fronte cassa con porta

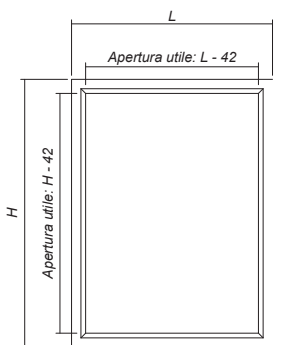

Vista fronte cassa senza porta



Vista retro cassa

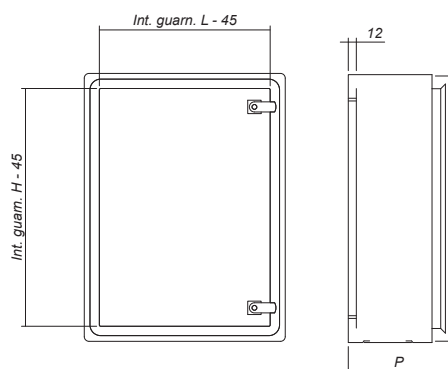

Vista interno porta

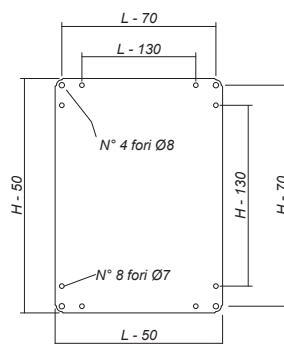

Vista pannello di cablaggio

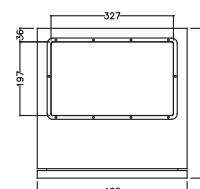
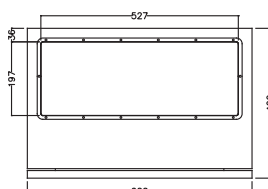
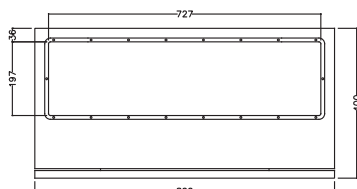
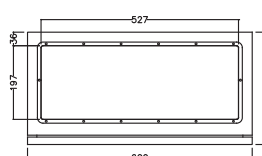
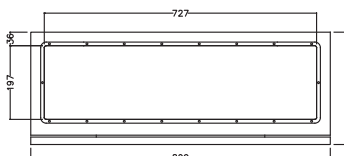
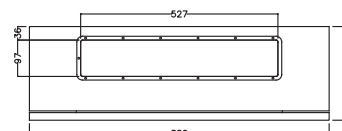
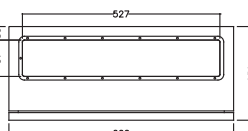
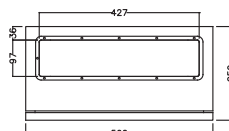
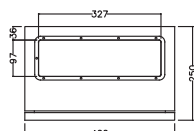
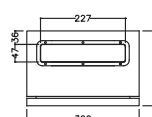
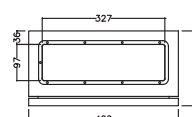
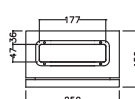
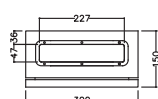
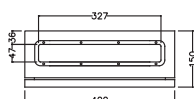

■ Casse CE

CE boxes

Doppia anta

Double door

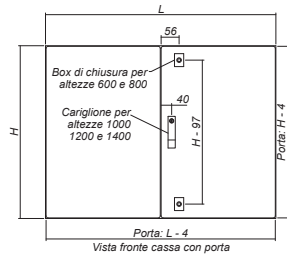

Vista fronte cassa con porta

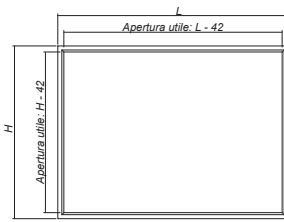

Vista fronte cassa senza porta



Vista retro cassa

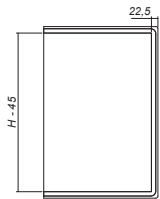

Vista interno porta sinistra

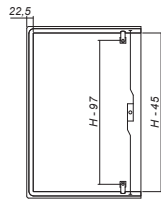

Vista interno porta destra

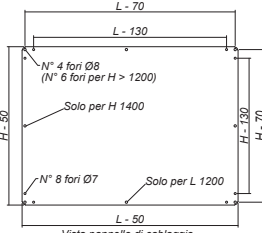

Vista pannello di cablaggio

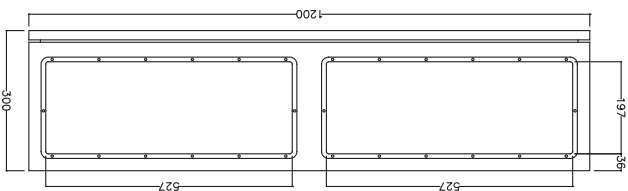
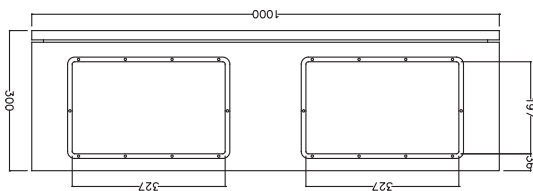
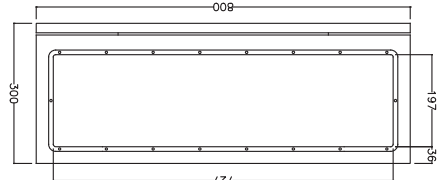
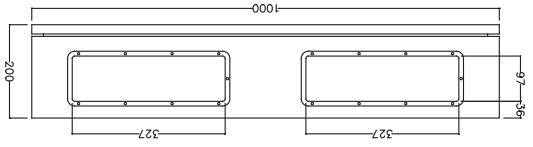
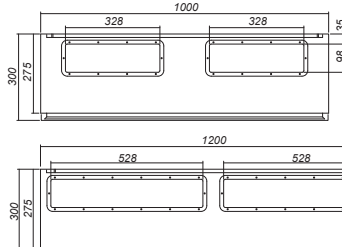
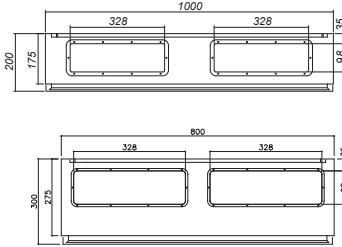

■ Casse CE CE boxes

Anta singola Single door



IP66
TYPE 4

Struttura

lamiera d'acciaio sp. 15/10 verniciata RAL 7035 bucciato.

Pannello di cablaggio

lamiera d'acciaio sp. 20/10 zincato.

Porta

reversibile, con una chiusura (due chiusure oltre altezza 500) verniciata RAL 7035 bucciato con guarnizione in colata continua.

Grado di resistenza all'urto secondo IEC EN 62208: IK10.

Piastra d'ingresso cavi

posta sul fondo della cassa adeguatamente dimensionata.

Composizione

Struttura, pannello di cablaggio, porta, piastra di ingresso cavi, confezione di viteria.

Structure

15/10 thick steel sheet, painted textured RAL 7035.

Mounting panel

20/10 thick galvanized steel.

Door

Reversible, with one locking element (two locking elements for height over 500 mm), painted textured RAL 7035, provided with a gasket applied in continuous casting.

Impact resistance degree as per IEC EN 62208: IK10.

Cable gland plate

Appropriately dimensioned and located on the box bottom.

Composition

Structure, mounting panel, door, cable gland plate, set of fasteners.

H 300

CODICE CODE	LARGHEZZA (mm) WIDTH (mm)	DIMENSIONI, MM DIMENSIONS, MM	
		PROFONDITÀ (mm) DEPTH (mm)	
R5CE0391	250	150	
R5CE0331	300	150	
R5CE0341	400	150	

H 400

CODICE CODE	LARGHEZZA (mm) WIDTH (mm)	DIMENSIONI, MM DIMENSIONS, MM	
		PROFONDITÀ (mm) DEPTH (mm)	
R5CE0431	300	150	
R5CE0432	300	200	
R5CE0442	400	200	
R5CE0462	600	200	

H 500

CODICE CODE	LARGHEZZA (mm) WIDTH (mm)	DIMENSIONI, MM DIMENSIONS, MM	
		PROFONDITÀ (mm) DEPTH (mm)	
R5CE0531	300	150	
R5CE0532	300	200	
R5CE0542	400	250	
R5CE0549	400	200	
R5CE0552	500	200	

■ Casse CE CE boxes

Anta singola Single door



H 600

CODICE CODE	LARGHEZZA (mm) WIDTH (mm)	DIMENSIONI, MM
		DIMENSIONS, MM
		PROFONDITÀ (mm) DEPTH (mm)
R5CE0642		200
R5CE0649	400	250
R5CE0644		400
R5CE0669		250
R5CE0664	600	400

H 700

CODICE CODE	LARGHEZZA (mm) WIDTH (mm)	DIMENSIONI, MM
		DIMENSIONS, MM
		PROFONDITÀ (mm) DEPTH (mm)
R5CE0752		200
R5CE0759	500	250

H 800

CODICE CODE	LARGHEZZA (mm) WIDTH (mm)	DIMENSIONI, MM
		DIMENSIONS, MM
		PROFONDITÀ (mm) DEPTH (mm)
R5CE0869		250
R5CE0863	600	300
R5CE0864		400
R5CE0883		300
R5CE0884	800	400

H 1000

CODICE CODE	LARGHEZZA (mm) WIDTH (mm)	DIMENSIONI, MM
		DIMENSIONS, MM
		PROFONDITÀ (mm) DEPTH (mm)
R5CE1069		250
R5CE1063	600	300
R5CE1064		400
R5CE1083		300
R5CE1084	800	400

H 1200

CODICE CODE	LARGHEZZA (mm) WIDTH (mm)	DIMENSIONI, MM
		DIMENSIONS, MM
		PROFONDITÀ (mm) DEPTH (mm)
R5CE1263		300
R5CE1264	600	400
R5CE1283		300
R5CE1284	800	400

H 1400

CODICE CODE	LARGHEZZA (mm) WIDTH (mm)	DIMENSIONI, MM
		DIMENSIONS, MM
		PROFONDITÀ (mm) DEPTH (mm)
R5CE1463	600	300
R5CE1483	800	

■ Casse CE CE boxes

Doppia anta Double door



IP55
TYPE12

Struttura

lamiera d'acciaio sp. 15/10 verniciata RAL 7035 bucciato.

Pannello di cablaggio

lamiera d'acciaio sp. 20/10 zincato.

Porta in due metà

reversibile, verniciata RAL 7035 bucciato con guarnizione in colata continua.

Grado di resistenza all'urto secondo IEC EN 62208: IK10.

Piastra d'ingresso cavi

posta sul fondo della cassa adeguatamente dimensionata.

Composizione

Struttura, pannello di cablaggio, porta, piastra di ingresso cavi, confezione di viteria.

Structure

15/10 thick steel sheet, painted textured RAL 7035.

Mounting panel

20/10 thick galvanized steel.

Door in two half

reversible, painted textured RAL 7035, provided with a gasket applied in continuous casting.

Impact resistance degree as per IEC EN 62208: IK10.

Cable gland plate

Appropriately dimensioned and located on the box bottom.

Composition

Structure, mounting panel, door, cable gland plate, set of fasteners.

H 600

CODICE CODE	LARGHEZZA (mm) WIDTH (mm)	DIMENSIONI, MM DIMENSIONS, MM	
		PROFONDITÀ (mm) DEPTH (mm)	
R5CE0683	800	300	
R5CE0613	1000	300	
R5CE06123	1200	300	

H 800

CODICE CODE	LARGHEZZA (mm) WIDTH (mm)	DIMENSIONI, MM DIMENSIONS, MM	
		PROFONDITÀ (mm) DEPTH (mm)	
R5CE0812	1000	200	
R5CE0813	1000	300	
R5CE08123	1200	300	

H 1000

CODICE CODE	LARGHEZZA (mm) WIDTH (mm)	DIMENSIONI, MM DIMENSIONS, MM	
		PROFONDITÀ (mm) DEPTH (mm)	
R5CE1013	1000	300	

H 1200

CODICE CODE	LARGHEZZA (mm) WIDTH (mm)	DIMENSIONI, MM DIMENSIONS, MM	
		PROFONDITÀ (mm) DEPTH (mm)	
R5CE1213	1000	300	
R5CE12123	1200	300	

H 1400

CODICE CODE	LARGHEZZA (mm) WIDTH (mm)	DIMENSIONI, MM DIMENSIONS, MM	
		PROFONDITÀ (mm) DEPTH (mm)	
R5CE1413	1000	300	

■ Casse CE CE boxes

Con porta trasparente
With transparent door



IP66

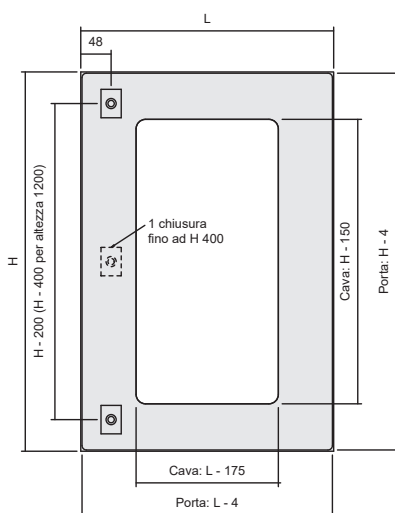

Vista fronte cassa
con porta trasparente

Struttura

lamiera d'acciaio sp. 15/10 verniciata RAL 7035 bucciato.

Pannello di cablaggio

lamiera d'acciaio sp. 20/10 zincato.

Porta

reversibile, con una chiusura (due chiusure oltre altezza 500) verniciata RAL 7035 bucciato con guarnizione in colata continua. L'apertura della porta è protetta da una lastra di vetro di sicurezza sp. 4 mm di serie.

Grado di resistenza all'urto secondo IEC EN 62208: IK09.

Piastra d'ingresso cavi

posta sul fondo della cassa adeguatamente dimensionata.

Composizione

Struttura, pannello di cablaggio, porta, piastra di ingresso cavi, confezione di viteria.

Structure

15/10 thick steel sheet, painted textured RAL 7035.

Mounting panel

20/10 thick galvanized steel.

Door

Reversible, with one locking element (two locking elements for height over 500 mm), painted textured RAL 7035, provided with a gasket applied in continuous casting. The door cutout is protected by 4 mm thick safety glass.

Impact resistance degree as per IEC EN 62208: IK09.

Cable gland plate

Appropriately dimensioned and located on the box bottom.

Composition

Structure, mounting panel, door, cable gland plate, set of fasteners.

H 400

CODICE CODE	LARGHEZZA (mm) WIDTH (mm)	DIMENSIONI, MM DIMENSIONS, MM	
		PROFONDITÀ (mm) DEPTH (mm)	
R5CEX0432	300		
R5CEX0442	400	200	
R5CEX0462	600		

H 500

CODICE CODE	LARGHEZZA (mm) WIDTH (mm)	DIMENSIONI, MM DIMENSIONS, MM	
		PROFONDITÀ (mm) DEPTH (mm)	
R5CEX0532	300	200	
R5CEX0542	400	250	
R5CEX0549	500	200	

H 600

CODICE CODE	LARGHEZZA (mm) WIDTH (mm)	DIMENSIONI, MM DIMENSIONS, MM	
		PROFONDITÀ (mm) DEPTH (mm)	
R5CEX0642	400	200	
R5CEX0649		250	
R5CEX0669	600	400	

H 700

CODICE CODE	LARGHEZZA (mm) WIDTH (mm)	DIMENSIONI, MM DIMENSIONS, MM	
		PROFONDITÀ (mm) DEPTH (mm)	
R5CEX0752		200	
R5CEX0759	500	250	

■ Casse CE CE boxes

Con porta trasparente
With transparent door



H 800

CODICE CODE	LARGHEZZA (mm) WIDTH (mm)	DIMENSIONI, MM DIMENSIONS, MM	
		PROFONDITÀ (mm) DEPTH (mm)	
R5CEX0869		250	
R5CEX0863	600	300	
R5CEX0864		400	

H 1000

CODICE CODE	LARGHEZZA (mm) WIDTH (mm)	DIMENSIONI, MM DIMENSIONS, MM	
		PROFONDITÀ (mm) DEPTH (mm)	
R5CEX1069		250	
R5CEX1063	600	300	
R5CEX1083		400	
R5CEX1084	800	300	

H 1200

CODICE CODE	LARGHEZZA (mm) WIDTH (mm)	DIMENSIONI, MM DIMENSIONS, MM	
		PROFONDITÀ (mm) DEPTH (mm)	
R5CEX1263		300	
R5CEX1264	600	400	
R5CEX1283	800	300	

■ Casse CE CE boxes

Con porta vetro serigrafato
With screen-printed glass door



IP66

Struttura

in lamiera d'acciaio sp. 15/10 verniciata RAL 7035 bucciato.

Pannello di cablaggio

in lamiera d'acciaio sp. 20/10 zincato.

Porta

reversibile con 2 chiusure, verniciata RAL 7035 bucciato con guarnizione in colata continua. L'apertura della porta è protetta da una lastra di vetro di sicurezza serigrafato e fumè.

Grado di resistenza all'urto secondo IEC EN 62208: IK09.

Piastra d'ingresso cavi

posta sul fondo della cassa adeguatamente dimensionata.

Composizione

Struttura, pannello di cablaggio, porta, piastra di ingresso cavi, confezione di viteria.

Structure

15/10 thick steel sheet, painted textured RAL 7035.

Mounting panel

20/10 thick galvanized steel.

Door

Reversible with two locking elements, painted textured RAL 7035, provided with a gasket applied in continuous casting. The door cutout is protected by a screenprinted smoked safety glass.

Impact resistance degree as per IEC EN 62208: IK09.

Cable gland plate

Appropriately dimensioned and located on the box bottom.

Composition

Structure, mounting panel, door, cable gland plate, set of fasteners.

H 600

CODICE CODE	LARGHEZZA (mm) WIDTH (mm)	DIMENSIONI, MM
		DIMENSIONS, MM
		PROFONDITÀ (mm) DEPTH (mm)
R5CEXD0662	600	200

H 800

CODICE CODE	LARGHEZZA (mm) WIDTH (mm)	DIMENSIONI, MM
		DIMENSIONS, MM
		PROFONDITÀ (mm) DEPTH (mm)
R5CEXD0862	600	200

H 1000

CODICE CODE	LARGHEZZA (mm) WIDTH (mm)	DIMENSIONI, MM
		DIMENSIONS, MM
		PROFONDITÀ (mm) DEPTH (mm)
R5CEXD1062	600	200

H 1200

CODICE CODE	LARGHEZZA (mm) WIDTH (mm)	DIMENSIONI, MM
		DIMENSIONS, MM
		PROFONDITÀ (mm) DEPTH (mm)
R5CEXD1262	600	200

■ Casse CE CE boxes

Telaio modulare completo Modular frame



Struttura

In lamiera d'acciaio di spessore 15/10 verniciata RAL 7035 bucciato. Fino alla misura 600x400 è fornito già assemblato nelle sue parti.

Structure

15/10 thick steel sheet, painted textured RAL 7035. Assembly ready to be mounted to a box until 600x400 dimension.

H 400

CODICE CODE	LARGHEZZA (mm) WIDTH (mm)	DIMENSIONI, MM DIMENSIONS, MM	TELAIO FRAME
R5TMC43	300		10 Moduli
R5TMC44	400		16 Moduli

H 500

CODICE CODE	LARGHEZZA (mm) WIDTH (mm)	DIMENSIONI, MM DIMENSIONS, MM	TELAIO FRAME
R5TMC53	300		10 Moduli
R5TMC54	400		
R5TMC55	500		21 Moduli

H 600

CODICE CODE	LARGHEZZA (mm) WIDTH (mm)	DIMENSIONI, MM DIMENSIONS, MM	TELAIO FRAME
R5TMC64	400		16 Moduli

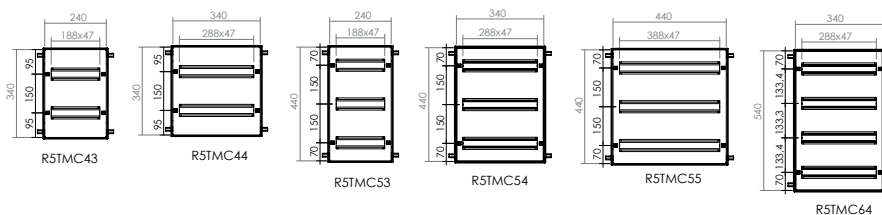

■ Casse CE

CE boxes

Telaio modulare neutro

Neutral modular frame



In lamiera d'acciaio di spessore 15/10 verniciata RAL 7035 bucciato.

Structure
15/10 thick steel sheet, painted textured RAL 7035.

H 600

CODICE CODE	LARGHEZZA (mm) WIDTH (mm)	DIMENSIONI, MM	TELAIO FRAME
		DIMENSIONS, MM	
R5TMN66	600		Modulare / Modular 600x600

H 700

CODICE CODE	LARGHEZZA (mm) WIDTH (mm)	DIMENSIONI, MM	TELAIO FRAME
		DIMENSIONS, MM	
R5TMN75	500		Modulare / Modular 700x500

H 800

CODICE CODE	LARGHEZZA (mm) WIDTH (mm)	DIMENSIONI, MM	TELAIO FRAME
		DIMENSIONS, MM	
R5TMN86	600		Modulare / Modular 800x600

H 1000

CODICE CODE	LARGHEZZA (mm) WIDTH (mm)	DIMENSIONI, MM	TELAIO FRAME
		DIMENSIONS, MM	
R5TMN106	600		Modulare / Modular 1000x600
R5TMN108			Modulare / Modular 1000x800
R5TMN128	800		Modulare / Modular 1200x800

H 1200

CODICE CODE	LARGHEZZA (mm) WIDTH (mm)	DIMENSIONI, MM	TELAIO FRAME
		DIMENSIONS, MM	
R5TMN126	600		Modulare / Modular 1200x600

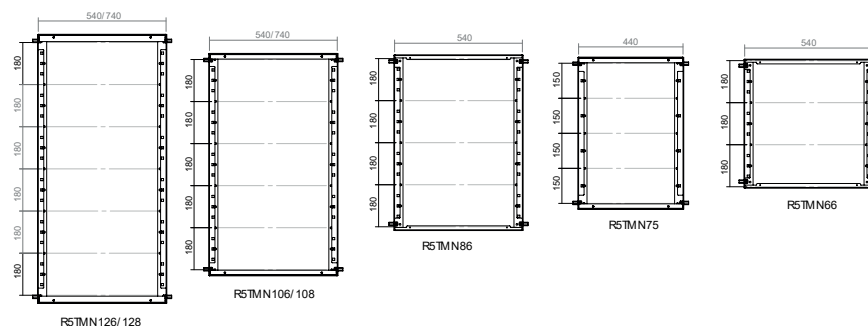

■ Casse CE CE boxes

Pannelli avvitati con guida DIN per casse CE Distribution panel DIN module for CE box



Pannelli frontali

A partire dalla misura 700x500 i pannelli frontali sono forniti sciolti in versione cieca oppure con cava DIN. In lamiera d'acciaio di spessore 15/10 verniciato RAL 7035 con fissaggio a vite. Guida DIN per ogni pannello con cava fornito di serie.

Front door

15/10 thick steel sheet, painted textured RAL 7035, grooved and fixed to the frame by means of hinges. Provided with captive screws. Each modular cut-out is complete with a DIN guide.

Composition

Structure, front door(s), mounting accessories.

H 150

CODICE CODE	DIMENSIONI, MM DIMENSIONS, MM LARGHEZZA (mm) WIDTH (mm)
R5PFC5151	500

H 180

CODICE CODE	DIMENSIONI, MM DIMENSIONS, MM LARGHEZZA (mm) WIDTH (mm)
R5PFC6181	600
R5PFC8181	800

H 300

CODICE CODE	DIMENSIONI, MM DIMENSIONS, MM LARGHEZZA (mm) WIDTH (mm)
R5PFC5301	500

H 360

CODICE CODE	DIMENSIONI, MM DIMENSIONS, MM LARGHEZZA (mm) WIDTH (mm)
R5PFC6361	600
R5PFC8361	800

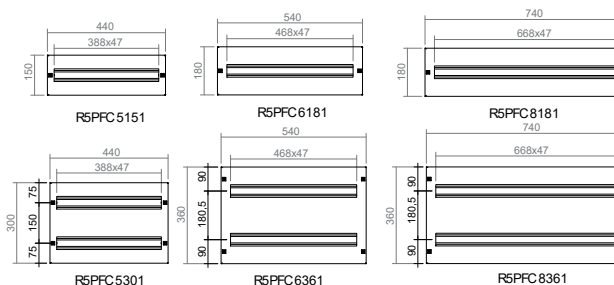

■ Casse CE CE boxes

Pannelli avvitati ciechi per casse CE Blank panel for CE box



Pannelli frontali

A partire dalla misura 700x500 i pannelli frontali sono forniti sciolti in versione cieca oppure con cava DIN. In lamiera d'acciaio di spessore 15/10 verniciato RAL 7035 con fissaggio a vite. Guida DIN per ogni pannello con cava fornito di serie.

Front door

15/10 thick steel sheet, painted textured RAL 7035, grooved and fixed to the frame by means of hinges. Provided with captive screws. Each modular cut-out is complete with a DIN guide.

Composition

Structure, front door(s), mounting accessories.

H 150

CODICE CODE	DIMENSIONI, MM DIMENSIONS, MM LARGHEZZA (mm) WIDTH (mm)
R5PFC5150	500

H 180

CODICE CODE	DIMENSIONI, MM DIMENSIONS, MM LARGHEZZA (mm) WIDTH (mm)
R5PFC6180	600
R5PFC8180	800

H 300

CODICE CODE	DIMENSIONI, MM DIMENSIONS, MM LARGHEZZA (mm) WIDTH (mm)
R5PFC5300	500

H 360

CODICE CODE	DIMENSIONI, MM DIMENSIONS, MM LARGHEZZA (mm) WIDTH (mm)
R5PFC6360	600
R5PFC8360	800

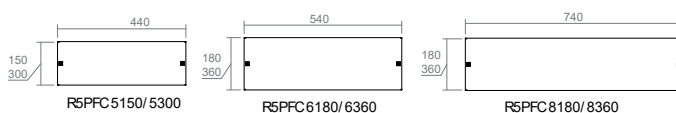

■ Casse CE CE boxes

Porta Interna per Casse CE Internal door for CE boxes



IP20

- Realizzate in lamiera d'acciaio sp. 15/10 verniciate RAL 7035.
 - Regolabili in profondità, minimo 40 mm, massimo 65 mm.
 - Dotate di un punto di chiusura (due punti oltre altezza 700 compresa).
 - Montabile su tutte le profondità.
 - Confezione da 1 pezzo completa di viteria necessaria al montaggio.
 - Montabile su casse con profondità da 150 a 400 mm.
- Manufactured of 15/10 thick steel sheet, painted RAL 7035.
 - Adjustable in depth, min. 40 mm – max. 65 mm.
 - Provided with one closing point (two closing points for height 700 and above).
 - Installable to boxes with whatever depth.
 - Pack of 1 piece complete with fasteners.
 - Mountable to boxes with the depth of 150 to 400 mm.

H 400

CODICE CODE	DIMENSIONI, MM DIMENSIONS, MM
	LARGHEZZA (mm) WIDTH (mm)
R5IE43	300
R5IE44	400
R5IE46	600

H 500

CODICE CODE	DIMENSIONI, MM DIMENSIONS, MM
	LARGHEZZA (mm) WIDTH (mm)
R5IE53	300
R5IE54	400
R5IE55	500

H 600

CODICE CODE	DIMENSIONI, MM DIMENSIONS, MM
	LARGHEZZA (mm) WIDTH (mm)
R5IE64	400
R5IE66	600

H 700

CODICE CODE	DIMENSIONI, MM DIMENSIONS, MM
	LARGHEZZA (mm) WIDTH (mm)
R5IE75	500

H 800

CODICE CODE	DIMENSIONI, MM DIMENSIONS, MM
	LARGHEZZA (mm) WIDTH (mm)
R5IE86	600

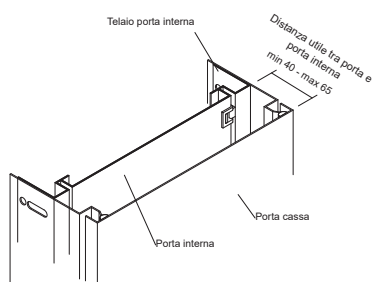
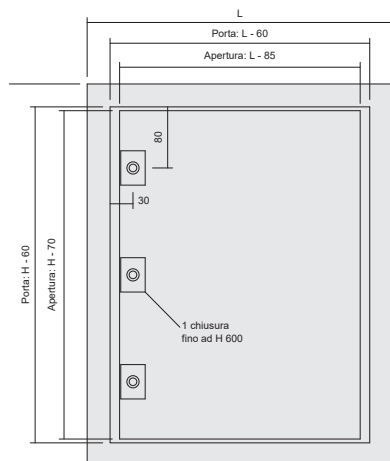

■ Casse CE CE boxes

Porta Interna per Casse CE Internal door for CE boxes



H 1000

CODICE CODE	DIMENSIONI, MM DIMENSIONS, MM LARGHEZZA (mm) WIDTH (mm)
R5IE16	600
R5IE18	800

H 1200

CODICE CODE	DIMENSIONI, MM DIMENSIONS, MM LARGHEZZA (mm) WIDTH (mm)
R5IE26	600
R5IE28	800

Tetto di protezione Protective canopy for box

Tetto di protezione realizzato in lamiera d'acciaio sp. 15/10 verniciato con polveri epossipoliesteri RAL 7035 bucciato. Confezione da 1 pezzo completa di viteria necessaria per il montaggio. Altre dimensioni disponibili a richiesta

Protective canopy. Manufactured of 15/10 thick sheet steel, painted textured RAL 7035 with epoxy-polyester powders. Pack of 1 piece complete with fasteners necessary for mounting. Other sizes available on request.



CODICE CODE	LARGHEZZA (mm) WIDTH (mm)	DIMENSIONI, MM DIMENSIONS, MM PROFONDITÀ (mm) DEPTH (mm)
R5TT042	400	200
R5TT049		250
R5TT052	500	200
R5TT059		250
R5TT069	600	
R5TT063		300
R5TT083	800	
R5TT084		400

■ Casse CE CE boxes

Guide di rinforzo porta Reinforcement rails for doors



- Realizzate in lamiera d'acciaio sp. 15/10 zincata sendzimir.
- Fori da 4,2 mm a passo 25 mm.
- Confezione completa di viteria per il montaggio.

- Made of 15/10 thick Sendzimir galvanized steel.
- 4.2 mm holes with 25 mm pitch.
- Complete with accessories and screws for assembly.

H 500

CODICE CODE	DIMENSIONI, MM DIMENSIONS, MM CONFEZIONI/PZ PACK/PCS
RZS50	2

H 600

CODICE CODE	DIMENSIONI, MM DIMENSIONS, MM CONFEZIONI/PZ PACK/PCS
RZS60	2

H 700

CODICE CODE	DIMENSIONI, MM DIMENSIONS, MM CONFEZIONI/PZ PACK/PCS
RZS70	2

H 800

CODICE CODE	DIMENSIONI, MM DIMENSIONS, MM CONFEZIONI/PZ PACK/PCS
RZS80	2

H 1000

CODICE CODE	DIMENSIONI, MM DIMENSIONS, MM CONFEZIONI/PZ PACK/PCS
RZS100	2

H 1200

CODICE CODE	DIMENSIONI, MM DIMENSIONS, MM CONFEZIONI/PZ PACK/PCS
RZS120	2

H 1400

CODICE CODE	DIMENSIONI, MM DIMENSIONS, MM CONFEZIONI/PZ PACK/PCS
RZS140	2

■ Casse CE CE boxes

Telaio rack girevole Rotating 19 inch rack



- Telaio e portella rack da 19" in lamiera d'acciaio sp. 15/10 verniciata RAL 7035 bucciato.
- Fissaggio con 2 punti di chiusura.
- Massima apertura pari a 110° circa.
- Profondità massima dei cassetti rack da 19" pari 215 mm.
- Profondità regolabile da 40 a 60 mm massimo.
- Montabile solo su casse con larghezza pari a 600 mm e profondità pari a 300 e 400 mm.
- Confezione da 1 pezzo completa di viteria per il montaggio.
- 19" Rack and door of 15/10 thick steel sheet, painted textured RAL 7035.
- Fixed with 2 closing points.
- Max. opening of 110° approximately.
- 19" rack drawers max. depth 215 mm.
- Adjustable mounting depth: 40 to 60 mm.
- Applicable only to boxes with the width of 600 mm and depth of 300 and 400 mm.
- Pack of 1 piece complete with accessories and screws for assembly.

H 400

CODICE CODE	LARGHEZZA (mm) WIDTH (mm)	DIMENSIONI, MM DIMENSIONS, MM		
		PROFONDITÀ (mm) DEPTH (mm)	A A	ALTEZZA HE HE HEIGHT
R5TIE460	600	300	135	3
R5TIE461			268	6

H 600

CODICE CODE	LARGHEZZA (mm) WIDTH (mm)	DIMENSIONI, MM DIMENSIONS, MM		
		PROFONDITÀ (mm) DEPTH (mm)	A A	ALTEZZA HE HE HEIGHT
R5TIE660	600	400	402	9

H 800

CODICE CODE	LARGHEZZA (mm) WIDTH (mm)	DIMENSIONI, MM DIMENSIONS, MM		
		PROFONDITÀ (mm) DEPTH (mm)	A A	ALTEZZA HE HE HEIGHT
R5TIE860	600	300-400	535	12
R5TIE861			668	15

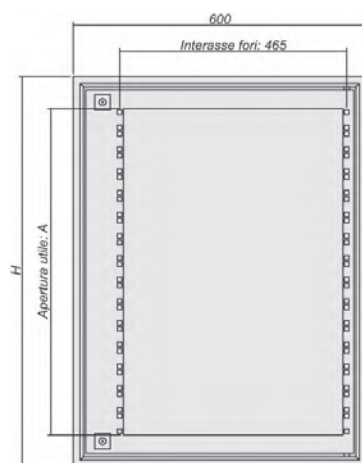

Vista fronte cassa con telaio rack 19"

■ Casse CE CE boxes

Blocco porta Door stop



- Realizzato in lamiera d'acciaio zincato sp. 20/10.
- Studiato per impedire la chiusura accidentale della porta bloccandone l'apertura a 90°.
- Confezione da 1 pezzo completa di accessori per il montaggio.

- Made of 20/10 thick Sendzimir galvanized steel.
- Designed to prevent accidental door closing by blocking it in opened position at 90°.
- Pack of 1 piece complete with mounting accessories.

	CODICE CODE	DIMENSIONI, MM DIMENSIONS, MM CONFEZIONI/PZ PACK/PCS
	RZA31	1

Chiusura a box Box lock



** Inserto da montare in sostituzione agli inserti standard (doppio pettine Ø 3 mm) .

** Insert to be mounted instead of standard inserts (double-bit Ø 3 mm).

CHIUSURA LOCKING	CODICE CODE			DESCRIZIONE DESCRIPTION
	RPCE205			Chiusura completa di inserto tipo aletta doppio pettine Ø 3 mm Locking element complete with double-bit lock insert Ø 3 mm
CODICE CODE				
INSERTO INSERT	CHIAVE IN PLASTICA PLASTIC KEY	INSERTO INSERT	DESCRIZIONE DESCRIPTION	
	RPCE240	RZCE261	Aletta doppio pettine Ø 3 mm Double-bit lock insert Ø 3 mm	
	RPCE246	RZCE224	Triangolo 8 mm Triangle 8 mm	
	RPCE245	RZCE223	Triangolo 7 mm Triangle 7 mm	
	RZCE237*	RZCE226	Tipo FIAT FIAT type	
	RPCE243	RZCE221	Quadro 7 mm Square 7 mm	
		RZCE227**	Chiusura completa (con chiavi uguali) Complete lock (with equal keys)	
		RZCE228**	Chiusura completa (con chiavi uguali) Complete lock (with equal keys)	





* chiave in metallo
* metal key

■ Casse CE CE boxes

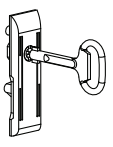
Chiusura a cariglione Ratchet lock



CHIUSURA LOCKING	CODICE CODE	DESCRIZIONE DESCRIPTION
	RZCE200	Chiusura completa di inserto tipo aletta doppio pettine Ø 3 mm Locking element complete with double-bit lock insert Ø 3 mm

CODICE CODE		DESCRIZIONE DESCRIPTION
INSERTO INSERT	CHIAVE IN PLASTICA PLASTIC KEY	INSERTO INSERT
	RZCE230	RZCE219 Aletta doppio pettine Ø 3 mm Double-bit lock insert Ø 3 mm
	RZCE236	RZCE214 Triangolo 8 mm Triangle 8 mm
	RZCE235	RZCE213 Triangolo 7 mm Triangle 7 mm
	RZCE234	RZCE212 Quadro 8 mm Square 8 mm
	RZCE233	RZCE211 Quadro 7 mm Square 7 mm

** Inserto da montare in sostituzione agli inserti standard (doppio pettine Ø 3 mm) .

** Insert to be mounted instead of standard inserts (double-bit Ø 3 mm).

■ Casse CE CE boxes

Zoccolo completo

Complete plinth H100 mm for CE Boxes



- Per aumentare le possibilit. di installazione delle casse CE, DKC propone la possibilit. di utilizzare lo zoccolo per installazione a terra.
- Tale zoccolo realizzato abbinando flangia frontale e laterale avr. un'altezza di 100mm.
- Flangia frontale e laterale sono realizzate in lamiera d'acciaio sp. 20/10 verniciata RAL7011 bucciato, complete di viteria per il montaggio.
- Questo accessorio. disponibile per un totale di sei dimensioni, a partire dalla larghezza di 600mm.

- To increase the installation possibilities of the CE enclosures, DKC recommends the possibility of using the plinth for ground installation.
- This baseboard made by combining front and side flange will have a height of 100mm.
- Front and side flanges are made of 20/10 thick steel sheet, painted with RAL7011 textured finish, complete with screws for assembly.
- This accessory is available in a total of six sizes, starting from a width of 600mm.

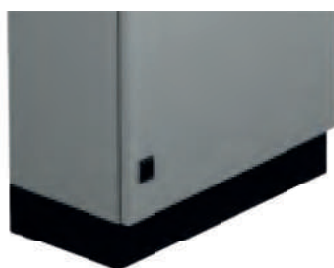

DIMENSIONI CASSA BOX DIMENSIONS mm

FLANGIA FRONTALE FRONT FLANGE

FLANGIA LATERALE SIDE FLANGE

DIMENSIONI CASSA BOX DIMENSIONS mm	FLANGIA FRONTALE FRONT FLANGE		FLANGIA LATERALE SIDE FLANGE
600X300	R1FZCE6	+	R1LZCE3
600X400	R1FZCE6	+	R1LZCE4
800X300	R1FZCE8	+	R1LZCE3
800X400	R1FZCE8	+	R1LZCE4
1000X300	R1FZCE10	+	R1LZCE3
1200X300	R1FZCE12	+	R1LZCE3

■ Casse CE CE boxes

Staffa Fissaggio universale Universal fixing bracket



- Realizzate in lamiera d'acciaio sp. 25/10 zincate Magnelis®.
- Particolarmente indicate per il fissaggio della cassa a parete.
- Confezione da 4 pezzi compresa di viteria per il montaggio.

- Manufactured of 25/10 thick Magnelis® galvanized steel.
- Particularly suitable for wall-mounting of heavy-duty boxes.
- Pack of 4 pieces complete with accessories and screws for assembly.

CODICE CODE	DIMENSIONI, MM DIMENSIONS, MM CARICO MAX MAX LOAD
RZA62	4x100

Kit Antisismico Casse CE Anti-seismic Kit CE Boxes



Kit antisismico casse CE

Anti-seismic Kit CE Boxes

CODICE CODE	LARGHEZZA (mm) WIDTH (mm)	DIMENSIONI, MM DIMENSIONS, MM PROFONDITÀ (mm) DEPTH (mm)
RAKASCE600	800	600
RAKASCE800		800



Casse di derivazione CDE
CDE junction boxes

■ Casse di derivazione CDE

CDE junction boxes

Per installazione INDOOR
For INDOOR installation

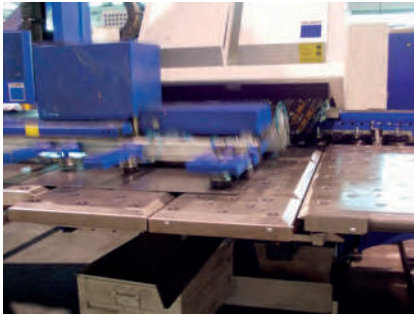

Struttura

Struttura in lamiera d'acciaio spessore 10/10 con saldatura continua sulle giunzioni.

Dotata di serie di guide forate a passo 25mm elettrosaldate per il fissaggio degli accessori.

Quattro fori sulla parte posteriore permettono il fissaggio a parete, diretto oppure tramite apposite staffe (codice RZA62).

Casse disponibili in tre differenti versioni: cieche, cieche con flange ingresso cavi oppure con coperchio incernierato.



Porte

Porte cieche avvitate dotate di adeguati punti di fissaggio.

Dotate di guarnizione poliuretanica posata in colata continua.

La verniciatura viene eseguita di serie con polveri epossipoliestere, colore standard RAL 7035.

Il ciclo di verniciatura standard applicato è classificabile, secondo la norma UNI ISO 12944-2018, come C3 con durabilità M.

Il grado di protezione delle casse CDE in esecuzione coperchio avvitato e senza flange è IP66. In esecuzione con porta incernierata è IP55. In versione con flange è IP55.



Structure

10/10 sheet steel structure with continuous welding on the joints.

Equipped as standard with perforated guides with 25mm pitch welded for fixing accessories.

Four holes on the rear allow for wall mounting, either directly or through special brackets (code RZA62).

Cases available in three different versions: blind, blind with cable entry flanges or with hinged lid.

Doors

Blind screwed doors equipped with suitable fixing points.

Equipped with polyurethane gasket laid in continuous casting.

The painting is carried out as standard with epoxy-polyester powders, standard color RAL 7035.

The applied standard painting cycle can be classified, according to UNI ISO 12944-2018, as C3 with durability M.

The degree of protection of CDE enclosures in screwed and flange-free cover execution is IP66. In execution with hinged door it is IP55. In version with flanges it is IP55.

■ Casse di derivazione CDE CDE junction boxes

Caratteristiche Tecniche Technical characteristics

Conformità e omologazioni Conformity and approvals



Grado di protezione

- Casse cieche con coperchio avvitato **IP 66** in accordo con IEC EN 62208; EN 60529
- Casse con flange o porta incernierata **IP 55** in accordo con IEC EN 62208; EN 60529
- **TYPE 4/12** (a seconda della versione) in accordo con UL508A; UL50
- Grado di protezione garantito dalla guarnizione in schiuma poliuretana bi-componente
- Grado di resistenza all'urto **IK10** in accordo con IEC EN 62208; EN 50102

Protection degree

- Blind enclosures with screwed cover **IP 66** in accordance with IEC EN 62208; EN 60529
- Boxes with flanges or hinged door **IP 55** in accordance with IEC EN 62208; EN 60529
- **TYPE 4** (depending on the version) in accordance with UL508A; UL50
- The protection degree is guaranteed by a two-component polyurethane foam seal
- Impact resistance degree **IK10** according to IEC EN 62208; EN 50102

Struttura in lamiera d'acciaio.
Structure made of steel sheet.

Disponibili due versioni: senza o con flange asportabili per l'ingresso cavi.
Available in two versions: with or without flanges with removable blanking plates.

Fissaggio diretto a parete oppure mediante staffe (opzionali).
Direct mounting to a wall or by means of brackets (optional)

Guide elettrosaldate forate a passo 25 mm per il fissaggio degli accessori di completamento.
Electrically welded guides perforated with 25 mm pitch purposed for accessories mounting

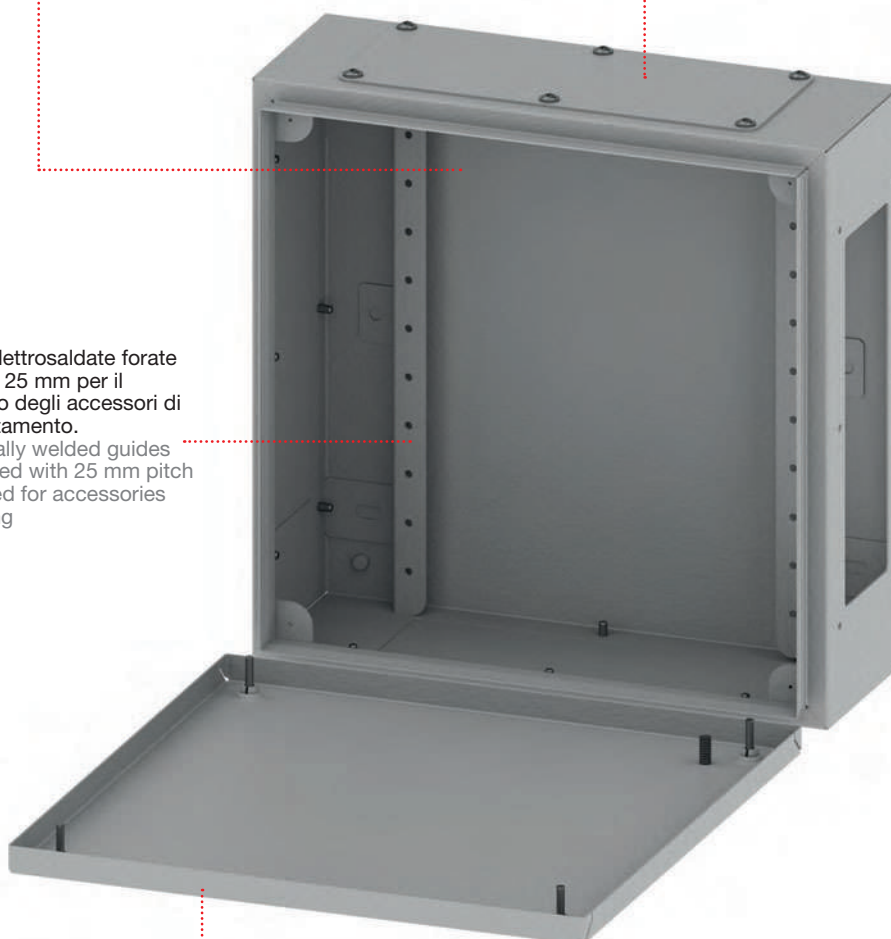

Coperchio avvitato o incernierato in base al modello scelto.
Screwed or hinged cover depending on the chosen model

■ Casse di derivazione CDE CE junction boxes

Cassa di derivazione con coperchio avvitato Junction boxes with screwed cover



IP66
TYPE 4

Struttura

lamiera d'acciaio sp. 10/10 verniciata RAL7035 bucciato.

Coperchio o porta incernierata

verniciati RAL 7035 bucciato con guarnizione in colata continua.

Composizione

Struttura, porta o coperchio, confezione di viteria.

Grado di resistenza meccanica

IK10 secondo IEC EN 62208

Structure

10/10 thick steel sheet, painted textured RAL 7035.

Cover or hinged door

Painted textured RAL 7035, provided with a gasket applied in continuous casting.

Composition

Structure, door or cover, set of accessories and screws for assembly.

Mechanical resistance degree

IK10 as per IEC EN 62208

H 150

CODICE CODE	LARGHEZZA (mm) WIDTH (mm)	DIMENSIONI, MM
		DIMENSIONS, MM
		PROFONDITÀ (mm) DEPTH (mm)
R5CDE1180	150	80
R5CDE1120		120

H 180

CODICE CODE	LARGHEZZA (mm) WIDTH (mm)	DIMENSIONI, MM
		DIMENSIONS, MM
		PROFONDITÀ (mm) DEPTH (mm)
R5CDE9180	150	80

H 200

CODICE CODE	LARGHEZZA (mm) WIDTH (mm)	DIMENSIONI, MM
		DIMENSIONS, MM
		PROFONDITÀ (mm) DEPTH (mm)
R5CDE2980	180	80
R5CDE2280		120
R5CDE22120	200	120

H 300

CODICE CODE	LARGHEZZA (mm) WIDTH (mm)	DIMENSIONI, MM
		DIMENSIONS, MM
		PROFONDITÀ (mm) DEPTH (mm)
R5CDE3180	150	80
R5CDE31120		120
R5CDE3280		80
R5CDE32120	200	120
R5CDE33120	300	120

H 400

CODICE CODE	LARGHEZZA (mm) WIDTH (mm)	DIMENSIONI, MM
		DIMENSIONS, MM
		PROFONDITÀ (mm) DEPTH (mm)
R5CDE4280	200	80
R5CDE42120		120
R5CDE43120	300	120
R5CDE44120	400	120

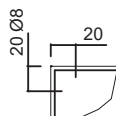
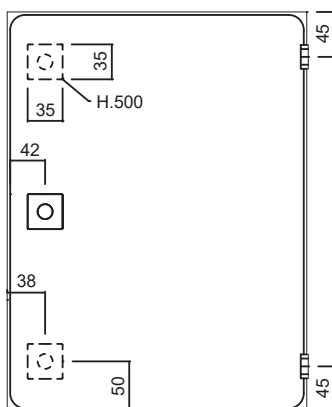

■ Casse di derivazione CDE CE junction boxes

Cassa di derivazione con coperchio avvitato
Junction boxes with screwed cover



H 500

CODICE CODE	LARGHEZZA (mm) WIDTH (mm)	DIMENSIONI, MM DIMENSIONS, MM	
		PROFONDITÀ (mm) DEPTH (mm)	
R5CDE52120	200	120	
R5CDE53120	300	120	

H 600

CODICE CODE	LARGHEZZA (mm) WIDTH (mm)	DIMENSIONI, MM DIMENSIONS, MM	
		PROFONDITÀ (mm) DEPTH (mm)	
R5CDE6280	200	80	
R5CDE62120	300	120	
R5CDE63120	400	120	

H 800

CODICE CODE	LARGHEZZA (mm) WIDTH (mm)	DIMENSIONI, MM DIMENSIONS, MM	
		PROFONDITÀ (mm) DEPTH (mm)	
R5CDE8280	200	80	
R5CDE82120	300	120	
R5CDE84120	400	120	

■ Casse di derivazione CDE

CE junction boxes

Cassa di derivazione con coperchio incernierato

Junction boxes with hinged door



IP55
TYPE 12

Struttura

Lamiera d'acciaio sp. 10/10 verniciata RAL7035 bucciato.

Coperchio o porta incernierata

Verniciati RAL 7035 bucciato con guarnizione in colata continua.

Composizione

Struttura, porta o coperchio, confezione di viteria.

Grado di resistenza meccanica

IK10 secondo IEC EN 62208

Structure

10/10 thick steel sheet, painted textured RAL 7035.

Cover or hinged door

Painted textured RAL 7035, provided with a gasket applied in continuous casting.

Composition

Structure, door or cover, set of accessories and screws for assembly.

Mechanical resistance degree

IK10 as per IEC EN 62208

H 200

CODICE CODE	LARGHEZZA (mm) WIDTH (mm)	DIMENSIONI, MM DIMENSIONS, MM
		PROFONDITÀ (mm) DEPTH (mm)
R5CDE2280C	200	80
R5CDE22120C		120

H 300

CODICE CODE	LARGHEZZA (mm) WIDTH (mm)	DIMENSIONI, MM DIMENSIONS, MM
		PROFONDITÀ (mm) DEPTH (mm)
R5CDE3280C	200	80
R5CDE32120C		120
R5CDE33120C	300	

H 400

CODICE CODE	LARGHEZZA (mm) WIDTH (mm)	DIMENSIONI, MM DIMENSIONS, MM
		PROFONDITÀ (mm) DEPTH (mm)
R5CDE4280C	200	80
R5CDE42120C		120
R5CDE43120C	300	

H 500

CODICE CODE	LARGHEZZA (mm) WIDTH (mm)	DIMENSIONI, MM DIMENSIONS, MM
		PROFONDITÀ (mm) DEPTH (mm)
R5CDE52120C	200	120

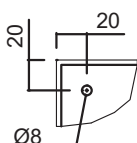
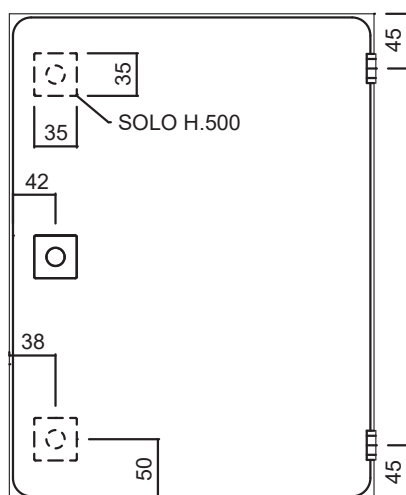

■ Casse di derivazione CDE

CE junction boxes

Cassa di derivazione con flange

Junction boxes with flanges



IP55
TYPE 12

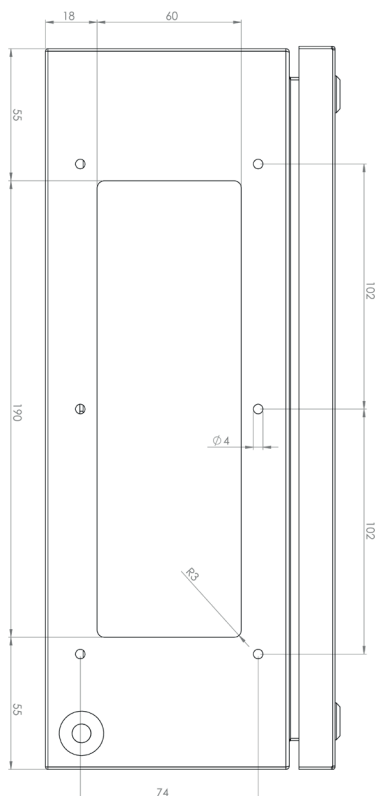

Struttura

Lamiera d'acciaio sp. 10/10 verniciata RAL7035 bucciato.

Porta

Verniciati RAL 7035 bucciato con guarnizione in colata continua.

Composizione

Struttura, porta, confezione di viteria.

Grado di resistenza meccanica

IK10 secondo IEC EN 62208

Structure

10/10 thick sheet steel, painted textured RAL 7035.

Door

Painted textured RAL 7035, provided with a gasket applied in continuous casting.

Composition

Structure, door, set of accessories and screws for assembly.

Mechanical resistance degree

IK10 as per IEC EN 62208

H 300

CODICE C.CODE	LARGHEZZA (mm) WIDTH (mm)	DIMENSIONI, MM DIMENSIONS, MM	
		PROFONDITÀ (mm) DEPTH (mm)	FLANGE FLANGE
R5CDE32120F	200	120	2 lato 300
R5CDE33120F	300		4 su tutti i lati

H 400

CODICE C.CODE	LARGHEZZA (mm) WIDTH (mm)	DIMENSIONI, MM DIMENSIONS, MM	
		PROFONDITÀ (mm) DEPTH (mm)	FLANGE FLANGE
R5CDE42120F	200		2 lato 400
R5CDE43120F	300	120	
R5CDE44120F	400		4 su tutti i lati

H 500

CODICE C.CODE	LARGHEZZA (mm) WIDTH (mm)	DIMENSIONI, MM DIMENSIONS, MM	
		PROFONDITÀ (mm) DEPTH (mm)	FLANGE FLANGE
R5CDE52120F	200	120	2+2 lato 500
R5CDE53120F	300		2+2 lato 500 (N1+1) lato 300

H 600

CODICE C.CODE	LARGHEZZA (mm) WIDTH (mm)	DIMENSIONI, MM DIMENSIONS, MM	
		PROFONDITÀ (mm) DEPTH (mm)	FLANGE FLANGE
R5CDE62120F	200		2+2 L600
R5CDE63120F	300	120	2+2 lato 600 (N1+1) lato 300
R5CDE64120F	400		2+2 lato 600 (N1+1) lato 400

H 800

CODICE C.CODE	LARGHEZZA (mm) WIDTH (mm)	DIMENSIONI, MM DIMENSIONS, MM	
		PROFONDITÀ (mm) DEPTH (mm)	FLANGE FLANGE
R5CDE82120F	200	120	3+3 lato 800
R5CDE84120F	400		3+3 lato 800 (N1+1) lato 400

■ Casse di derivazione CDE CE junction boxes

Profili DIN DIN Profiles



- Fissaggio sui traversini delle casse.
- Confezione da 10 pezzi.
- Completa di accessori per il montaggio.
- Mountable onto box rails.
- Pack of 10 pieces.
- Complete with mounting accessories.

CODICE CODE	DIMENSIONI, MM DIMENSIONS, MM LARGHEZZA (mm) WIDTH (mm)
RZCDO15	150
RZCDO18	180
RZCDO20	200
RZCDO30	300
RZCDO40	400
RZCDO50	500
RZCDO60	600
RZCDO80	800

Staffa Fissaggio universale Universal fixing bracket



- Realizzate in lamiera d'acciaio sp. 25/10 zincate Magnelis®.
- Particolarmente indicate per il fissaggio della cassa a parete.
- Confezione da 4 pezzi compresa di viteria per il montaggio.
- Manufactured of 25/10 thick Magnelis® galvanized steel.
- Particularly suitable for wall-mounting of heavy-duty boxes.
- Pack of 4 pieces complete with accessories and screws for assembly.

CODICE CODE	DIMENSIONI, MM DIMENSIONS, MM CARICO MAX MAX LOAD
RZA62	4x100

■ Casse di derivazione CDE CE junction boxes

Cerniera per casse di derivazione Hinges for junction box covers



Cerniera realizzata in zama pressofusa.
Permettono di trasformare il coperchio
avvitato in incernierato.
Confezione da 6 pezzi completa di viteria
per il montaggio.
Casse declassate a IP55.

Hinges manufactured of die-cast zamak.
Allow to transform a screwed cover into a
hinged one.
Pack of 6 pieces complete with
accessories and screws for assembly.
Downgraded boxes to IP55.

CODICE CODE	DIMENSIONI, MM DIMENSIONS, MM CONFEZIONI/PZ PACK/PCS
RZCDA02	6

■ Casse di derivazione CDE CE junction boxes

Piastra interna per casse di derivazione Internal plate for CDE junction boxes

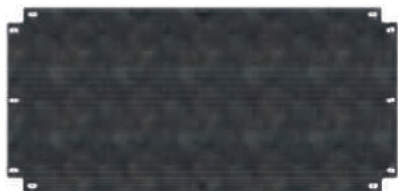

- Realizzata in lamiera d'acciaio zincata sendzimir sp. 20/10.
- Fissata all'involucro tramite i traversini già presenti all'interno della cassa.
- Completa di accessori per il montaggio.

- Manufactured of 20/10 Sendzimir galvanized steel.
- Fixed to the enclosure by means of mounting bars provided inside the box.
- Complete with mounting accessories.

H 150

CODICE CODE	DIMENSIONI, MM DIMENSIONS, MM LARGHEZZA (mm) WIDTH (mm)
RZCDP11	150

H 180

CODICE CODE	DIMENSIONI, MM DIMENSIONS, MM LARGHEZZA (mm) WIDTH (mm)
RZCDP91	150
RZCDP29	180

H 200

CODICE CODE	DIMENSIONI, MM DIMENSIONS, MM LARGHEZZA (mm) WIDTH (mm)
RZCDP22	200

H 300

CODICE CODE	DIMENSIONI, MM DIMENSIONS, MM LARGHEZZA (mm) WIDTH (mm)
RZCDP31	150
RZCDP32	200
RZCDP33	300

H 400

CODICE CODE	DIMENSIONI, MM DIMENSIONS, MM LARGHEZZA (mm) WIDTH (mm)
RZCDP42	200
RZCDP43	300
RZCDP44	400

H 500

CODICE CODE	DIMENSIONI, MM DIMENSIONS, MM LARGHEZZA (mm) WIDTH (mm)
RZCDP52	200
RZCDP53	300

H 600

CODICE CODE	DIMENSIONI, MM DIMENSIONS, MM LARGHEZZA (mm) WIDTH (mm)
RZCDP62	200
RZCDP63	300
RZCDP64	400

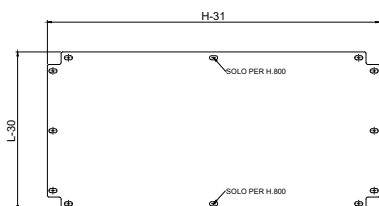

■ Casse di derivazione CDE CE junction boxes

Piastra interna per casse di derivazione
Internal plate for CDE junction boxes

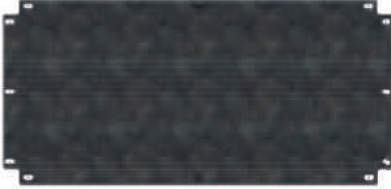

H 800

CODICE CODE	DIMENSIONI, MM DIMENSIONS, MM LARGHEZZA (mm) WIDTH (mm)
RZCDP82	200
RZCDP84	400



Casse in acciaio inox Serie CE e CDE
CE and CDE series stainless steel boxes

■ Casse in acciaio inox Serie CE e CDE CE and CDE series stainless steel boxes

Caratteristiche Generali General characteristics



La gamma di carpenterie Ramblock si amplia con due nuove linee: cassette in acciaio inox AISI 304 e 316 gestite a richiesta serie CE e CDE. L'acciaio inox è particolarmente indicato in tutti quei settori in cui è richiesto un elevato standard igienico e di resistenza alla corrosione (alimentare, chimico farmaceutico, ospedaliero).

Assortimento

DKC propone una vasta gamma di prodotti che comprende casse in acciaio inox con porta cieca a singola anta, porta cieca a doppia anta, coperchio avvitato e accessori. Gli accessori (piastre interne, staffe di fissaggio, profili DIN, guide di rinforzo porta, box di chiusura) comprendono sia prodotti in acciaio inox che codici standard presenti sul catalogo. Le casse RICE sono fornite complete di pannello di cablaggio zincato e di porta a singola o doppia anta. Non presentano flange di ingresso cavi. Le casse di derivazione RICDE sono fornite con coperchio avvitato.

Le casse possono essere installate a parete, tramite le apposite staffe, da ordinare separatamente, oppure fissate a pavimento.

Caratteristiche

Tutta la gamma di casse in acciaio inox soddisfano elevati gradi di protezione (IP66/IP55 in accordo con IEC EN 62208; EN 60529. Type 4X / Type 12 in accordo con UL508A; UL50) e di resistenza all'urto (IK10 secondo IEC EN 62208). L'alto grado di protezione consente di installare le casse in acciaio inox in ambienti caratterizzati da condizioni gravose. Queste caratteristiche rispondono alle esigenze delle installazioni in settori come il chimico-farmaceutico, l'alimentare e l'ospedaliero. Laddove è ricercata la massima igiene, la più alta resistenza alla corrosione e alle variazioni di temperatura, le casse inox Ramblock diventano la soluzione ideale. Le casse inox possono essere installate anche all'esterno.

Facilità di installazione

Tutte le casse sono fornite comprensive di viteria per il montaggio.

The Ramblock range of structural work is extended with two new lines: AISI 304 and AISI 316 stainless steel boxes, CE and CDE series. Stainless steel is particularly suitable in all those sectors where a high standard of hygiene and corrosion resistance is required (food, chemical pharmaceutical, hospital).

Assortment

DKC offers a wide range of products including stainless steel boxes with single-leaf blank door, double-leaf blank door, screwed on cover and accessories. The accessories (internal partitions, fixing brackets, DIN profiles, door reinforcement guides, closure boxes) include both stainless steel products and standard codes found in the catalogue. RICE boxes are supplied complete with galvanized wiring panel and single or double leaf door. They do not have cable entry flanges. The RICDE junction boxes are supplied with a screwed on cover.

The boxes can be wall mounted, using the appropriate brackets, to be ordered separately, or fastened to the floor.

Characteristics

The whole range of stainless steel boxes have high protection ratings (IP66 / IP55 according to IEC EN 62208; EN 60529). TYPE 4X / TYPE 12 according to UL508A; UL50) and impact resistance (IK10 according to IEC EN 62208). This high degree of protection means our stainless steel boxes can be installed in environments with harsh conditions. These characteristics meet the needs of installations in, for example, the chemical-pharmaceutical, food and hospital sectors. Where maximum hygiene, the highest resistance to corrosion and temperature variations are required, Ramblock stainless steel boxes are the ideal solution. The stainless steel boxes can also be installed outdoors.

Easy to install

All the boxes are supplied including assembly fasteners.



■ Casse in acciaio inox Serie CE e CDE CE and CDE series stainless steel boxes

Caratteristiche Tecniche Technical characteristics

Conformità e omologazioni Conformity and approvals

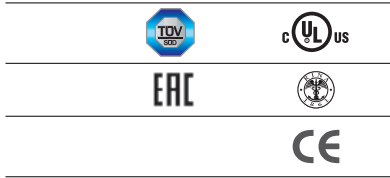

- **IP 55** in accordo con IEC EN 62208; EN 60529
- **TYPE 4X** in accordo con UL508A; UL50 (singola anta cieca)
- **TYPE 12** in accordo con UL508A; UL50 (doppia anta cieca)
- Grado di protezione garantito dalla guarnizione in schiuma poliuretana bi-componente
- Grado di resistenza all'urto **IK10** in accordo con IEC EN 62208; EN 50102

Protection degree

- **IP 55** according to IEC EN 62208; EN 60529
- **TYPE 4** according to UL508A; UL50 (single blind door)
- **TYPE 12** according to UL508A; UL50 (double blind door)
- The protection degree is guaranteed by a seal of two-component polyurethane foam
- Impact resistance degree **IK10** according to IEC EN 62208; EN 50102



■ Casse in acciaio inox Serie CE e CDE

CE and CDE series stainless steel boxes

Anta singola

Single door

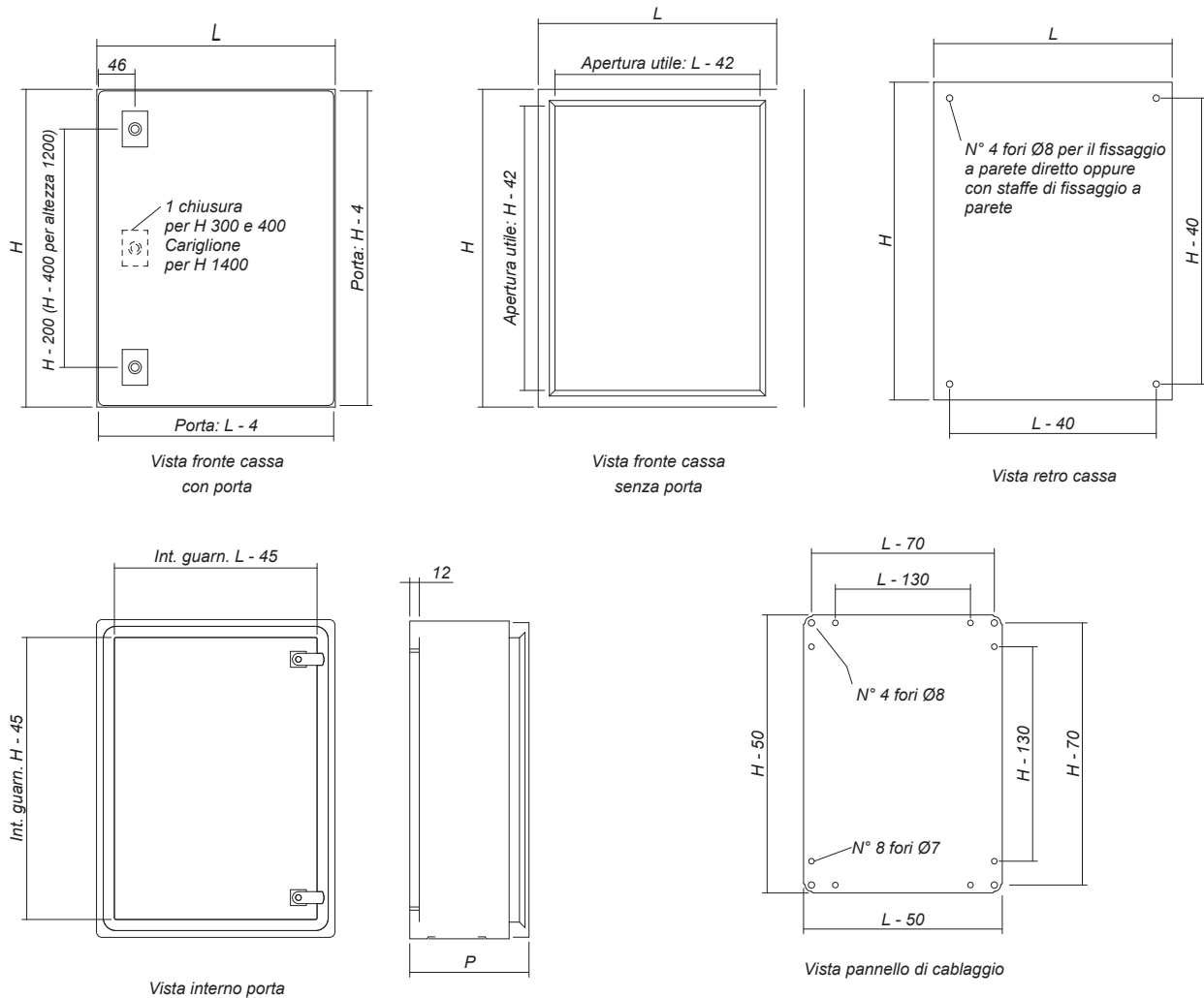

■ Casse in acciaio inox Serie CE e CDE

CE and CDE series stainless steel boxes

Doppia anta

Double door

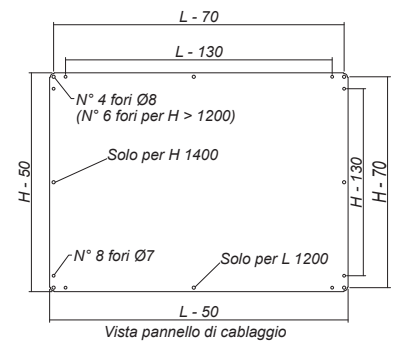
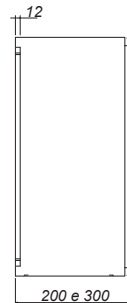
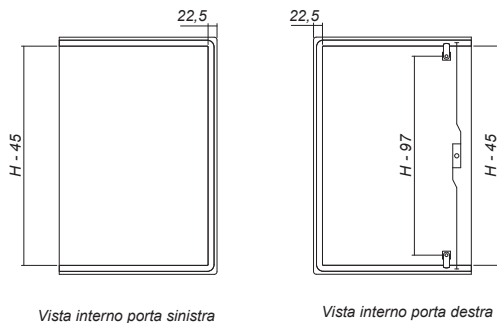
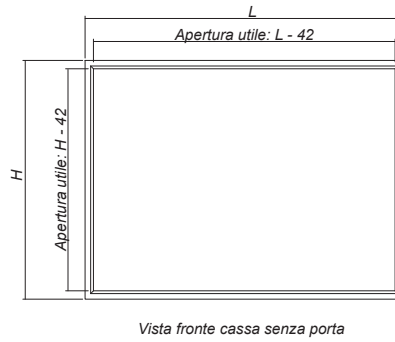
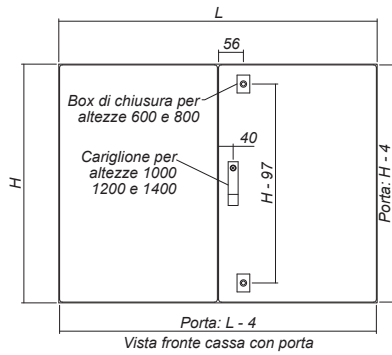

■ Casse INOX

Stainless steel CE boxes

Casse serie CE Inox - Anta singola

Stainless steel CE Box - Single door



IP66

Struttura

Acciaio inox AISI 304 sp. 12/10 - 15/10 (su richiesta AISI 316). Senza flange ingresso cavi.

Pannello di cablaggio

Lamiera d'acciaio sp. 20/10 zincato.

Porta

Reversibile, in acciaio inox AISI 304 sp. 12/10 - 15/10 - 20/10 (su richiesta AISI 316), con guarnizione poliuretana bicomponente. Cerniere in acciaio inossidabile AISI 316.

Composizione

Struttura, pannello di cablaggio, porta, confezione di viteria.

Grado di protezione

IP 66 in accordo con IEC EN 62208; EN 60529.

TYPE 4X in accordo con UL508A; UL50

Grado di resistenza all'urto

IK10 secondo IEC EN 62208

A richiesta versione AISI 316 per tutte le misure.

Structure

AISI 304 stainless steel th. 12/10 - 15/10 (AISI 316 on request). Without entry cable flanges.

Mounting panel

20/10 thick galvanized steel.

Door

Reversible, AISI 304 stainless steel th. 12/10 - 15/10 (AISI 316 on request), provided with a polyurethane two-component seal. AISI 316 stainless steel hinges.

Composition

Structure, mounting panel, door, set of fasteners.

Protection degree

IP 66 in accordance with IEC EN 62208; EN 60529.

TYPE 4X in accordance with UL508A; UL50

Mechanical resistance degree

IK10 as per IEC EN 62208

On request AISI 316 version for all sizes.

H 300

CODICE CODE	LARGHEZZA (mm) WIDTH (mm)	DIMENSIONI, MM DIMENSIONS, MM	
		PROFONDITÀ (mm) DEPTH (mm)	
RICEB03911	250	150	
RICEB03311	300	150	
RICEB03411	400	150	

H 400

CODICE CODE	LARGHEZZA (mm) WIDTH (mm)	DIMENSIONI, MM DIMENSIONS, MM	
		PROFONDITÀ (mm) DEPTH (mm)	
RICEB04311	300	150	
RICEB04321	300	200	
RICEB04421	400	200	
RICEB04621	600	200	

H 500

CODICE CODE	LARGHEZZA (mm) WIDTH (mm)	DIMENSIONI, MM DIMENSIONS, MM	
		PROFONDITÀ (mm) DEPTH (mm)	
RICEB05311	300	150	
RICEB05321	300	200	
RICEB05421	400	200	
RICEB05491	400	250	
RICEB05521	500	200	

■ Casse INOX

Stainless steel CE boxes

Casse serie CE Inox - Anta singola

Stainless steel CE Box - Single door



H 600

CODICE CODE	LARGHEZZA (mm) WIDTH (mm)	DIMENSIONI, MM
		DIMENSIONS, MM
		PROFONDITÀ (mm) DEPTH (mm)
RICEB06421		200
RICEB06491	400	250
RICEB06441		400
RICEB06691		250
RICEB06641	600	400

H 700

CODICE CODE	LARGHEZZA (mm) WIDTH (mm)	DIMENSIONI, MM
		DIMENSIONS, MM
		PROFONDITÀ (mm) DEPTH (mm)
RICEB07521		200
RICEB07591	500	250

H 800

CODICE CODE	LARGHEZZA (mm) WIDTH (mm)	DIMENSIONI, MM
		DIMENSIONS, MM
		PROFONDITÀ (mm) DEPTH (mm)
RICEB08691		250
RICEB08631		300
RICEB08641	600	400
RICEB08831		300
RICEB08841	800	400

H 1000

CODICE CODE	LARGHEZZA (mm) WIDTH (mm)	DIMENSIONI, MM
		DIMENSIONS, MM
		PROFONDITÀ (mm) DEPTH (mm)
RICEB10691		250
RICEB10631		300
RICEB10641	600	400
RICEB10831		300
RICEB10841	800	400

H 1200

CODICE CODE	LARGHEZZA (mm) WIDTH (mm)	DIMENSIONI, MM
		DIMENSIONS, MM
		PROFONDITÀ (mm) DEPTH (mm)
RICEB12631	600	
RICEB12831	800	300

H 1400

CODICE CODE	LARGHEZZA (mm) WIDTH (mm)	DIMENSIONI, MM
		DIMENSIONS, MM
		PROFONDITÀ (mm) DEPTH (mm)
RICEB14631	600	
RICEB14831	800	300

■ Casse INOX

Stainless steel CE boxes

Casse serie CE Inox - Doppia anta

Stainless steel CE Box - Double door



IP55

Struttura

Acciaio inox AISI 304 sp. 15/10 (su richiesta AISI 316). Senza flange ingresso cavi.

Pannello di cablaggio

Lamiera d'acciaio sp. 20/10 zincato.

Porta doppia anta

Reversibile, in acciaio inox AISI 304 sp.15/10 - 20/10 (su richiesta AISI 316), con guarnizione poliuretana bicomponente.

Cerniere in acciaio inossidabile AISI 316.

Composizione

Struttura, pannello di cablaggio, porta, confezione di viteria.

Grado di protezione

IP 55 in accordo con IEC EN 62208; EN 60529.

NEMA 12 in accordo con UL508A; UL50

Grado di resistenza all'urto

IK10 secondo IEC EN 62208

A richiesta versione AISI 316 per tutte le misure.

Structure

AISI 304 stainless steel th. 15/10 (AISI 316 on request). Without entry cable flanges.

Mounting panel

20/10 thick galvanized steel.

Door with two leaves

Reversible, AISI 304 stainless steel th. 15/10 (AISI 316 on request), provided with a polyurethane two-component seal. AISI 316 stainless steel hinges.

Composition

Structure, mounting panel, door, set of fasteners.

Protection degree

IP 55 in accordance with IEC EN 62208;EN 60529.

TYPE 12 in accordance with UL508A; UL50

Mechanical resistance degree

IK10 as per IEC EN 62208

On request AISI 316 version for all sizes.

H 600

CODICE CODE	LARGHEZZA (mm) WIDTH (mm)	DIMENSIONI, MM	PROFONDITÀ (mm) DEPTH (mm)
		DIMENSIONS, MM	
RICEB06831	800		300

H 800

CODICE CODE	LARGHEZZA (mm) WIDTH (mm)	DIMENSIONI, MM	PROFONDITÀ (mm) DEPTH (mm)
		DIMENSIONS, MM	
RICEB08121			200
RICEB08131	1000		300

H 1000

CODICE CODE	LARGHEZZA (mm) WIDTH (mm)	DIMENSIONI, MM	PROFONDITÀ (mm) DEPTH (mm)
		DIMENSIONS, MM	
RICEB10131	1000		300

H 1200

CODICE CODE	LARGHEZZA (mm) WIDTH (mm)	DIMENSIONI, MM	PROFONDITÀ (mm) DEPTH (mm)
		DIMENSIONS, MM	
RICEB12131	1000		300
RICEB121231	1200		

H 1400

CODICE CODE	LARGHEZZA (mm) WIDTH (mm)	DIMENSIONI, MM	PROFONDITÀ (mm) DEPTH (mm)
		DIMENSIONS, MM	
RICEB14131	1000		300

■ Casse INOX

Stainless steel CE boxes

Casse serie CE Inox porta trasparente

CE Box with glazed door AISI 304



IP66

Struttura

Acciaio inox AISI 304 sp. 12/10 - 15/10 (su richiesta AISI 316). Senza flange ingresso cavi.

Pannello di cablaggio

Lamiera d'acciaio sp. 20/10 zincato.

Porta

Reversibile, in acciaio inox AISI 304 sp.12/10 - 15/10 - 20/10 (su richiesta AISI 316), con guarnizione poliuretanic bicomponente. Cerniere in acciaio inossidabile AISI 316.

Composizione

Struttura, pannello di cablaggio, porta, confezione di viteria.

Grado di protezione

IP 66 in accordo con IEC EN 62208; EN 60529.

Grado di resistenza all'urto secondo IEC EN 62208: IK09

A richiesta versione AISI 316 per tutte le misure.

Structure

AISI 304 stainless steel th. 12/10 - 15/10 (AISI 316 on request). Without entry cable flanges.

Mounting panel

20/10 thick galvanized steel.

Door

Reversible, AISI 304 stainless steel th. 12/10 - 15/10 (AISI 316 on request), provided with a polyurethane two-component seal.

AISI 316 stainless steel hinges.

Composition

Structure, mounting panel, door, set of fasteners.

Protection degree

IP 66 in accordance with IEC EN 62208; EN 60529.

Mechanical resistance degree as per IEC EN 62208: IK09

On request AISI 316 version for all sizes.

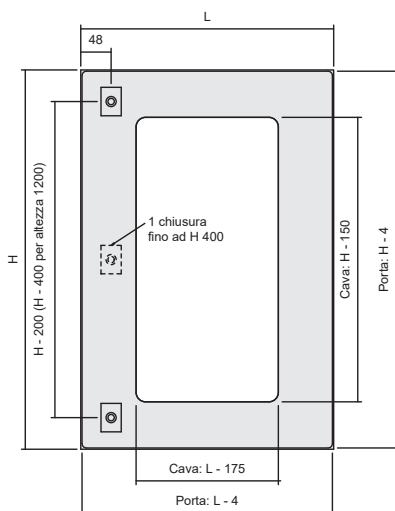

Vista fronte cassa con porta trasparente

H 400

CODICE CODE	LARGHEZZA (mm) WIDTH (mm)	DIMENSIONI, MM DIMENSIONS, MM PROFONDITÀ (mm) DEPTH (mm)	CHIUSURA LOCKING ELEMENT
RICEXB04321	300	200	1 Box

H 500

CODICE CODE	LARGHEZZA (mm) WIDTH (mm)	DIMENSIONI, MM DIMENSIONS, MM PROFONDITÀ (mm) DEPTH (mm)	CHIUSURA LOCKING ELEMENT
RICEXB05491	400	250	2 Box

H 600

CODICE C.CODE	LARGHEZZA (mm) WIDTH (mm)	DIMENSIONI, MM DIMENSIONS, MM PROFONDITÀ (mm) DEPTH (mm)	CHIUSURA LOCKING ELEMENT
RICEXB06491	400	250	2 Box
RICEXB06691	600		

H 700

CODICE C.CODE	LARGHEZZA (mm) WIDTH (mm)	DIMENSIONI, MM DIMENSIONS, MM PROFONDITÀ (mm) DEPTH (mm)	CHIUSURA LOCKING ELEMENT
RICEXB07591	500	250	2 Box

H 800

CODICE CODE	LARGHEZZA (mm) WIDTH (mm)	DIMENSIONI, MM DIMENSIONS, MM PROFONDITÀ (mm) DEPTH (mm)	CHIUSURA LOCKING ELEMENT
RICEXB08631	600	300	2 Box

■ Casse INOX Stainless steel CE boxes

Casse serie CE Inox porta trasparente
CE Box with glazed door AISI 304



H 1000

CODICE CODE	LARGHEZZA (mm) WIDTH (mm)	DIMENSIONI, MM DIMENSIONS, MM PROFONDITÀ (mm) DEPTH (mm)	CHIUSURA LOCKING ELEMENT
RICEXB10631	600	300	2 Box
RICEXB10831	800		

■ Casse INOX

Stainless steel CE boxes

Porta Interna Cassa Inox

Internal door for AISI 304 box



IP20

- Realizzate in lamiera d'acciaio inox AISI 304 (su richiesta AISI 316L) sp. 12/10
 - Regolabili in profondità, minimo 40 mm, massimo 65 mm.
 - Dotate di un punto di chiusura (due punti oltre altezza 700 compresa).
 - Montabile su tutte le profondità.
 - Confezione da 1 pezzo completa di viteria necessaria al montaggio.
 - Montabile su casse con profondità da 150 a 400 mm.
- Manufactured of 15/10 thick steel sheet, painted RAL 7035.
 - Adjustable in depth, min. 40 mm – max. 65 mm.
 - Provided with one closing point (two closing points for height 700 and above).
 - Installable to boxes with whatever depth.
 - Pack of 1 piece complete with fasteners.
 - Mountable to boxes with the depth of 150 to 400 mm.

H 400

CODICE CODE	DIMENSIONI, MM DIMENSIONS, MM LARGHEZZA (mm) WIDTH (mm)
RIIE431	300

H 500

CODICE CODE	DIMENSIONI, MM DIMENSIONS, MM LARGHEZZA (mm) WIDTH (mm)
RIIE541	400

H 600

CODICE CODE	DIMENSIONI, MM DIMENSIONS, MM LARGHEZZA (mm) WIDTH (mm)
RIIE641	400
RIIE661	600

H 700

CODICE CODE	DIMENSIONI, MM DIMENSIONS, MM LARGHEZZA (mm) WIDTH (mm)
RIIE751	500

H 800

CODICE CODE	DIMENSIONI, MM DIMENSIONS, MM LARGHEZZA (mm) WIDTH (mm)
RIIE861	600

H 1000

CODICE CODE	DIMENSIONI, MM DIMENSIONS, MM LARGHEZZA (mm) WIDTH (mm)
RIIE161	600
RIIE181	800

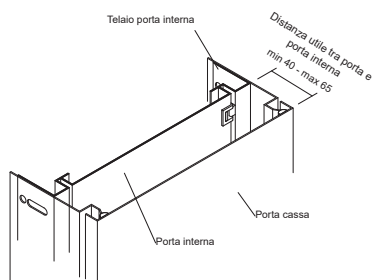
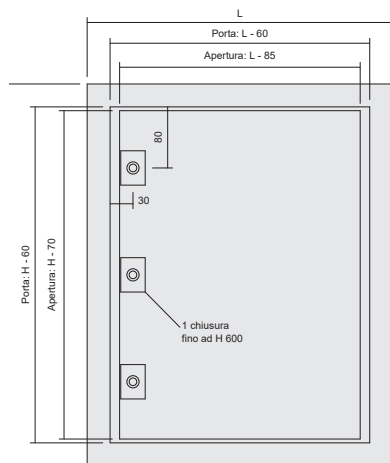

■ Casse INOX

Stainless steel CE boxes

Telaio modulare completo per casse CE Inox

Modular frame for CE and AISI 304 CE Box



Telaio modulare, grado di protezione IP 20. Struttura in lamiera d'acciaio INOX AISI 304. È fornito già assemblato nelle sue parti, ed è richiesto solo il montaggio nella cassa. Portina frontale, anch'essa in lamiera d'acciaio INOX AISI 304, con cava e fissata al telaio tramite cerniere. E' dotata di chiusure con viti antisfilamento. Guida di chiusure con viti antisfilamento. Guida DIN per ogni cava modulare.

Modular frame, protection degree IP20. Structure: AISI 304 stainless steel sheet. Assembly ready to be mounted to a box. The front door is AISI 304 stainless steel sheet, grooved and fixed to the frame by means of hinges. Provided with captive screws. Each modular cut-out is complete with a DIN guide. Available in various height and width configurations.

H 400

CODICE CODE	DIMENSIONI, MM DIMENSIONS, MM LARGHEZZA (mm) WIDTH (mm)
RITMC431	300

H 500

CODICE CODE	DIMENSIONI, MM DIMENSIONS, MM LARGHEZZA (mm) WIDTH (mm)
RITMC541	400

H 600

CODICE CODE	DIMENSIONI, MM DIMENSIONS, MM LARGHEZZA (mm) WIDTH (mm)
RITMC641	400

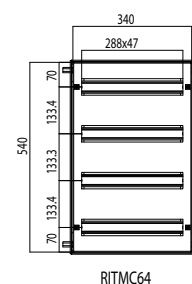
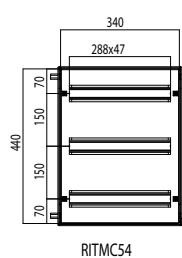
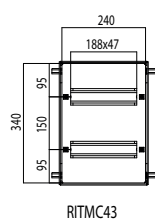

■ Casse INOX

Stainless steel CE boxes

Telaio modulare per casse CE Inox - Solo cornice

Modular frame for CE and AISI 304 CE Box - frame only

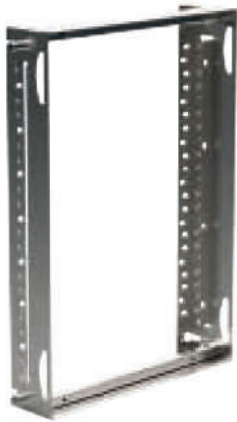

Telaio modulare, solo struttura, fornito in lamiera d'acciaio INOX AISI 304.

Modular frame only. Structure: AISI 304 stainless steel sheet.

H 600

CODICE CODE	DIMENSIONI, MM DIMENSIONS, MM LARGHEZZA (mm) WIDTH (mm)
RITMN661	600

H 700

CODICE CODE	DIMENSIONI, MM DIMENSIONS, MM LARGHEZZA (mm) WIDTH (mm)
RITMN751	500

H 800

CODICE CODE	DIMENSIONI, MM DIMENSIONS, MM LARGHEZZA (mm) WIDTH (mm)
RITMN861	600

H 1000

CODICE CODE	DIMENSIONI, MM DIMENSIONS, MM LARGHEZZA (mm) WIDTH (mm)
RITMN1061	600
RITMN1081	800

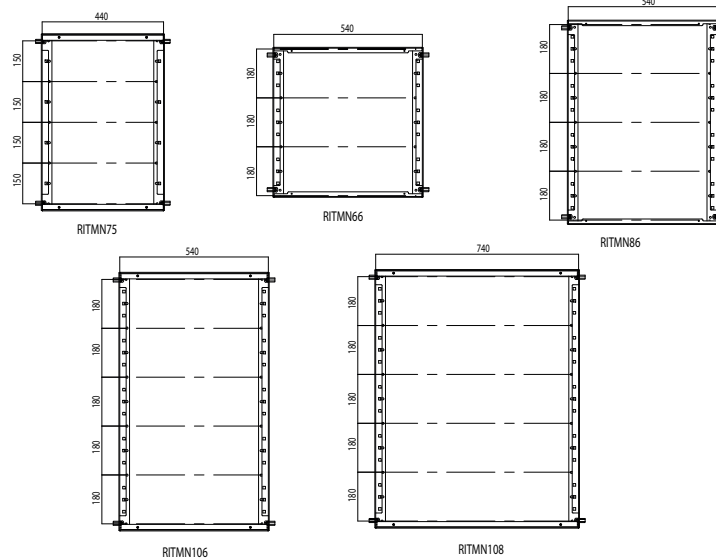

■ Casse INOX

Stainless steel CE boxes

Pannelli avvitati ciechi per casse CE Inox

Blank panel for CE and AISI 304 CE Box

Pannello cieco per telaio modulare, Grado di protezione IP20 INOX AISI 304.

Blank Panel for modular frame, Degree of protection IP20 INOX AISI 304.



H 150

CODICE CODE	DIMENSIONI, MM DIMENSIONS, MM LARGHEZZA (mm) WIDTH (mm)
RIPFC51501	500

H 180

CODICE CODE	DIMENSIONI, MM DIMENSIONS, MM LARGHEZZA (mm) WIDTH (mm)
RIPFC61801	600
RIPFC81801	800

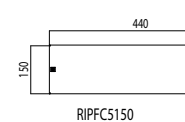
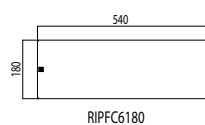
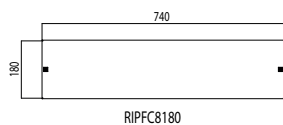

■ Casse INOX

Stainless steel CE boxes

Pannelli avvitati con guida DIN per casse CE Inox

Distribution panel DIN module for CE and AISI 304 CE Box

Pannello di Distribuzione con guida DIN integrata INOX AISI 304.

Blank Panel for modular frame , degree of protection IP20 INOX AISI 304.

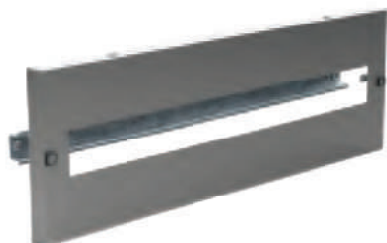

H 150

CODICE CODE	DIMENSIONI, MM DIMENSIONS, MM LARGHEZZA (mm) WIDTH (mm)
RIPFC51511	500

H 180

CODICE CODE	DIMENSIONI, MM DIMENSIONS, MM LARGHEZZA (mm) WIDTH (mm)
RIPFC61811	600
RIPFC81811	800

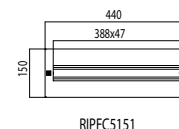
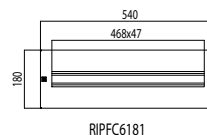
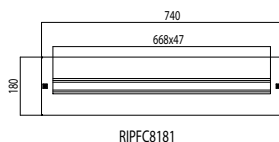

■ Casse INOX Stainless steel CE boxes

Tetto Protezione Casse INOX Protective canopy INOX

Tetto di protezione realizzato in lamiera d'acciaio INOX AISI 304 sp. 15/10. Confezione da 1 pezzo completa di viteria necessaria per il montaggio.

Protective canopy. Manufactured of 15/10 INOX AISI 304 thick sheet steel. Pack of 1 piece complete with fasteners necessary for mounting.



CODICE CODE	DIMENSIONI, MM DIMENSIONS, MM	
	LARGHEZZA (mm) WIDTH (mm)	PROFONDITÀ (mm) DEPTH (mm)
RITT0321	300	200
RITT0491	400	
RITT0591	500	250
RITT0691	600	
RITT0631	800	300
RITT0831	800	
RITT1031	1000	

Staffa Fissaggio Ce-Cde AISI 316 Fixing bracket CE-CDE AISI 316



- Realizzate in acciaio inox AISI 316, sp. 15/10.
- Particolarmente indicate per il fissaggio della cassa a parete.
- Confezione completa di viteria per il montaggio.
- Carico massimo ammissibile 4x60 Kg.

- Made of AISI 316 stainless steel, th. 15/10.
- Particularly suitable for wall-mounting of boxes.
- Complete with accessories and screws for assembly.
- Max. allowable load 4x60 Kg.

CODICE CODE	DIMENSIONI, MM DIMENSIONS, MM	
	CONFEZIONI/PZ PACK/PCS	
RIA502	4	

■ Casse INOX

Stainless steel CE boxes

Guide di rinforzo porta

Reinforcement rails for doors



- Realizzate in lamiera d'acciaio sp. 15/10 zincata sendzimir.
- Fori da 4,2 mm a passo 25 mm.
- Confezione completa di viteria per il montaggio.

- Made of 15/10 thick Sendzimir galvanized steel.
- 4.2 mm holes with 25 mm pitch.
- Complete with accessories and screws for assembly.

H 500

CODICE CODE	DIMENSIONI, MM DIMENSIONS, MM CONFEZIONI/PZ PACK/PCS
RZS50	2

H 600

CODICE CODE	DIMENSIONI, MM DIMENSIONS, MM CONFEZIONI/PZ PACK/PCS
RZS60	2

H 700

CODICE CODE	DIMENSIONI, MM DIMENSIONS, MM CONFEZIONI/PZ PACK/PCS
RZS70	2

H 800

CODICE CODE	DIMENSIONI, MM DIMENSIONS, MM CONFEZIONI/PZ PACK/PCS
RZS80	2

H 1000

CODICE CODE	DIMENSIONI, MM DIMENSIONS, MM CONFEZIONI/PZ PACK/PCS
RZS100	2

H 1200

CODICE CODE	DIMENSIONI, MM DIMENSIONS, MM CONFEZIONI/PZ PACK/PCS
RZS120	2

H 1400

CODICE CODE	DIMENSIONI, MM DIMENSIONS, MM CONFEZIONI/PZ PACK/PCS
RZS140	2

■ Casse INOX

Stainless steel CE boxes

Box casse in acciaio Inox AISI 316

AISI 316 Locking system



- Box di chiusura in zama cromata completa di inserto tipo aletta doppio pettine Ø 3mm.
- Box di chiusura in acciaio inox AISI 316 completa di inserto tipo aletta doppio pettine Ø 3mm.
- Box lock made of chromed zamak complete with a Ø 3mm double-bit lock insert.
- Box lock made of AISI 316 stainless steel complete with a Ø 3mm double-bit lock insert.

CODICE CODE	DIMENSIONI, MM DIMENSIONS, MM FINITURA FINISHING
RZCE206	Zama cromata / Chromed zamak
RICE313	Acciaio inox AISI 316 / Stainless steel AISI 316

Chiusura a box

Box lock



** Inserto da montare in sostituzione agli inserti standard (doppio pettine Ø 3 mm) .

** Insert to be mounted instead of standard inserts (double-bit Ø 3 mm).

CHIUSURA LOCKING	CODICE CODE	DESCRIZIONE DESCRIPTION	
	RPCE205	Chiusura completa di inserto tipo aletta doppio pettine Ø 3 mm Locking element complete with double-bit lock insert Ø 3 mm	
	CODICE CODE		
INSERTO INSERT	CHIAVE IN PLASTICA PLASTIC KEY	INSERTO INSERT	DESCRIZIONE DESCRIPTION
	RPCE240	RZCE261	Aletta doppio pettine Ø 3 mm Double-bit lock insert Ø 3 mm
	RPCE246	RZCE224	Triangolo 8 mm Triangle 8 mm
	RPCE245	RZCE223	Triangolo 7 mm Triangle 7 mm
	RZCE237*	RZCE226	Tipo FIAT FIAT type
	RPCE243	RZCE221	Quadro 7 mm Square 7 mm
		RZCE227**	Chiusura completa (con chiavi uguali) Complete lock (with equal keys)
		RZCE228**	Chiusura completa (con chiavi uguali) Complete lock (with equal keys)

* chiave in metallo
* metal key







■ Casse INOX

Stainless steel CE boxes

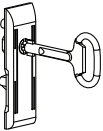
Chiusura a cariglione

Ratchet lock



CHIUSURA LOCKING	CODICE CODE	DESCRIZIONE DESCRIPTION	
	RZCE200	Chiusura completa di inserto tipo aletta doppio pettine Ø 3 mm Locking element complete with double-bit lock insert Ø 3 mm	
CODICE CODE			
INSERTO INSERT	CHIAVE IN PLASTICA PLASTIC KEY	INSERTO INSERT	DESCRIZIONE DESCRIPTION
	RZCE230	RZCE219	Aletta doppio pettine Ø 3 mm Double-bit lock insert Ø 3 mm
	RZCE236	RZCE214	Triangolo 8 mm Triangle 8 mm
	RZCE235	RZCE213	Triangolo 7 mm Triangle 7 mm
	RZCE234	RZCE212	Quadro 8 mm Square 8 mm
	RZCE233	RZCE211	Quadro 7 mm Square 7 mm

** Inserto da montare in sostituzione agli inserti standard (doppio pettine Ø 3 mm) .

** Insert to be mounted instead of standard inserts (double-bit Ø 3 mm).

■ Casse INOX

Stainless steel CE boxes

Casse CDE Inox - Cassa Derivazione AISI 304

CDE box AISI 304 - Junction Box AISI 304



IP66

Struttura

acciaio inox AISI 304 (su richiesta AISI 316)
sp. 12/10.

Coperchio avvitato

acciaio inox AISI 304 (su richiesta AISI 316)
sp. 12/10 con guarnizione poliuretana
bicomponente.

Grado di protezione

IP 66 in accordo con IEC EN 62208; EN
60529. NEMA 4X in accordo con UL508A;
UL50.

Grado di resistenza all'urto secondo IEC EN 62208: IK10.

A richiesta versione AISI 316 per tutte le
misure.

Structure

AISI 304 stainless steel (AISI 316 on
request) th. 12/10.

Screwed cover

AISI 304 stainless steel (AISI 316 on
request) th. 12/10 with a polyurethane
twocomponent seal.

Protection degree

IP 66 in accordance with IEC EN 62208;
EN 60529. TYPE 4X in accordance with
UL508A; UL50.

Mechanical resistance degree as per IEC EN 62208: IK10.

On request version AISI 316 for all sizes.

H 150

CODICE CODE	LARGHEZZA (mm) WIDTH (mm)	DIMENSIONI, MM DIMENSIONS, MM
		PROFONDITÀ (mm) DEPTH (mm)
RICDE11801	150	80
RICDE11201		120

H 200

CODICE CODE	LARGHEZZA (mm) WIDTH (mm)	DIMENSIONI, MM DIMENSIONS, MM
		PROFONDITÀ (mm) DEPTH (mm)
RICDE22801	200	80
RICDE221201		120

H 300

CODICE CODE	LARGHEZZA (mm) WIDTH (mm)	DIMENSIONI, MM DIMENSIONS, MM
		PROFONDITÀ (mm) DEPTH (mm)
RICDE311201	150	120
RICDE32801		80
RICDE321201	200	
RICDE331201	300	120

H 400

CODICE CODE	LARGHEZZA (mm) WIDTH (mm)	DIMENSIONI, MM DIMENSIONS, MM
		PROFONDITÀ (mm) DEPTH (mm)
RICDE42801	200	80
RICDE421201		
RICDE431201	300	120
RICDE441201	400	

H 500

CODICE CODE	LARGHEZZA (mm) WIDTH (mm)	DIMENSIONI, MM DIMENSIONS, MM
		PROFONDITÀ (mm) DEPTH (mm)
RICDE521201	200	
RICDE531201	300	120

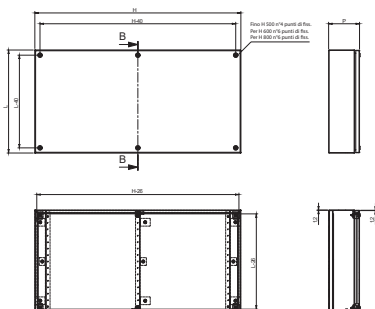

■ Casse INOX

Stainless steel CE boxes

Casse CDE Inox - Cassa Derivazione AISI 304

CDE box AISI 304 - Junction Box AISI 304



H 600

CODICE CODE	LARGHEZZA (mm) WIDTH (mm)	DIMENSIONI, MM DIMENSIONS, MM	
		PROFONDITÀ (mm) DEPTH (mm)	
RICDE62801	200	80	
RICDE621201	300	120	
RICDE631201	400	120	

H 800

CODICE CODE	LARGHEZZA (mm) WIDTH (mm)	DIMENSIONI, MM DIMENSIONS, MM	
		PROFONDITÀ (mm) DEPTH (mm)	
RICDE82801	200	80	
RICDE821201	300	120	
RICDE841201	400	120	

Profili DIN

DIN Profiles

- Fissaggio sui traversini delle casse.
- Confezione da 10 pezzi.
- Completa di accessori per il montaggio.
- Mountable onto box rails.
- Pack of 10 pieces.
- Complete with mounting accessories.



CODICE CODE	DIMENSIONI, MM DIMENSIONS, MM	
	LARGHEZZA (mm) WIDTH (mm)	
RZCDO15	150	
RZCDO18	180	
RZCDO20	200	
RZCDO30	300	
RZCDO40	400	
RZCDO50	500	
RZCDO60	600	
RZCDO80	800	

■ Casse INOX

Stainless steel CE boxes

Piastra interna per casse di derivazione

Internal plate for CDE junction boxes

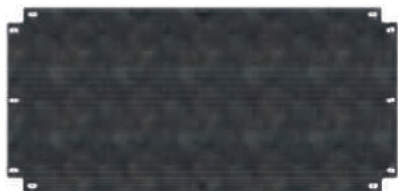

- Realizzata in lamiera d'acciaio zincata sendzimir sp. 20/10.
- Fissata all'involucro tramite i traversini già presenti all'interno della cassa.
- Completa di accessori per il montaggio.

- Manufactured of 20/10 Sendzimir galvanized steel.
- Fixed to the enclosure by means of mounting bars provided inside the box.
- Complete with mounting accessories.

H 150

CODICE CODE	DIMENSIONI, MM DIMENSIONS, MM LARGHEZZA (mm) WIDTH (mm)
RZCDP11	150

H 180

CODICE CODE	DIMENSIONI, MM DIMENSIONS, MM LARGHEZZA (mm) WIDTH (mm)
RZCDP91	150
RZCDP29	180

H 200

CODICE CODE	DIMENSIONI, MM DIMENSIONS, MM LARGHEZZA (mm) WIDTH (mm)
RZCDP22	200

H 300

CODICE CODE	DIMENSIONI, MM DIMENSIONS, MM LARGHEZZA (mm) WIDTH (mm)
RZCDP31	150
RZCDP32	200
RZCDP33	300

H 400

CODICE CODE	DIMENSIONI, MM DIMENSIONS, MM LARGHEZZA (mm) WIDTH (mm)
RZCDP42	200
RZCDP43	300
RZCDP44	400

H 500

CODICE CODE	DIMENSIONI, MM DIMENSIONS, MM LARGHEZZA (mm) WIDTH (mm)
RZCDP52	200
RZCDP53	300

H 600

CODICE CODE	DIMENSIONI, MM DIMENSIONS, MM LARGHEZZA (mm) WIDTH (mm)
RZCDP62	200
RZCDP63	300
RZCDP64	400

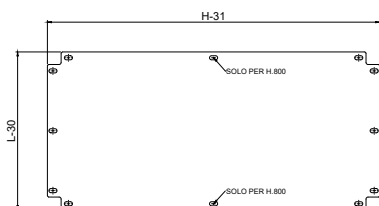

■ Casse INOX

Stainless steel CE boxes

Piastra interna per casse di derivazione

Internal plate for CDE junction boxes

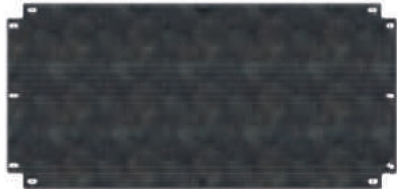

H 800

CODICE CODE	DIMENSIONI, MM DIMENSIONS, MM LARGHEZZA (mm) WIDTH (mm)
RZCDP82	200
RZCDP84	400

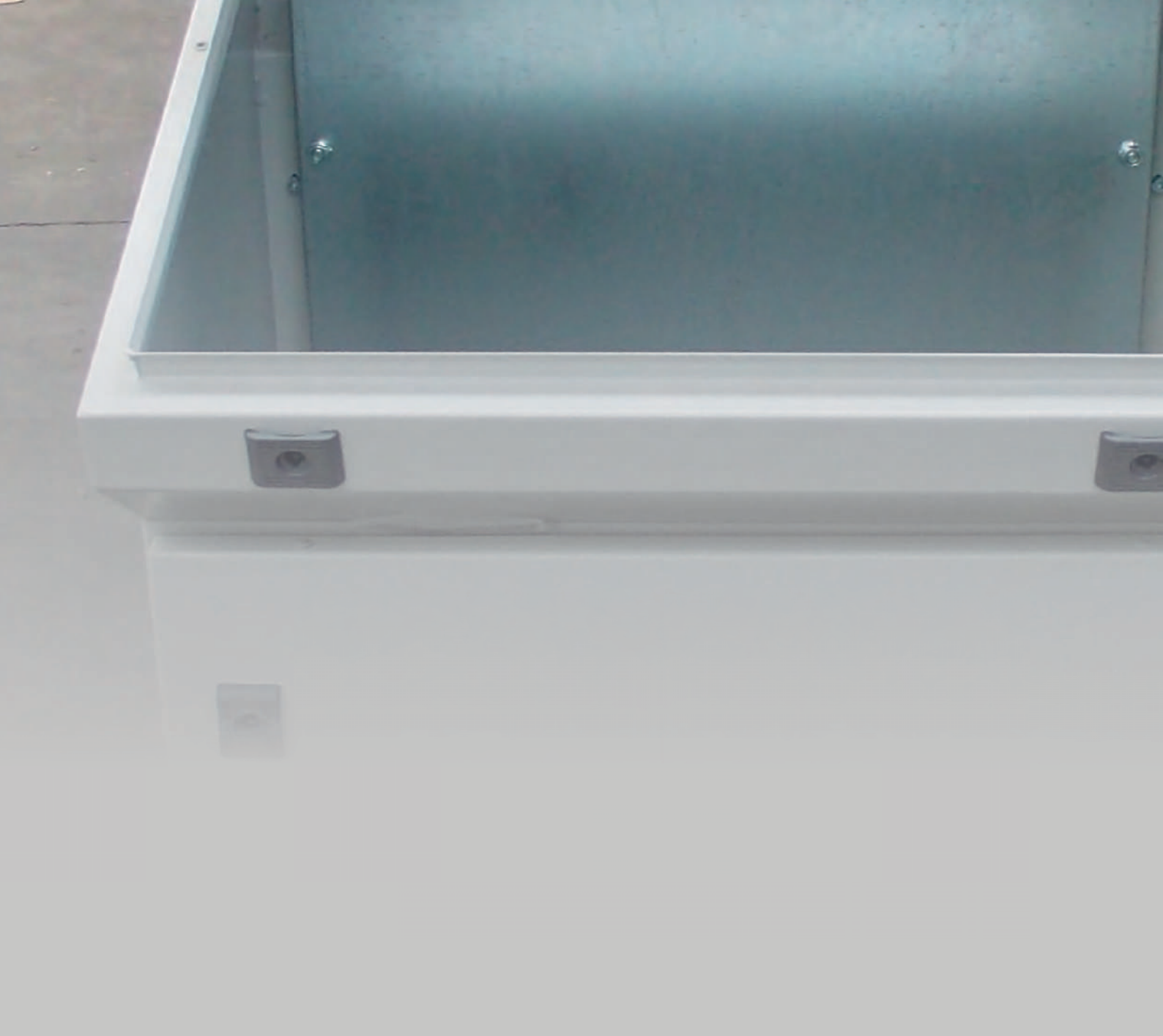

Pulpiti Consoles

■ Pulpiti Consoles

Caratteristiche Generali General characteristics



Pulpiti COMPATTO, COMPONENTIBILE e VIDEO, per installazione INDOOR.

Struttura in lamiera d'acciaio spessore 15/10 con saldatura continua sulle giunzioni.
Fondo cassa dotato di serie di flangia ingresso cavi divisa in due unità .
Porta di chiusura mensola di spessore 20/10, con predisposizione interna per il fissaggio di due profili forati a passo 25mm.

Pulpito COMPATTO

Dotato di serie di pannello di cablaggio in lamiera zincata SENDZIMIR® di spessore 20/10 sul fondo dell'involucro.
Previsto con porta frontale e pannello posteriore asportabili, di spessore 15/10.

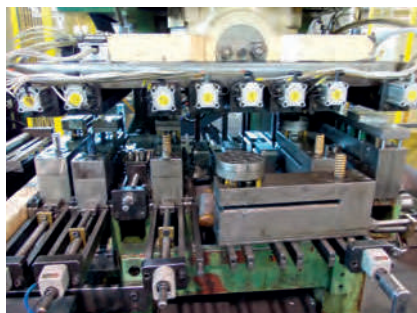

Pulpito COMPONENTIBILE e VIDEO

Possibile la differente combinazione dei vari elementi a formare insiemi differenti a seconda delle applicazioni richieste.
Cassa dotata di pannello di cablaggio in lamiera zincata SENDZIMIR® di spessore 20/10, regolabile in profondità a passo 25mm.
Parte posteriore dotata di pannello asportabile nella versione COMPONENTIBILE e di porta incernierata nella versione VIDEO.

La verniciatura viene eseguita di serie con polveri epossipoliestere, colore standard RAL 7035.

Il ciclo di verniciatura standard applicato è classificabile, secondo la norma UNI ISO 12944-2018, come C3 con durabilità M.

Il grado di protezione del pulpito COMPATTO è IP55. In esecuzione COMPONENTIBILE oppure VIDEO è IP55 se è realizzata una delle combinazioni indicate in questo capitolo.



COMPACT, MODULAR and VIDEO pulpits, for INDOOR installation.

15/10 thick sheet steel structure with continuous welding on the joints. Case back equipped as standard with cable entry flange divided into two units. Shelf closing door 20/10 thick, with internal predisposition for fixing two perforated profiles with 25mm pitch.

COMPACT pulpit

Equipped as standard with 20/10 thick SENDZIMIR® galvanized sheet cabling panel on the bottom of the casing. Provided with removable front door and rear panel, 15/10 thick.

MODULAR and VIDEO pulpit

It is possible the different combination of the various elements to form different sets according to the required applications. Casing equipped with 20/10 thick SENDZIMIR® galvanized sheet cabling panel, adjustable in depth at 25mm pitch. Rear part with removable panel in the MODULAR version and hinged door in the VIDEO version.

The painting is carried out as standard with epoxy-polyester powders, standard color RAL 7035. The applied standard painting cycle can be classified, according to UNI ISO 12944-2018, as C3 with durability M.

The degree of protection of the COMPACT pulpit is IP55. In MODULAR or VIDEO execution it is IP55 if one of the combinations indicated on this chapter.

Pulpiti

Consoles

Caratteristiche Tecniche

Technical characteristics

Conformità e omologazioni

Conformity and approvals



Grado di protezione

- **IP 55** in accordo con IEC EN 62208; EN 60529
- **TYPE 1, 12** in accordo con UL508A; UL50
- Grado di protezione garantito dalla guarnizione in schiuma poliuretana bi-componente
- Grado di resistenza all'urto **IK10** in accordo con IEC EN 62208; EN 50102

Protection degree

- **IP 55** according to IEC EN 62208; EN 60529
- **TYPE 1, 12** according to UL508A; UL50
- The protection degree is guaranteed by a seal of two-component polyurethane foam
- Impact resistance degree **IK10** according to IEC EN 62208; EN 50102

Pulpito COMPATTO PN

PN COMPACT Console



Porta mensola incernierata con anta di fermo per evitare chiusure accidentali.
Hinged desk lid with shutter stop to prevent accidental closing

Chiusure a box
Box locking elements

Pannello di cablaggio fisso, asportabile e non regolabile in profondità. Possibilità inserimento dall'alto.
Fixed mounting panel, removable and non-adjustable in depth. May be inserted from the top

Apertura porta 130°
130° door opening

Fondo ingresso cavi regolabile in lamiera zincata.
Bottom cable gland plate of galvanized sheet steel

Pulpito COMPONENTIBILE e VIDEO

MODULAR and VIDEO Consoles

Retro ispezionabile con viti nella versione componibile e con chiusura a doppio pettine per la versione video.
Accessible rear, with screws in Modular version and double-bit lock insert in Video version

Pannello di cablaggio asportabile e regolabile in profondità.
Accessible rear, with screws in Modular version and double-bit lock insert in Video version

Fondo ingresso cavi regolabile in lamiera zincata.
Bottom cable gland plate of galvanized sheet steel



Fermo meccanico porta per evitare chiusure accidentali.
Door stop preventing accidental closing

Chiusure a box
Box locking elements

Apertura porta 130°
130° door opening

■ Pulpiti industriali Consoles

Pulpito compatto PN PN compact console



IP55

Struttura

realizzata in lamiera d'acciaio sp. 15/10 verniciata RAL 7035 bucciato.

Porta della mensola

realizzata in lamiera d'acciaio sp. 20/10 verniciata RAL 7035 bucciato completo di aste di sostegno per arresto porta.

Porta della cassa e pannello posteriore

asportabili, realizzati in lamiera d'acciaio sp. 15/10 verniciati RAL 7035 bucciato.

Fondo ingresso cavi

regolabile in due metà. Realizzato in lamiera d'acciaio zincata sp. 15/10

Pannello di cablaggio

asportabile realizzato in lamiera d'acciaio zincata sp. 20/10 fissato sul fondo dell'involucro.

Composizione

struttura, porte, pannello posteriore, fondo ingresso cavi e pannello di cablaggio.

Grado di protezione

IP 55 EN 60529 soddisfa TYPE 1, 12.

Structure

Made of 15/10 thick steel sheet, painted textured RAL 7035.

Desk lid

Made of 20/10 thick steel sheet, painted textured RAL 7035, complete with support bars for lid stop.

Base door and rear panel

Removable, made of 15/10 thick steel sheet, painted textured RAL 7035.

Bottom cable gland plate

Composed of two parts, adjustable. Made of 15/10 thick galvanized steel sheet.

Mounting panel

Removable, made of 20/10 thick galvanized steel sheet, fixed at the bottom of the enclosure.

Composition

structure, doors, rear panel, bottom cable gland plate and mounting panel.

Protection degree

IP 55 EN 60529 compliant to NEMA 1, 12.

H 973

DIMENSIONI, MM DIMENSIONS, MM

CODICE CODE	LARGHEZZA (mm) WIDTH (mm)	PROFONDITÀ (mm) DEPTH (mm)	B B	C C	D D	E E	F F	G G
R5PN600	600	380	547	586	596	475	540	547
R5PN800	800		747	786	796	675	740	747
R5PN1000	1000		947	986	996	875	940	947
R5PN1200	1200		1147	1186	1196	475x2	1140	1147
R5PN1600	1600		1547	1586	1596	675x2	1540	1547
R5PN2000	2000		1947	1986	1996	875x2	1940	1947

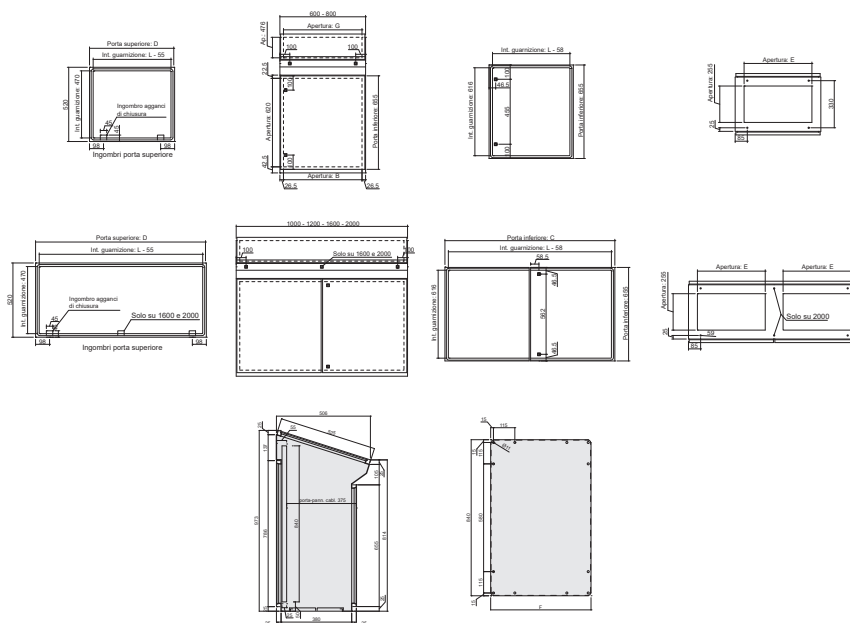

■ Pulpiti industriali Consoles

Cassa Pulpito Componibile Modular console base



IP55

Struttura

realizzata in lamiera d'acciaio sp. 15/10 verniciata RAL 7035 bucciato.

Porta anteriore

realizzata in lamiera d'acciaio sp. 15/10 verniciata RAL 7035 bucciato.

Pannello posteriore asportabile

realizzato in lamiera d'acciaio sp. 15/10 verniciata RAL 7035 bucciato

Fondo ingresso cavi

regolabile in due metà, realizzato in lamiera d'acciaio zincata sp. 15/10.

Pannello di cablaggio

realizzato in lamiera d'acciaio zincata sp. 20/10 regolabile in profondità a passo 25mm.

Composizione

struttura, porte, pannello posteriore, fondo ingresso cavi e pannello di cablaggio.

Grado di protezione

IP 55 EN 60529 soddisfa TYPE 1, 12 se assemblati come da configurazione.

Structure

Made of 15/10 thick steel sheet, painted textured RAL 7035.

Front door

Made of 15/10 thick steel sheet, painted textured RAL 7035.

Rear removable panel

Made of 15/10 thick steel sheet, painted textured RAL 7035.

Bottom cable gland plate

Composed of two parts, adjustable. Made of 15/10 thick galvanized steel sheet.

Mounting panel

Removable, made of 20/10 thick galvanized steel sheet, adjustable in depth with 25 mm pitch.

Composition

Structure, doors, rear panel, bottom cable gland plate and mounting panel.

Protection degree

IP 55 EN 60529 compliant to NEMA 1, 12 if assembled as the configuration.

H 690

CODICE CODE	LARGHEZZA (mm) WIDTH (mm)	PROFONDITÀ (mm) DEPTH (mm)	DIMENSIONI, MM DIMENSIONS, MM				
			A A	B B	C C	D D	E E
R5CPC600	600	380	586	500	475	547	531
R5CPC800	800		786	700	675	747	731
R5CPC1000	1000		986	900	875	947	931
R5CPC1200	1200		1186	1100	1075	1147	1131
R5CPC1600	1600		1586	1500	1475	1547	1531

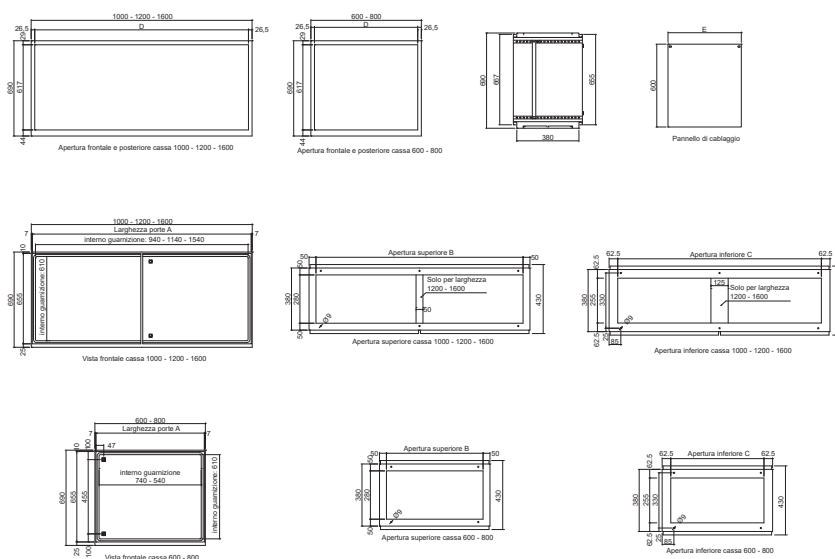

■ Pulpiti industriali Consoles

Alzata Pulpito Componibile Modular console top



IP55

Struttura

Realizzata in lamiera d'acciaio sp. 15/10 verniciata RAL 7035 bucciato.

Pannello posteriore

Asportabile realizzato in lamiera d'acciaio sp. 15/10 verniciata RAL 7035 bucciato.

Porta anteriore

Realizzata in lamiera d'acciaio sp. 20/10 completa di aste di sostegno per l'arresto.

Pannello di cablaggio

Realizzato in lamiera d'acciaio zincata sp. 20/10 regolabile in profondità a passo 25mm.

Composizione

Struttura, porta anteriore, pannello posteriore, pannello di cablaggio.

Grado di protezione

IP 55 EN 60529 soddisfa TYPE 1, 12 se assemblati come da configurazione.

Structure

Made of 15/10 thick steel sheet, painted textured RAL 7035.

Rear panel

Removable, made of 15/10 thick steel sheet, painted textured RAL 7035.

Front door

Made of 20/10 thick steel sheet, complete with support bars for door stop.

Mounting panel

Made of 20/10 thick galvanized steel sheet, adjustable in depth with 25 mm pitch.

Composition

Structure, front door, rear panel, mounting panel.

Protection degree

IP 55 EN 60529 compliant to TYPE 1, 12 if assembled as the configuration.

CODICE CODE	LARGHEZZA (mm) WIDTH (mm)	PROFONDITÀ (mm) DEPTH (mm)	DIMENSIONI, MM DIMENSIONS, MM			
			H H	I I	K K	M M
R5APC600	600	380	596	547	500	531
R5APC800	800		796	747	700	731
R5APC1000	1000		996	947	900	931
R5APC1200	1200		1196	1147	1100	1131
R5APC1600	1600		1596	1547	1500	1531

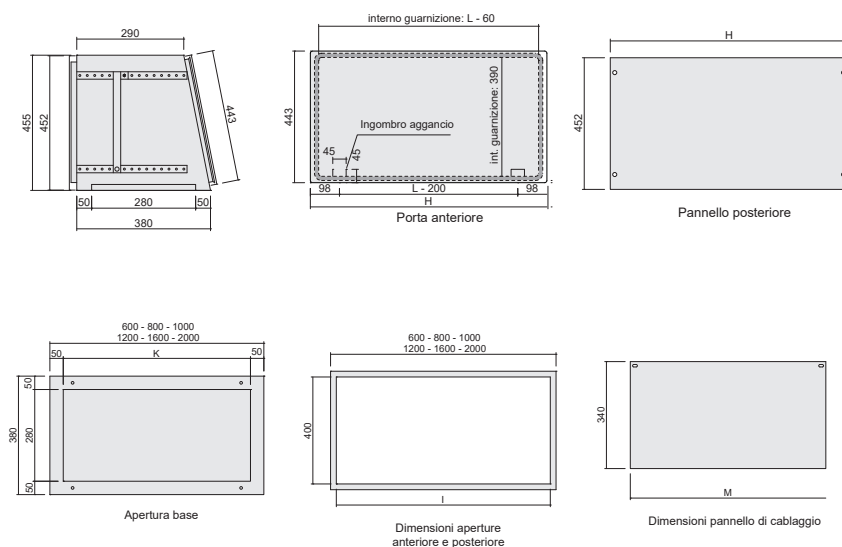

■ Pulpiti industriali Consoles

Mensola pulpito componibile Modular console desk



Struttura

Realizzata in lamiera d'acciaio sp. 15/10 verniciata RAL 7035 bucciato.

Porta superiore

Realizzata in lamiera d'acciaio sp. 20/10 verniciata RAL 7035 bucciato. Completa di aste di sostegno per l'arresto della porta.

Composizione

Struttura, porta superiore.

Grado di protezione

IP 55 EN 60529 soddisfa TYPE 1, 12 se assemblati come da configurazione.

Structure

Made of 15/10 thick steel sheet, painted textured RAL 7035.

Upper lid

Made of 20/10 thick steel sheet, painted textured RAL 7035. Complete with support bars for lid stop.

Composition

Structure, upper lid.

Protection degree

IP 55 EN 60529 compliant to TYPE 1, 12 if assembled as the configuration.

IP55

CODICE CODE	LARGHEZZA (mm) WIDTH (mm)	DIMENSIONI, MM DIMENSIONS, MM		
		PROFONDITÀ (mm) DEPTH (mm)	F F	G G
R5MPC600	600	443	547	500
R5MPC800	800		747	700
R5MPC1000	1000		947	900
R5MPC1200	1200		1147	1100
R5MPC1600	1600		1547	1500

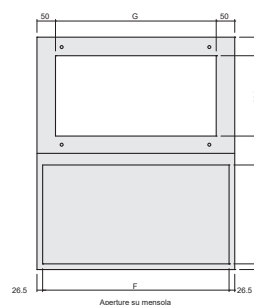
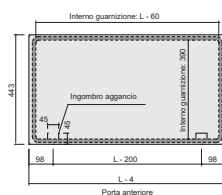
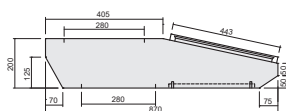

■ Pulpiti industriali

Consoles

Coperchio per pulpito componibile

Cover for Modular consoles



- Realizzato in lamiera d'acciaio sp. 15/10 verniciato RAL 7035 bucciato.
- Utilizzato come coperchio per le casse e le mensole della serie VIDEO e COMPONIBILE.
- Confezione da 1 pezzo completa di viteria necessaria al montaggio e di guarnizione di tenuta.
- Made of 15/10 thick steel sheet, painted textured RAL 7035.
- Usable as a cover for bases and desks of VIDEO and MODULAR lines.
- Pack of 1 piece complete with mounting accessories, screws and seal.

CODICE CODE	LARGHEZZA (mm) WIDTH (mm)	DIMENSIONI, MM DIMENSIONS, MM	
		PROFONDITÀ (mm) DEPTH (mm)	LARGHEZZA ELEMENTO (mm) ELEMENT WIDTH (mm)
R5CC600	600	426	596
R5CC800	800		796
R5CC1000	1000		996
R5CC1200	1200		1196
R5CC1600	1600		1596

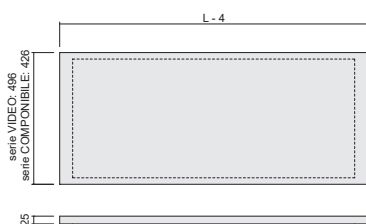

■ Pulpiti industriali Consoles

Cassa Pulpito Video Video console base



IP55

Struttura

realizzata in lamiera d'acciaio sp. 15/10 verniciata RAL 7035 bucciato.

Porta anteriore e porta posteriore

realizzate in lamiera d'acciaio sp. 15/10 verniciate RAL 7035 bucciato.

Fondo ingresso cavi

regolabile in due metà, realizzato in lamiera d'acciaio zincata sp. 15/10.

Pannello di cablaggio

realizzato in lamiera d'acciaio zincata sp. 20/10 regolabile in profondità a passo 25mm.

Composizione

struttura, porte, fondo ingresso cavi e pannello di cablaggio.

Grado di protezione

IP 55 EN 60529 soddisfa TYPE 1, 12 se assemblati come da configurazione.

Structure

Made of 15/10 thick steel sheet, painted textured RAL 7035.

Front and rear door

Made of 15/10 thick steel sheet, painted textured RAL 7035.

Bottom cable gland plate

Composed of two parts, adjustable. Made of 15/10 thick galvanized steel sheet.

Mounting panel

Made of 20/10 thick galvanized steel sheet, adjustable in depth with 25 mm pitch.

Composition

Structure, doors, bottom cable gland plate and mounting panel.

Protection degree

IP 55 EN 60529 compliant to TYPE 1, 12 if assembled as the configuration.

CODICE CODE	LARGHEZZA (mm) WIDTH (mm)	PROFONDITÀ (mm) DEPTH (mm)	DIMENSIONI, MM DIMENSIONS, MM				
			A A	B B	C C	D D	E E
R5CPV600	600	500	586	500	475	547	531
R5CPV800	800		786	700	675	747	731
R5CPV1000	1000		986	900	875	947	931
R5CPV1200	1200		1186	1100	1075	1147	1131
R5CPV1600	1600		1586	1500	1475	1547	1531

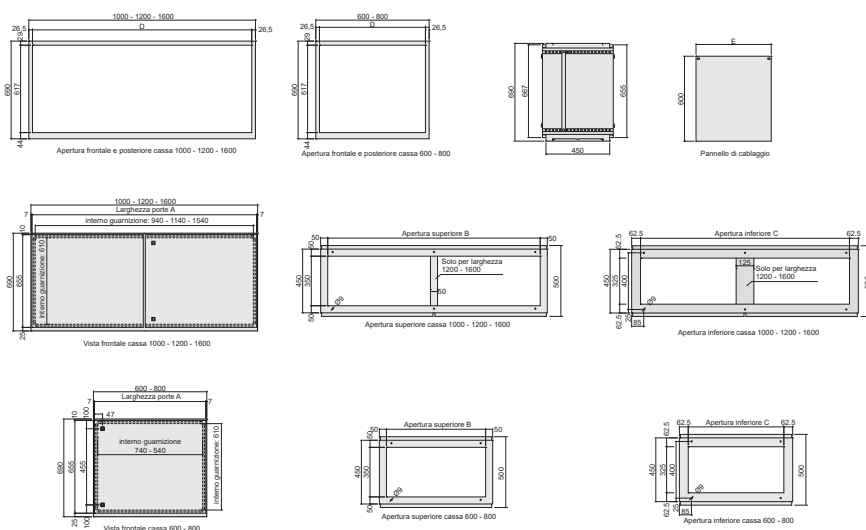

■ Pulpiti industriali Consoles

Alzata Pulpito Video Video console top



IP55

Struttura

Realizzata in lamiera d'acciaio sp. 15/10 verniciata RAL 7035 bucciato.

Porta posteriore

Realizzata in lamiera d'acciaio sp. 20/10 verniciata RAL 7035 bucciato.

Porta anteriore

Realizzata in lamiera d'acciaio sp. 20/10 completa di aste di sostegno per l'arresto.

Pannello di cablaggio

Realizzato in lamiera d'acciaio zincata sp.20/10 regolabile in profondità a passo 25mm.

Composizione

Struttura, porte, pannello di cablaggio.

Grado di protezione

IP 55 EN 60529 soddisfa TYPE 1, 12 se assemblati come da configurazione.

Structure

Made of 15/10 thick steel sheet, painted textured RAL 7035.

Rear door

Made of 15/10 thick steel sheet, painted textured RAL 7035.

Front door

Made of 20/10 thick steel sheet, complete with support bars for door stop.

Mounting panel

Made of 20/10 thick galvanized steel sheet, adjustable in depth with 25 mm pitch.

Composition

Structure, doors, mounting panel.

Protection degree

IP 55 EN 60529 compliant to TYPE 1, 12 if assembled as the configuration.

CODICE CODE	LARGHEZZA (mm) WIDTH (mm)	PROFONDITÀ (mm) DEPTH (mm)	DIMENSIONI, MM DIMENSIONS, MM			
			H H	I I	K K	M M
R5APV600	600	450	596	547	500	531
R5APV800	800		796	747	700	731
R5APV1000	1000		996	947	900	931
R5APV1200	1200		1196	1147	1100	1131
R5APV1600	1600		1596	1547	1500	1531

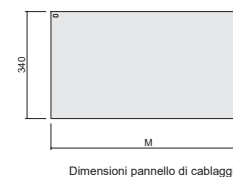
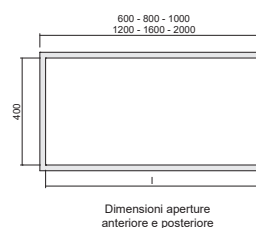
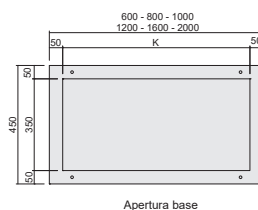
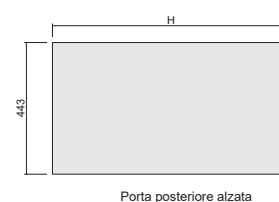
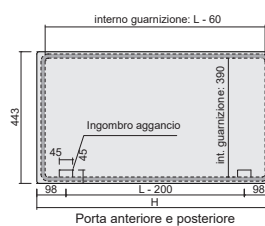
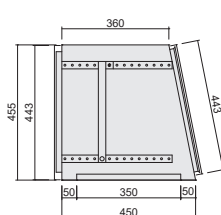

■ Pulpiti industriali Consoles

Mensola Pulpito Video Video console desk



IP55

Struttura

realizzata in lamiera d'acciaio sp. 15/10 verniciata RAL 7035 bucciato.

Porta superiore

realizzata in lamiera d'acciaio sp. 20/10 verniciata RAL 7035 bucciato. Completa di aste di sostegno per l'arresto della porta.

Composizione

struttura, porta superiore.

Grado di protezione

IP 55 EN 60529 soddisfa TYPE 1, 12 se assemblati come da configurazione.

Structure

Made of 15/10 thick steel sheet, painted textured RAL 7035.

Upper lid

Made of 20/10 thick steel sheet, painted textured RAL 7035. Complete with support bars for lid stop.

Composition

Structure, upper lid.

Protection degree

IP 55 EN 60529 compliant to TYPE 1, 12 if assembled as the configuration.

H 200

CODICE CODE	LARGHEZZA (mm) WIDTH (mm)	DIMENSIONI, MM DIMENSIONS, MM		
		PROFONDITÀ (mm) DEPTH (mm)	F F	G G
R5MPV600	600	443	547	500
R5MPV800	800		747	700
R5MPV1000	1000		947	900
R5MPV1200	1200		1147	1100
R5MPV1600	1600		1547	1500

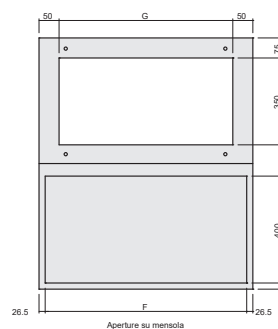
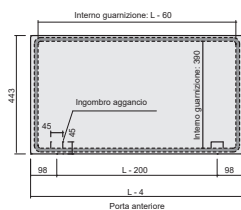
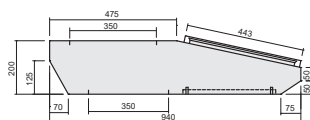

■ Pulpiti industriali

Consoles

Coperchio Pulpito Video

Cover for video console



- Realizzato in lamiera d'acciaio sp. 15/10 verniciato RAL 7035 bucciato.
- Utilizzato come coperchio per le casse e le mensole della serie VIDEO e COMPONENTIBILE.
- Confezione da 1 pezzo completa di viteria necessaria al montaggio e di guarnizione di tenuta.
- Made of 15/10 thick steel sheet, painted textured RAL 7035.
- Usable as a cover for bases and desks of VIDEO and MODULAR lines.
- Pack of 1 piece complete with mounting accessories, screws and seal.

CODICE CODE	LARGHEZZA (mm) WIDTH (mm)	DIMENSIONI, MM DIMENSIONS, MM	
		PROFONDITÀ (mm) DEPTH (mm)	LARGHEZZA ELEMENTO (mm) ELEMENT WIDTH (mm)
R5CV600	600	496	596
R5CV800	800		796
R5CV1000	1000		996
R5CV1200	1200		1196
R5CV1600	1600		1596

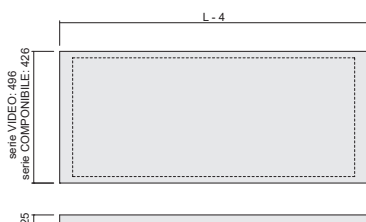

■ Pulpiti industriali Consoles

Pannello di cablaggio supplementare per cassa serie componibile e video Additional mounting plate for modular and video cabinets

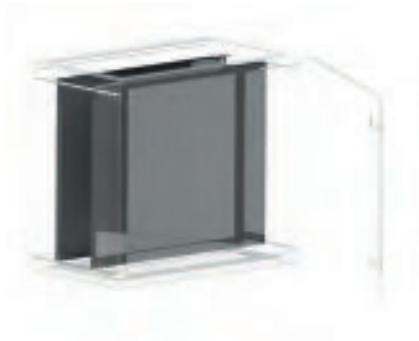

- Realizzato in lamiera d'acciaio zincata sendzimir sp. 20/10.
- Confezione da 1 pezzo completa di accessori e viteria per il montaggio.

- Made of 20/10 thick Sendzimir galvanized steel.
- Pack of 1 piece complete with mounting accessories and screws.

H 600

CODICE CODE	DIMENSIONI, MM DIMENSIONS, MM	
	LARGHEZZA (mm) WIDTH (mm)	A A
RZPC600	531	531
RZPC800	800	731
RZPC1000	1000	931
RZPC1200	1200	1131
RZPC1600	1600	1531

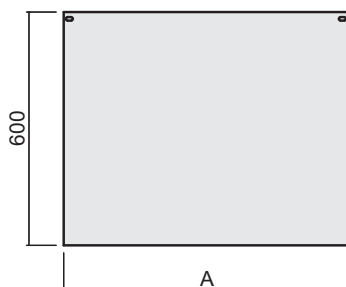

■ Pulpiti industriali Consoles

Pannello porta apparecchiature per serie componibile e video Equipment support panel for modular and video desks



- Fissato orizzontalmente all'interno delle mensole, permette l'ancoraggio di diverse apparecchiature.
- Realizzato in lamiera d'acciaio sp. 20/10 zincata.
- Confezione da 1 pezzo completa di viteria necessaria al montaggio e di angolari per il fissaggio.
- Fixed horizontally inside the shelves, it allows the anchoring of different equipment.
- Made of 20/10 thick galvanized steel.
- Pack of 1 piece complete with accessories, screws and mounting angles.

CODICE CODE	LARGHEZZA (mm) WIDTH (mm)	DIMENSIONI, MM DIMENSIONS, MM	
		LARGHEZZA ELEMENTO (mm) ELEMENT WIDTH (mm)	PROFONDITÀ ELEMENTO (mm) ELEMENT DEPTH (mm)
RZPPM600	600	500	350
RZPPM800	800	700	
RZPPM1000	1000	900	
RZPPM1200	1200	1100	
RZPPM1600	1600	1500	

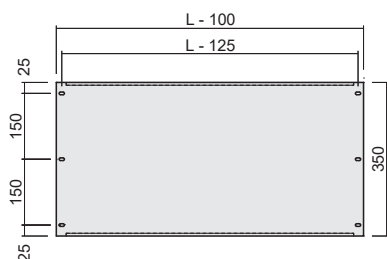

■ Pulpiti industriali

Consoles

Tasca portaschemi in plastica

Plastic pocket for wiring diagrams



- Realizzate in plastica. Colore RAL 7035.
- La versione in plastica è universale. (Fissaggio mediante biadesivo)

- Plastic version. Color: RAL 7035.
- The plastic version is universal (attachable by double-sided tape).

H 220

CODICE CODE	PROFONDITÀ (mm) DEPTH (mm)	DIMENSIONI, MM DIMENSIONS, MM
		LARGHEZZA ELEMENTO (mm) ELEMENT WIDTH (mm)
RPA32	30	230

Golfari di sollevamento per pulpiti

Lifting eyebolts for consoles



Confezione da 2 pezzi completa di accessori e viteria per il montaggio.

Pack of 2 pieces complete with mounting accessories and fasteners.

CODICE CODE
RZA34

Traversini porta apparecchiature serie PN

Equipment support rails for PN desks



- Realizzati in lamiera d'acciaio sp. 15/10zincata.
- Montati tramite prigionieri all'interno delle porte dei pulpiti, sono generalmente utilizzati per il fissaggio di guide DIN standard.
- Confezione da 2 pezzi completa di viteria necessaria al montaggio.

- Made of 15/10 thick steel sheet.
- Mountable inside the console lids by means of studs, they are generally used for standard DIN guides installation.
- Pack of 2 pieces complete with accessories and screws for assembly.

CODICE CODE	DIMENSIONI, MM DIMENSIONS, MM
	LARGHEZZA ELEMENTO (mm) ELEMENT WIDTH (mm)
RZS01	PN

■ Pulpiti industriali Consoles

Traversini porta apparecchiature serie componibile e video Equipment support rails for modular and video desks



- Realizzati in lamiera d'acciaio sp. 15/10zincata.
- Montati tramite prigionieri all'interno delle porte dei pulpiti, sono generalmente utilizzati per il fissaggio di guide DIN standard.
- Confezione da 2 pezzi completa di viteria necessaria al montaggio.
- Made of 15/10 thick steel sheet.
- Mountable inside the console lids by means of studs, they are generally used for standard DIN guides installation.
- Pack of 2 pieces complete with accessories and screws for assembly.

CODICE CODE	DIMENSIONI, MM DIMENSIONS, MM LARGHEZZA ELEMENTO (mm) ELEMENT WIDTH (mm)
RZS02	Componibile - Video

■ Pulpiti industriali Consoles

Zoccoli per Pulpito serie COMPATTO PN e COMPONENTE Plinth for COMPACT PN and MODULAR consoles series

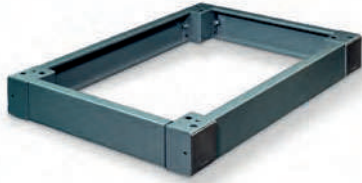

Gli zoccoli sono realizzati abbinando:
angolare + flangia frontale + flangia laterale.

- Angolare realizzato in lamiera d'acciaio sp. 25/10 verniciato RAL 7011 bucciato.
- Flange frontali e laterali in lamiera d'acciaio sp. 15/10 verniciato RAL 7011 bucciato.
- Completo di viteria per il montaggio.

Per la versione H200 sostituire il numero finale del codice con 2.

Per il cod. R1ZPRO381 non fornibile altezza 200mm. E' possibile assemblare 2 pezzi da H100mm.

The plinths are made by matching: angular + front flange + side flange.

- Angular sheet steel sp. 25/10 painted RAL 7011 textured.
- Front and side flanges in steel sheet sp. 15/10 painted RAL 7011 textured.
- Complete with mounting bolts and screws.

For the H200 version replace the number ending the code with 2.

For code R1ZPRO381, height 200 mm cannot be supplied. It is possible to assemble 2 pieces of H100mm.

H 100



Codice Code	ANGOLARE ANGULAR	ZOCOLO H.100 PLINTH H.100 FLANGIA FRONTALE FRONT FLANGE	FLANGIA LATERALE SIDE FLANGE
R5PN600		R1ZPRO601	
R5PN800		R1ZPRO801	
R5PN1000		R1ZPRO1001	
R5PN1200		R1ZPRO1201	
R5PN1600		R1ZPRO1601	
R5PN2000		R1ZPRO2001	
R5CPC600	R1ZCOR1	R1ZPRO601	R1ZPRO381
R5CPC800		R1ZPRO801	
R5CPC1000		R1ZPRO1001	
R5CPC1200		R1ZPRO1201	
R5CPC1600		R1ZPRO1601	

■ Pulpiti industriali Consoles

Zoccoli per Pulpito VIDEO Plinth for VIDEO series



Gli zoccoli sono realizzati abbinando:
angolare + flangia frontale + flangia laterale.

- Angolare realizzato in lamiera d'acciaio sp. 25/10 verniciato RAL 7011 bucciato.
- Flange frontali e laterali in lamiera d'acciaio sp. 15/10 verniciato RAL 7011 bucciato.
- Completo di viteria per il montaggio.

Per la versione H200 sostituire il numero finale del codice con 2.

Per il cod. R1ZPRO381 non fornibile altezza 200mm. E' possibile assemblare 2 pezzi da H100mm.

The plinths are made by matching: angular + front flange + side flange.

- Angular sheet steel sp. 25/10 painted RAL 7011 textured.
- Front and side flanges in steel sheet sp. 15/10 painted RAL 7011 textured.
- Complete with mounting bolts and screws.

For the H200 version replace the number ending the code with 2.

For code R1ZPRO381, height 200 mm cannot be supplied. It is possible to assemble 2 pieces of H100mm.

H 100



Codice Code	ANGOLARE ANGULAR	ZOCOLO H.100 PLINTH H.100 FLANGIA FRONTALE FRONT FLANGE	FLANGIA LATERALE SIDE FLANGE
R5CPV600		R1ZPRO601	
R5CPV800		R1ZPRO801	
R5CPV1000	R1ZCOR1	R1ZPRO1001	R1ZPRO501
R5CPV1200		R1ZPRO1201	
R5CPV1600		R1ZPRO1601	

Pulpiti industriali Consoles

Molle a Gas Gas springs



- In alternativa alle aste fornite a corredo del pulpito è possibile montare molle a gas.
- Il carico delle molle varia in funzione della larghezza della porta da sollevare.
- Confezione da 2 pezzi completa di viteria per il montaggio.

N.B.

La tabella sottostante aiuta a determinare le molle a gas in funzione della massa totale (espressa in kg) degli strumenti da montare. La massa è intesa come uniformemente distribuita sulla superficie utile della portella superiore.

- As an alternative to support bars supplied along with the console, it is possible to mount gas springs.
- The spring loads varies according to the width of a lid to be raised.
- Pack of 2 pieces complete with accessories and screws for assembly.

N.B.

The table below helps to select springs in accordance with the total weight (expressed in kg) of the equipment to be mounted. The weight is understood as a load uniformly distributed onto the whole usable surface of the upper lid.

CODICE CODE	LARGHEZZA PULPITO CONSOLE WIDTH					
	600	800	1000	1200	1600	2000
	CAPACITÀ DI CARICO, KG LOAD CAPACITY, KG					
RZMPG20	10	7	-	-	-	-
RZMPG25	15	13	11	-	-	-
RZMPG30	-	-	17	15	11	-
RZMPG35	-	-	-	-	17	13
RZMPG40	-	-	-	-	-	18

Chiusura a box per pulpiti Box lock for consoles



Chiusura completa di inserto tipo aletta doppio pettine Ø 3mm per porta della mensola ed alzata COMPONENTIBILE - VIDEO e porta superiore PN.

Locking element complete with a Ø3mm double-bit lock insert for desk and top lid of MODULAR/VIDEO console and upper lid of PN console.

CODICE
CODE

RPCE209

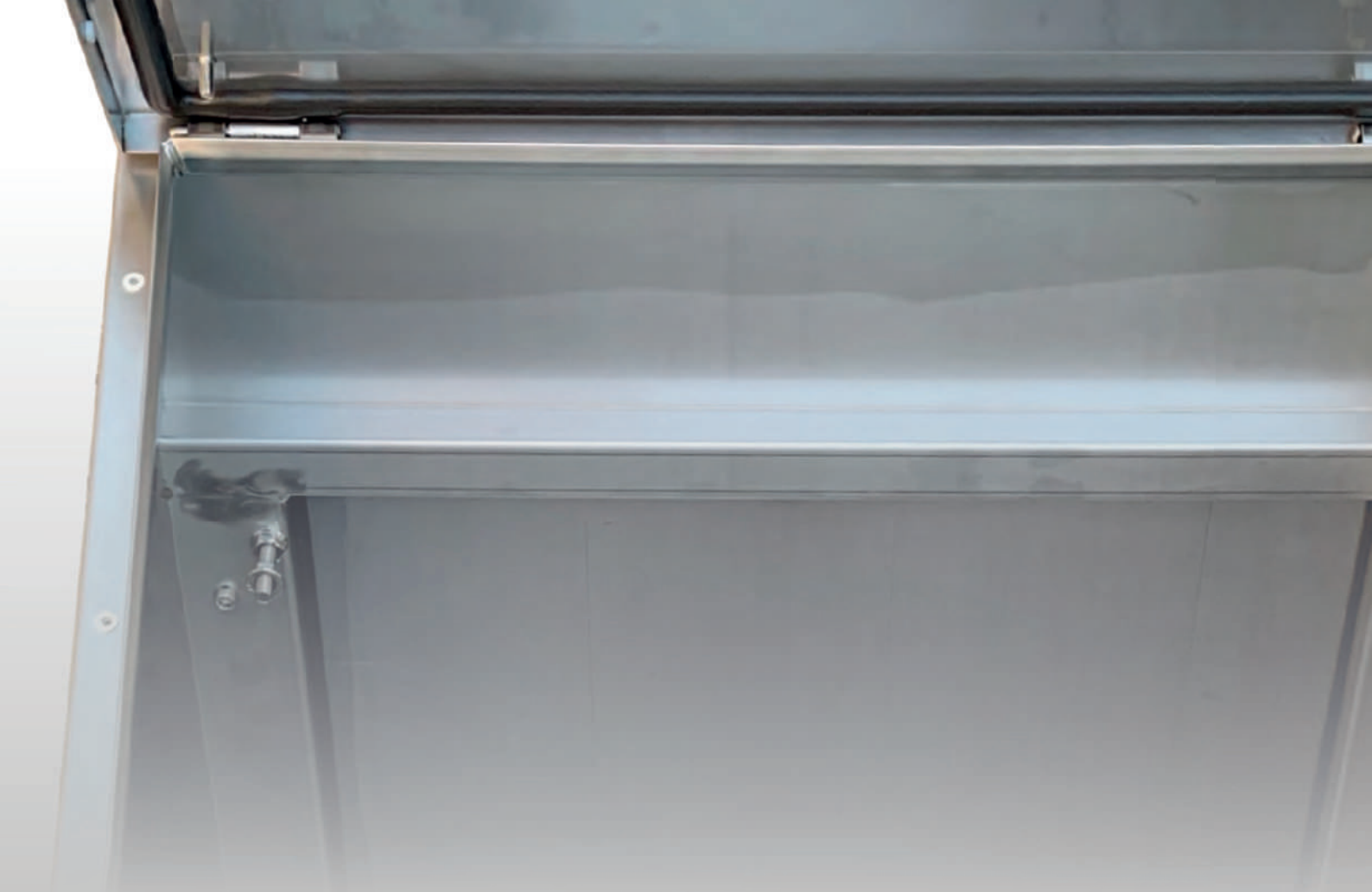

Pulpiti in Acciaio Inox
Stainless steel consoles

■ Pulpiti in Acciaio Inox Stainless steel consoles

Caratteristiche generali General characteristics



Pulpiti COMPATTO

Struttura in lamiera d'acciaio inox spessore 15/10 con saldatura continua sulle giunzioni.

Fondo dotato di serie di flangia ingresso cavi divisa in due unità .

Porta di chiusura mensola di spessore 20/10, con predisposizione interna per il fissaggio di due profili forati a passo 25mm

Dotato di serie di pannello di cablaggio in lamiera zincata SENDZIMIR® di spessore 20/10 sul fondo dell'involucro.

Previsto con porta frontale e pannello posteriore asportabili, di spessore 15/10. Il grado di protezione è IP 55

COMPACT console

Stainless steel sheet structure, thickness 5/10 with continuous welding on joints.

Bottom equipped with standard flange cable entry flange divided into two units. Shelf closing door of thickness 20/10 thick, with internal predisposition for the mounting of two 25mm pitch perforated profiles.

Equipped as standard with wiring panel in SENDZIMIR® galvanised sheet 20/10 thick on the bottom of the enclosure.

20/10 thick on the bottom of the enclosure. Supplied with removable front door and panel, 15/10 thick.

The degree of protection is IP 55



Conformità e omologazioni Conformity and approvals



Grado di protezione

- **IP 55** in accordo con IEC EN 62208; EN 60529
- Grado di protezione garantito dalla guarnizione in schiuma poliuretana bi-componente
- Grado di resistenza all'urto **IK10** in accordo con IEC EN 62208; EN 50102

Protection degree

- **IP 55** according to IEC EN 62208; EN 60529
- The protection degree is guaranteed by a seal of two-component polyurethane foam
- Impact resistance degree **IK10** according to IEC EN 62208; EN 50102

Pulpito COMPATTO PN PN COMPACT Console

Pannello di cablaggio fisso, asportabile e non regolabile in profondità. Possibilità inserimento dall'alto.
Fixed mounting panel, removable and non-adjustable in depth. May be inserted from the top

Fondo ingresso cavi regolabile in lamiera inox.
Bottom cable gland plate of stainless steel sheet.



Porta mensola incernierata con anta di fermo per evitare chiusure accidentali.
Hinged desk lid with shutter stop to prevent accidental closing

Chiusure a box
Box locking elements

Apertura porta 130°
130° door opening

■ Pulpito Inox Inox console

Pulpito compatto Compact console



IP55

Struttura

Realizzata in lamiera d'acciaio inox AISI 304 sp. 15/10.

Porta della mensola

Realizzata in lamiera d'acciaio inox AISI 304 sp. 20/10 completo di aste di sostegno per arresto porta.

Porta della cassa e pannello posteriore

Asportabili, realizzati in lamiera d'acciaio inox AISI 304 sp. 15/10.

Fondo ingresso cavi

Regolabile in due metà. Realizzato in lamiera d'acciaio inox AISI 304 sp. 15/10

Pannello di cablaggio

Asportabile realizzato in lamiera d'acciaio zincata sp. 20/10 fissato sul fondo dell'involucro.

Composizione

Struttura, porte, pannello posteriore, fondo ingresso cavi e pannello di cablaggio.

Grado di protezione

IP 55 EN 60529

A richiesta versione AISI 316 per tutte le misure.

Structure

Made of 15/10 AISI 304 stainless steel thick sheet.

Desk lid

Made of 20/10 AISI 304 stainless steel sheet, complete with support bars for lid stop.

Base door and rear panel

Removable, made of 15/10 AISI 304 stainless steel thick sheet.

Bottom cable gland plate

Composed of two parts, adjustable. Made of 15/10 AISI 304 stainless steel sheet.

Mounting panel

Removable, made of 20/10 thick galvanized steel sheet, fixed at the bottom of the enclosure.

Composition

structure, doors, rear panel, bottom cable gland plate and mounting panel.

Protection degree

IP 55 EN 60529

On request AISI 316 version for all size.

H 973

DIMENSIONI, MM
DIMENSIONS, MM

CODICE CODE	LARGHEZZA (mm) WIDTH (mm)	PROFONDITÀ (mm) DEPTH (mm)	B B	C C	D D	E E	F F	G G
RIPN6001	600	380	547	586	596	475	540	547
RIPN8001	800		747	786	796	675	740	747
RIPN10001	1000		947	986	996	875	940	947
RIPN12001	1200		1147	1186	1196	475x2	1140	1147

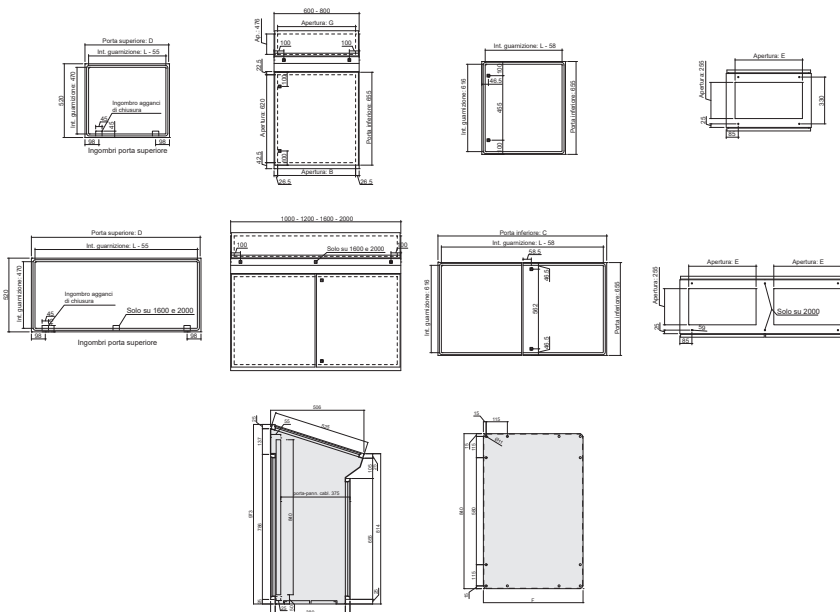

■ Pulpito Inox Inox console

Traversini porta apparecchiature serie PN Equipment support rails for PN desks



- Realizzati in lamiera d'acciaio sp. 15/10zincata.
- Montati tramite prigionieri all'interno delle porte dei pulpiti, sono generalmente utilizzati per il fissaggio di guide DIN standard.
- Confezione da 2 pezzi completa di viteria necessaria al montaggio.
- Made of 15/10 thick steel sheet.
- Mountable inside the console lids by means of studs, they are generally used for standard DIN guides installation.
- Pack of 2 pieces complete with accessories and screws for assembly.

CODICE CODE	DIMENSIONI, MM DIMENSIONS, MM LARGHEZZA ELEMENTO (mm) ELEMENT WIDTH (mm)
RZS01	PN

■ Pulpito Inox

Inox console

Zoccolo AISI 304

Plinth Stainless Steel AISI 304



Gli zoccoli sono realizzati abbinando: angolare + flangia frontale + flangia laterale.

- Angolare realizzato in lamiera d'acciaio inox AISI 304 sp. 20/10.
- Flange frontali e laterali in lamiera d'acciaio inox AISI 304 sp. 15/10.
- Completo di viteria per il montaggio.

A richiesta versione AISI 316 per tutte le misure.

The plinths are made by matching: angular + front flange + side flange.

- Angular AISI 304 stainless sheet steel th. 20/10.
- Front and side flanges in AISI 304 stainless steel sheet th.15/10.
- Complete with mounting bolts and screws.

On request AISI 316 version for all size.

H 100



Codice Code	ANGOLARE ANGULAR	ZOCCOLO H.100 PLINTH H.100 FLANGIA FRONTALE FRONT FLANGE	FLANGIA LATERALE SIDE FLANGE
RIPN6001		RIZPRO6011	
RIPN8001	RIZCOR11	RIZPRO8011	
RIPN10001		RIZPRO10011	R1ZPRO3811
RIPN12001		RIZPRO12011	



Sistema di sospensione a braccio portante
Load-bearing arm suspension system

■ Sistema di sospensione a braccio portante serie LIGHT

LIGHT support arm system

Caratteristiche Specifications



Il sistema di sospensione LIGHT può essere composto abbinando i vari giunti in alluminio con il tubolare 60x40 mm nella parte orizzontale del braccio ed eventualmente aggiungendo il tubolare circolare diametro 48 mm per la parte verticale. Disponibile anche la versione con partenza da terra.

Tale sistema è particolarmente indicato laddove sono previsti carichi leggeri.

Gli elementi fondamentali nella scelta della composizione del braccio sono la lunghezza e il peso del contenitore.

Le portate, indicate nel grafico sottostante, variano a seconda della composizione del sistema.

I giunti sono costruiti in lega di alluminio verniciata RAL 7035.

Le tenute a soffietto sono in materiale plastico colore RAL 7035.

Il tubolare di collegamento è in lamiera di acciaio verniciata RAL 7035 di dimensioni 60x40 mm, spessore 2 mm, con apertura per i passacavi di 54x34 mm.

Il tubo circolare, in lamiera di acciaio verniciata RAL 7035, è di diametro 48 mm, con apertura utile per i passacavi di 42 mm.

Il grado di protezione del sistema è IP54 secondo EN 60529.

Giunti, tubi e contenitori possono essere richiesti in colori speciali.

In base alle diverse esigenze, è possibile collegare i nuovi contenitori di comando serie ALUFRAME oppure le tradizionali casse DKC serie CE, CLE e CDE.

LIGHT support system can be composed combining various joints with 60x40 mm flat pipe for the horizontal part of the arm and, if necessary, adding a 48 mm circular pipe for the vertical part.

This system is particularly suitable where light weight loads are expected.

The fundamental parameters of the system composition choice are the arm length and the enclosure weight. The load capacity shown on the diagram below, vary depending on the arm composition.

Joints are manufactured of aluminium alloy painted RAL 7035. Corrugated gaskets are made of a plastic material of RAL 7035 color. The connection pipe is made of sheet steel painted RAL 7035 with the dimensions of 60x40 mm, 2 mm thick, with 54x34 mm bore for cables passage.

The circular pipe of sheet steel painted RAL 7035 has the diameter of 48 mm with 42 mm bore for cables passage.

The system protection degree is IP54 as per EN 60529.

Joints, pipes and enclosures of special colors can be supplied upon request. Based on different requirements it is possible to connect new ALUFRAME control enclosures or conventional DKC boxes of CE, CLE and CDE series.



IP54

CARATTERISTICHE TECNICHE

- **MATERIALE GIUNTI:** Lega di alluminio verniciata RAL 7035.
- **Materiale tubi:** Acciaio verniciato RAL 7035.
- **Colore soffietti:** RAL 7035.
- **Grado di protezione:** IP 54

TECHNICAL SPECIFICATIONS

- **Material of joints:** Aluminium alloy painted RAL 7035.
- **Material of pipes:** Steel painted RAL 7035.
- **Corrugated gaskets color:** RAL 7035.
- **Protection degree:** IP 54

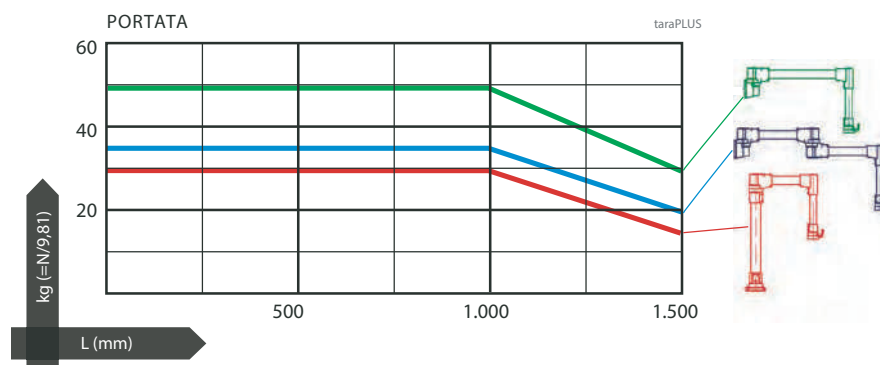

■ Sistema di sospensione a braccio portante serie LIGHT

LIGHT support arm system

Configurazioni con torretta rotante

Configuration with rotating turret

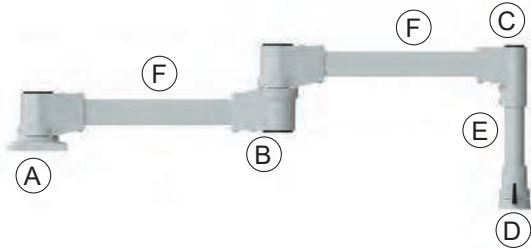

CONFIGURAZIONE 1
CONFIGURATION 1

RIF.	DESCRIZIONE DESCRIPTION	CODICE CODE	QUANTITÀ QUANTITY
A	Torretta rotante Rotating turret	R5SLSTR	1
B	Snodo intermedio Intermediate hinge	R5SLSIN	1
C	Adattatore angl. Angle coupling	R5SLSAF	1
D	Snodo dritto Straight joint	R5SLDF	1
E	Tubo circolare Circular pipe	R5SLTCX*	1
F	Tubo rettangolare Flat pipe	R5SLT6X*	2

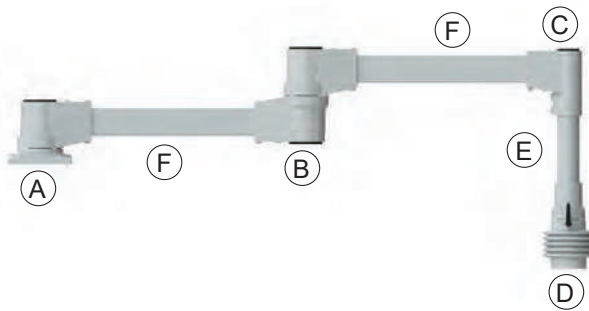

CONFIGURAZIONE 2
CONFIGURATION 2

RIF.	DESCRIZIONE DESCRIPTION	CODICE CODE	QUANTITÀ QUANTITY
A	Torretta rotante Rotating turret	R5SLSTR	1
B	Snodo intermedio Intermediate hinge	R5SLSIN	1
C	Adattatore angl. Angle coupling	R5SLSAF	1
D	Snodo inclinabile Tilting joint	R5SLSDI	1
E	Tubo circolare Circular pipe	R5SLTCX*	1
F	Tubo rettangolare Flat pipe	R5SLT6X*	2

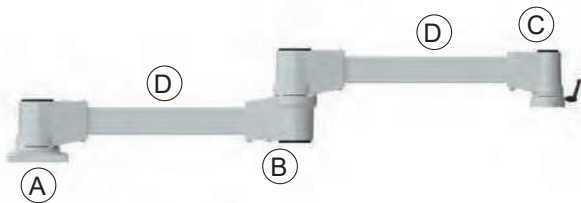

CONFIGURAZIONE 3
CONFIGURATION 3

RIF.	DESCRIZIONE DESCRIPTION	CODICE CODE	QUANTITÀ QUANTITY
A	Torretta rotante Rotating turret	R5SLSTR	1
B	Snodo intermedio Intermediate hinge	R5SLSIN	1
C	Snodo 90° 90° joint	R5SLSRF	1
D	Tubo rettangolare Flat pipe	R5SLT6X*	2

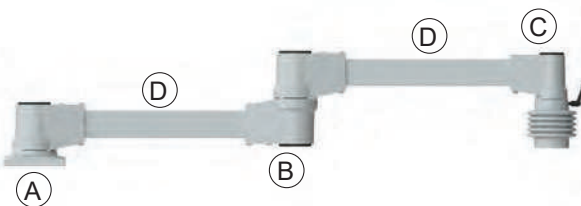

CONFIGURAZIONE 4
CONFIGURATION 4

RIF.	DESCRIZIONE DESCRIPTION	CODICE CODE	QUANTITÀ QUANTITY
A	Torretta rotante Rotating turret	R5SLSTR	1
B	Snodo intermedio Intermediate hinge	R5SLSIN	1
C	Snodo 90° inclinab. Tilting 90° joint	R5SLSRI	1
D	Tubo rettangolare Flat pipe	R5SLT6X*	2

Sostituire X con il numero relativo alla lunghezza del tubo necessario: 5 per il tubo da 500 mm, 1 per il tubo da 1000 mm.
X is to be substituted by a number relative to the required pipe length: 5 for 500 mm pipe, 1 for 1000 mm pipe.

■ Sistema di sospensione a braccio portante serie LIGHT

LIGHT support arm system

Configurazioni con torretta rotante

Configuration with rotating turret

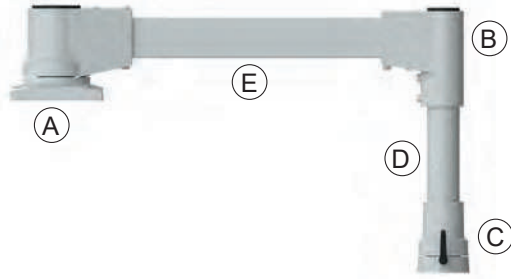

CONFIGURAZIONE 5
CONFIGURATION 5

RIF.	DESCRIZIONE DESCRIPTION	CODICE CODE	QUANTITÀ QUANTITY
A	Torretta rotante Rotating turret	R5SLSTR	1
B	Adattatore angol. Angle coupling	R5SLSAF	1
C	Snodo dritto Straight joint	R5SLSDF	1
D	Tubo circolare Circular pipe	R5SLTCX*	1
E	Tubo rettangolare Flat pipe	R5SLT6X*	1

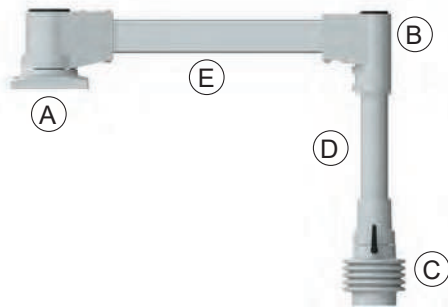

CONFIGURAZIONE 6
CONFIGURATION 6

RIF.	DESCRIZIONE DESCRIPTION	CODICE CODE	QUANTITÀ QUANTITY
A	Torretta rotante Rotating turret	R5SLSTR	1
B	Adattatore angol. Angle coupling	R5SLSAF	1
C	Snodo inclinabile Tilting joint	R5SLSDI	1
D	Tubo circolare Circular pipe	R5SLTCX*	1
E	Tubo rettangolare Flat pipe	R5SLT6X*	1

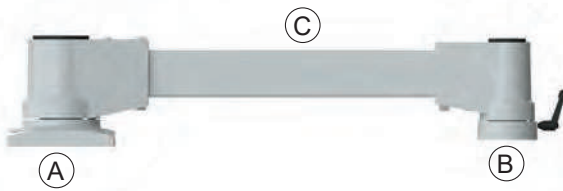

CONFIGURAZIONE 7
CONFIGURATION 7

RIF.	DESCRIZIONE DESCRIPTION	CODICE CODE	QUANTITÀ QUANTITY
A	Torretta rotante Rotating turret	R5SLSTR	1
B	Snodo 90° 90° joint	R5SLSRF	1
C	Tubo rettangolare Flat pipe	R5SLT6X*	1

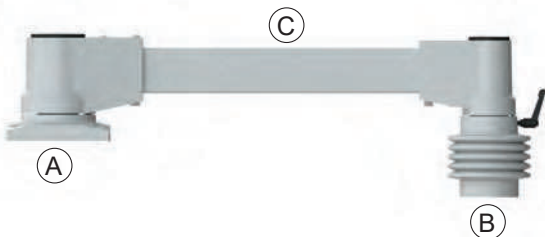

CONFIGURAZIONE 8
CONFIGURATION 8

RIF.	DESCRIZIONE DESCRIPTION	CODICE CODE	QUANTITÀ QUANTITY
A	Torretta rotante Rotating turret	R5SLSTR	1
B	Snodo 90° inclinab. Tilting 90° joint	R5SLSRI	1
C	Tubo rettangolare Flat pipe	R5SLT6X*	1

Sostituire X con il numero relativo alla lunghezza del tubo necessario: 5 per il tubo da 500 mm, 1 per il tubo da 1000 mm.
X is to be substituted by a number relative to the required pipe length: 5 for 500 mm pipe, 1 for 1000 mm pipe.

■ Sistema di sospensione a braccio portante serie LIGHT

LIGHT support arm system

Configurazioni con snodo attacco a parete

Configurations with wall-mounted joint

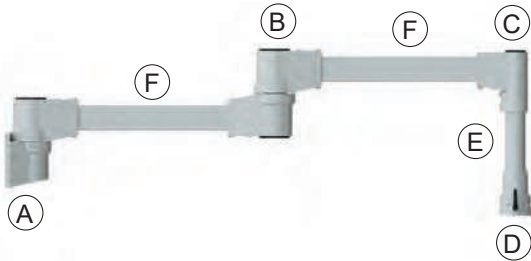

CONFIGURAZIONE 1
CONFIGURATION 1

RIF.	DESCRIZIONE DESCRIPTION	CODICE CODE	QUANTITÀ QUANTITY
A	Torretta rotante Rotating turret	R5SLSAP	1
B	Snodo intermedio Intermediate hinge	R5SLSIN	1
C	Adattatore angol. Angle coupling	R5SLSAF	1
D	Snodo dritto Tilting joint	R5SLSDF	1
E	Tubo circolare Circular pipe	R5SLTCX*	1
F	Tubo rettangolare Flat pipe	R5SLT6X*	2

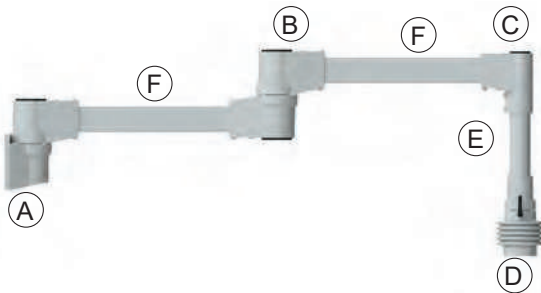

CONFIGURAZIONE 2
CONFIGURATION 2

RIF.	DESCRIZIONE DESCRIPTION	CODICE CODE	QUANTITÀ QUANTITY
A	Torretta rotante Rotating turret	R5SLSAP	1
B	Snodo intermedio Intermediate hinge	R5SLSIN	1
C	Adattatore angol. Angle coupling	R5SLSAF	1
D	Snodo inclinabile Tilting joint	R5SLSDI	1
E	Tubo circolare Circular pipe	R5SLTCX*	1
F	Tubo rettangolare Flat pipe	R5SLT6X*	2

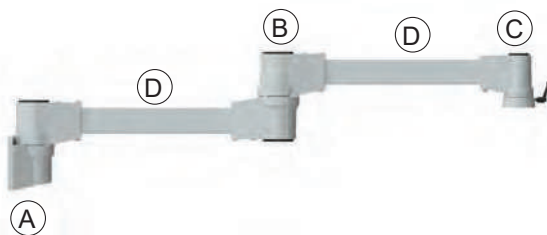

CONFIGURAZIONE 3
CONFIGURATION 3

RIF.	DESCRIZIONE DESCRIPTION	CODICE CODE	QUANTITÀ QUANTITY
A	Snodo attacco par. Rotating turret	R5SLSAP	1
B	Snodo intermedio Intermediate hinge	R5SLSIN	1
C	Snodo 90° Tilting 90° joint	R5SLSRF	1
D	Tubo rettangolare Flat pipe	R5SLT6X*	2

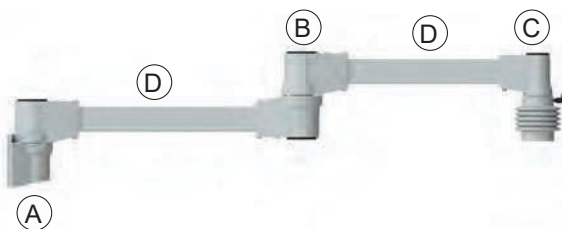

CONFIGURAZIONE 4
CONFIGURATION 4

RIF.	DESCRIZIONE DESCRIPTION	CODICE CODE	QUANTITÀ QUANTITY
A	Snodo attacco par. Rotating turret	R5SLSAP	1
B	Snodo intermedio Intermediate hinge	R5SLSIN	1
C	Snodo 90° inclinab. Tilting 90° joint	R5SLSRF	1
D	Tubo rettangolare Flat pipe	R5SLT6X*	2

Sostituire X con il numero relativo alla lunghezza del tubo necessario: 5 per il tubo da 500 mm, 1 per il tubo da 1000 mm.
X is to be substituted by a number relative to the required pipe length: 5 for 500 mm pipe, 1 for 1000 mm pipe.

■ Sistema di sospensione a braccio portante serie LIGHT LIGHT support arm system

Configurazioni con snodo attacco a parete Configurations with wall-mounted joint

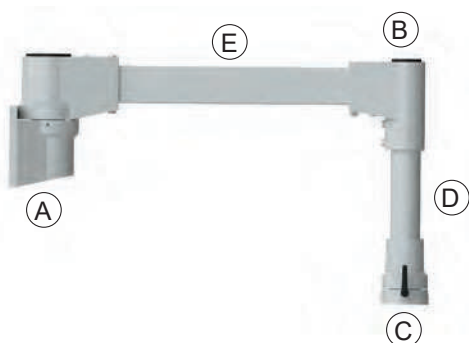

CONFIGURAZIONE 5
CONFIGURATION 5

RIF.	DESCRIZIONE DESCRIPTION	CODICE CODE	QUANTITÀ QUANTITY
A	Snodo attacco par. Rotating turret	R5SLSAP	1
B	Adattatore angol. Angle coupling	R5SLSAF	1
C	Snodo dritto Straight joint	R5SLSDF	1
D	Tubo circolare Circular pipe	R5SLTCX*	1
E	Tubo rettangolare Flat pipe	R5SLT6X*	1

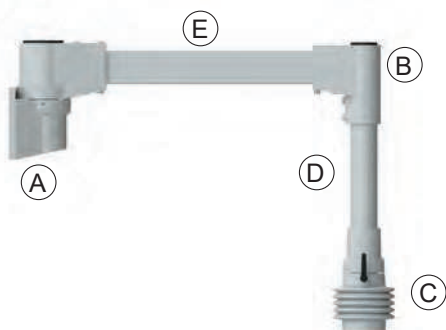

CONFIGURAZIONE 6
CONFIGURATION 6

RIF.	DESCRIZIONE DESCRIPTION	CODICE CODE	QUANTITÀ QUANTITY
A	Snodo attacco par. Rotating turret	R5SLSAP	1
B	Adattatore angol. Angle coupling	R5SLSAF	1
C	Snodo inclinabile Tilting joint	R5SLSDI	1
D	Tubo circolare Circular pipe	R5SLTCX*	1
E	Tubo rettangolare Flat pipe	R5SLT6X*	1



CONFIGURAZIONE 7
CONFIGURATION 7

RIF.	DESCRIZIONE DESCRIPTION	CODICE CODE	QUANTITÀ QUANTITY
A	Snodo attacco par. Rotating turret	R5SLSAP	1
B	Snodo 90° 90° joint	R5SLSRF	1
C	Tubo rettangolare Flat pipe	R5SLT6X*	1

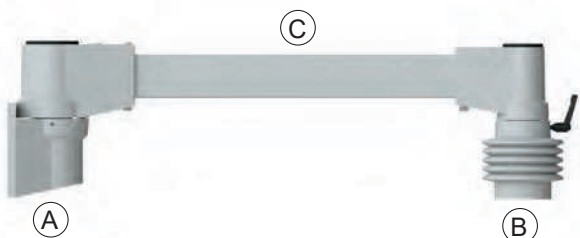

CONFIGURAZIONE 8
CONFIGURATION 8

RIF.	DESCRIZIONE DESCRIPTION	CODICE CODE	QUANTITÀ QUANTITY
A	Snodo attacco par. Rotating turret	R5SLSAP	1
B	Snodo 90° inclinab. Tilting 90° joint	R5SLSRI	1
C	Tubo rettangolare Flat pipe	R5SLT6X*	1

Sostituire X con il numero relativo alla lunghezza del tubo necessario: 5 per il tubo da 500 mm, 1 per il tubo da 1000 mm.
X is to be substituted by a number relative to the required pipe length: 5 for 500 mm pipe, 1 for 1000 mm pipe.

■ Sistema di sospensione a braccio portante serie LIGHT

LIGHT support arm system

Configurazioni con partenza da terra

Configurations with ground starting

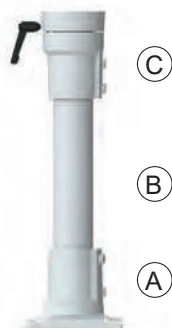

CONFIGURAZIONE 1
CONFIGURATION 1

RIF.	DESCRIZIONE DESCRIPTION	CODICE CODE	QUANTITÀ QUANTITY
A	Giunto da terra Ground joint	R5SLGPT48	1
B	Tubo circolare Circular pipe	R5SLTCX	1
C	Snodo dritto Straight joint	R5SLSDF	1



CONFIGURAZIONE 2
CONFIGURATION 2

RIF.	DESCRIZIONE DESCRIPTION	CODICE CODE	QUANTITÀ QUANTITY
A	Giunto da terra Ground joint	R5SLGPT48	1
B	Tubo circolare Circular pipe	R5SLTCX	1
C	Snodo dritto Straight joint	R5SLSDI	1

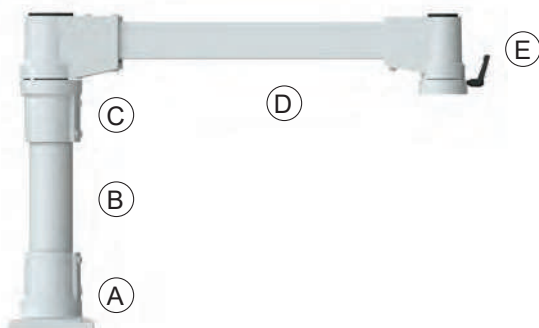

CONFIGURAZIONE 3
CONFIGURATION 3

RIF.	DESCRIZIONE DESCRIPTION	CODICE CODE	QUANTITÀ QUANTITY
A	Giunto da terra Ground joint	R5SLGPT70	1
B	Tubo circolare Circular pipe	R5SLTC7X	1
C	Adattatore angol. Angle coupling	R5SLSAF	1
D	Tubo rettangolare Flat pipe	R5SLT6X*	1
E	Snodo 90° 90° joint	R5SLSRF	1

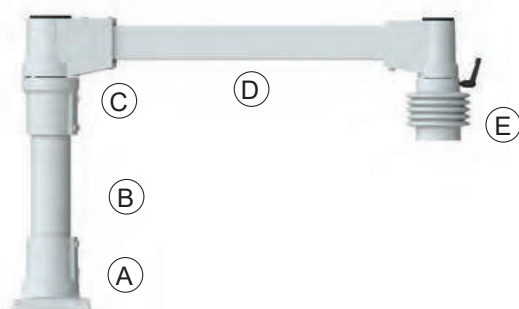

CONFIGURAZIONE 4
CONFIGURATION 4

RIF.	DESCRIZIONE DESCRIPTION	CODICE CODE	QUANTITÀ QUANTITY
A	Giunto da terra Ground joint	R5SLGPT70	1
B	Tubo circolare Circular pipe	R5SLTC7X	1
C	Adattatore angol. Angle coupling	R5SLSAF	1
D	Tubo rettangolare Flat pipe	R5SLT6X*	1
E	Snodo 90° inclinab. Tilting 90° joint	R5SLSRI	1

Sostituire X con il numero relativo alla lunghezza del tubo necessario: 5 per il tubo da 500 mm, 1 per il tubo da 1000 mm.
X is to be substituted by a number relative to the required pipe length: 5 for 500 mm pipe, 1 for 1000 mm pipe.

■ Sistema di sospensione a braccio portante serie LIGHT

LIGHT support arm system

Configurazioni con snodo attacco a parete

Configurations with wall-mounted joint

CONFIGURAZIONE 5
CONFIGURATION 5

RIF.	DESCRIZIONE DESCRIPTION	CODICE CODE	QUANTITÀ QUANTITY
A	Giunto da terra Ground joint	R5SLGPT70	1
B	Tubo circolare Circular pipe	R5SLTC7X	1
C	Adattatore angol. Angle coupling	R5SLSAV	1
D	Tubo rettangolare Flat pipe	R5SLT6X*	1
E	Adattatore angol. Angle coupling	R5SLSAF	1
F	Tubo circolare Circular pipe	R5SLTCX	1
G	Snodo dritto Straight joint	R5SLSDF	1

CONFIGURAZIONE 6
CONFIGURATION 6

RIF.	DESCRIZIONE DESCRIPTION	CODICE CODE	QUANTITÀ QUANTITY
A	Giunto da terra Ground joint	R5SLGPT70	1
B	Tubo circolare Circular pipe	R5SLTC7X	1
C	Adattatore angol. Angle coupling	R5SLSAV	1
D	Tubo rettangolare Flat pipe	R5SLT6X*	1
E	Adattatore angol. Angle coupling	R5SLSAF	1
F	Tubo circolare Circular pipe	R5SLTCX	1
G	Snodo inclinabile Tilting joint	R5SLSDI	1

CONFIGURAZIONE 7
CONFIGURATION 7

RIF.	DESCRIZIONE DESCRIPTION	CODICE CODE	QUANTITÀ QUANTITY
A	Giunto da terra Ground joint	R5SLGPT70	1
B	Tubo circolare Circular pipe	R5SLTC7X	1
C	Adattatore angol. Angle coupling	R5SLSAVR	1
D	Tubo rettangolare Flat pipe	R5SLT6X*	1
E	Adattatore angol. Angle coupling	R5SLSAF	1
F	Tubo circolare Circular pipe	R5SLTCX	1
G	Snodo dritto Straight joint	R5SLSDF	1

CONFIGURAZIONE 8
CONFIGURATION 8

RIF.	DESCRIZIONE DESCRIPTION	CODICE CODE	QUANTITÀ QUANTITY
A	Giunto da terra Ground joint	R5SLGPT70	1
B	Tubo circolare Circular pipe	R5SLTC7X	1
C	Adattatore angol. Angle coupling	R5SLSAVR	1
D	Tubo rettangolare Flat pipe	R5SLT6X*	1
E	Adattatore angol. Angle coupling	R5SLSAF	1
F	Tubo circolare Circular pipe	R5SLTCX	1
G	Snodo inclinabile Tilting joint	R5SLSDI	1

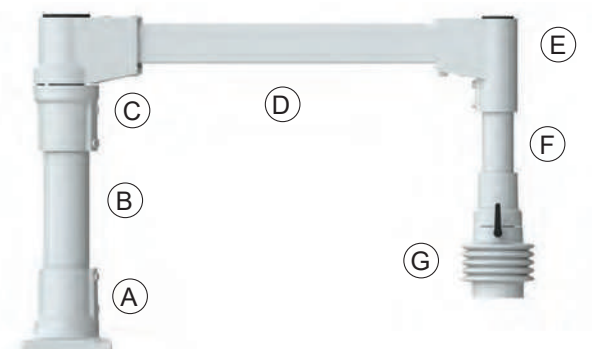
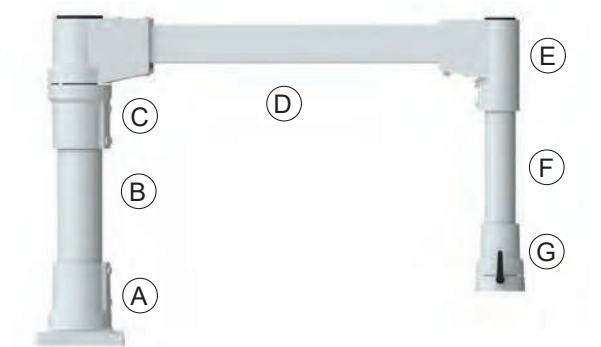
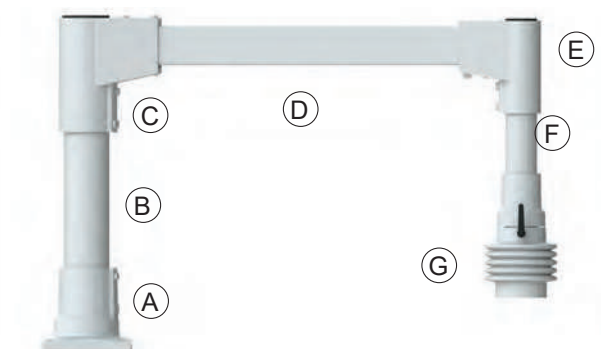
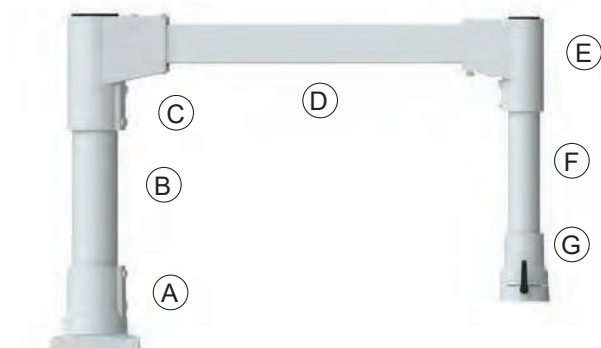

Sostituire X con il numero relativo alla lunghezza del tubo necessario: 5 per il tubo da 500 mm, 1 per il tubo da 1000 mm.
X is to be substituted by a number relative to the required pipe length: 5 for 500 mm pipe, 1 for 1000 mm pipe.

■ Sistema Light Light system

Giunto con partenza da terra per tubo diam.48mm Joint from ground for pipe diam. 48mm

Per la partenza da terra e/o da superfici orizzontali. Utilizzare in abbinamento al tubo circolare diam. 70 mm.

For starting from the ground and/or horizontal surfaces. To be used in combination with the circular pipe diam. 70 mm.



CODICE CODE	DIMENSIONI, MM DIMENSIONS, MM
R5SLGPT48	PESO NETTO (kg) NET WEIGHT (kg) 0,7

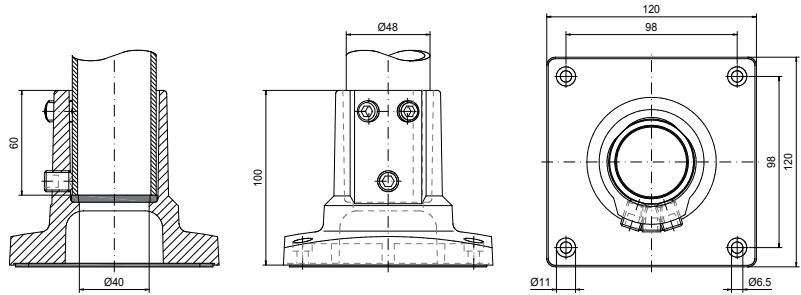

■ Sistema Light Light system

Giunto con partenza da terra per tubo diam.70mm Joint from ground for pipe diam. 70mm

Per la partenza da terra e/o da superfici orizzontali. Utilizzare in abbinamento al tubo circolare diam. 70 mm.

For starting from the ground and/or horizontal surfaces. To be used in combination with the circular pipe diam. 70 mm.



CODICE CODE	DIMENSIONI, MM DIMENSIONS, MM PESO NETTO (kg) NET WEIGHT (kg)
R5SLGPT70	1,150

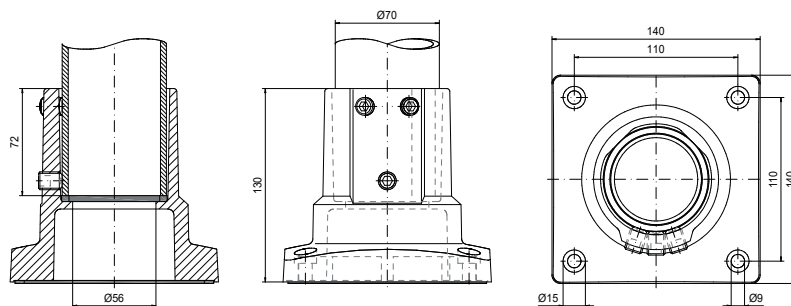

■ Sistema Light Light system

Snodo torretta rotante Rotating turret

Per il fissaggio al tetto dell'armadio e/o a superfici orizzontali. Utilizzare in abbinamento al tubo rettangolare 60x40 mm. Tappo in materiale plastico colore RAL 9005.

Purposed for fastening to the enclosure roof and/or horizontal surfaces. To be used in combination with the rectangular 60x40 mm. tube. Plastic material plug color RAL 9005



CODICE CODE	PESO NETTO (kg) NET WEIGHT (kg)	DIMENSIONI, MM DIMENSIONS, MM	ANGOLO ANGLE
R5SLSTR	2,45		300°

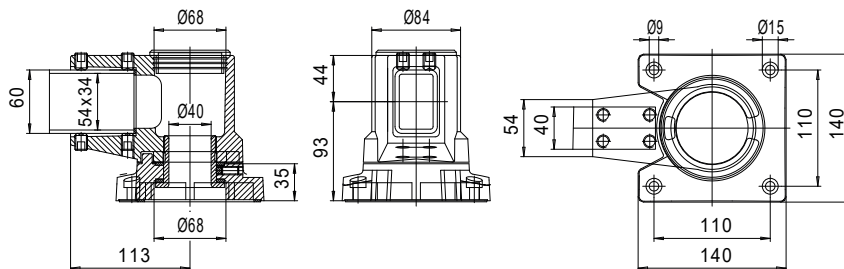

■ Sistema Light

Light system

Snodo attacco parete

Wall mount hinge

Per il fissaggio alla parete dell'armadio e/o a superfici verticali. Utilizzare in abbinamento al tubo rettangolare 60x40 mm.

Purposed for fastening to an enclosure wall and/or vertical surfaces. To be used in combination with 60x40 mm flat pipe.



CODICE CODE	PESO NETTO (kg) NET WEIGHT (kg)	DIMENSIONI, MM DIMENSIONS, MM	ANGOLO ANGLE
R5SLSAP	2,75		186°



■ Sistema Light

Light system

Adattatore angolare 90° 90 degrees angle coupling

Per collegare l'elemento orizzontale con quello verticale del sistema braccio.
Utilizzare in abbinamento ai tubi quadrati 50x50 mm.

Purposed to join horizontal and vertical elements of an arm system. To be used in combination with 50x50 mm square pipes.



CODICE CODE	DIMENSIONI, MM DIMENSIONS, MM PESO NETTO (kg) NET WEIGHT (kg)
R5LSAF	0,8

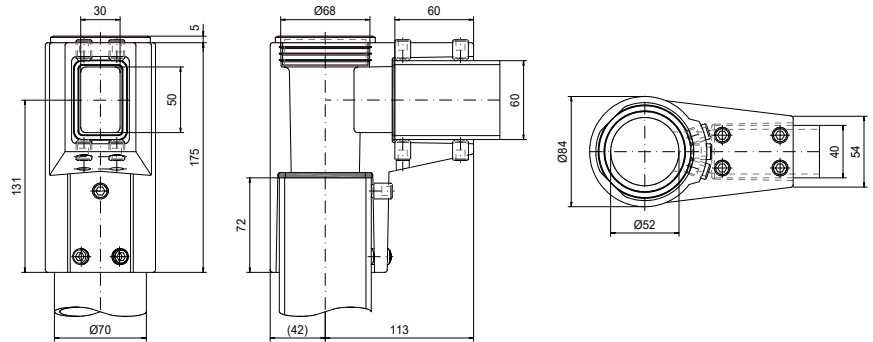

■ Sistema Light Light system

Adattatore angolare 90° 60X40 - Diam. 70 mm 90 degrees angle coupling 60X40 - 70 mm diam.

Per collegare l'elemento orizzontale con quello verticale del sistema braccio. Utilizzare in abbinamento al tubo rettangolare 60x40 mm (parte orizzontale) e al tubo circolare diam. 70 mm (parte verticale).

Purposed to join horizontal and vertical elements of an arm system. To be used in combination with 60x40 mm flat pipe (horizontal part) and circular pipe diam. 70 mm (vertical part).



CODICE CODE	DIMENSIONI, MM DIMENSIONS, MM PESO NETTO (kg) NET WEIGHT (kg)
R5SLSAV	2,3

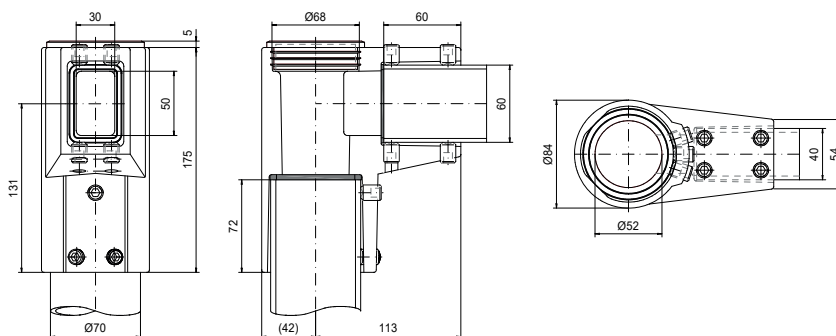

■ Sistema Light Light system

Adattatore angolare 90° rotante 60X40 - Diam. 70 mm 90 degrees angle coupling rotating 60X40 - 70 mm diam.

Per collegare l'elemento orizzontale con quello verticale del sistema braccio. Utilizzare in abbinamento al tubo rettangolare 60x40 mm (parte orizzontale) e al tubo circolare diam. 70 mm (parte verticale).

Purposed to join horizontal and vertical elements of an arm system. To be used in combination with 60x40 mm flat pipe (horizontal part) and circular pipe diam. 70mm (vertical part).

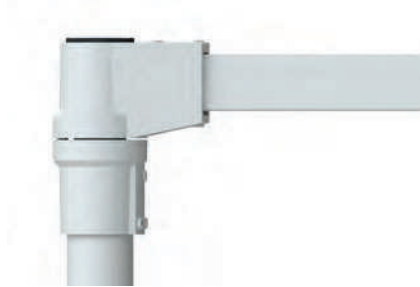

CODICE CODE	DIMENSIONI, MM DIMENSIONS, MM PESO NETTO (kg) NET WEIGHT (kg)
R5LSAVR	2,3

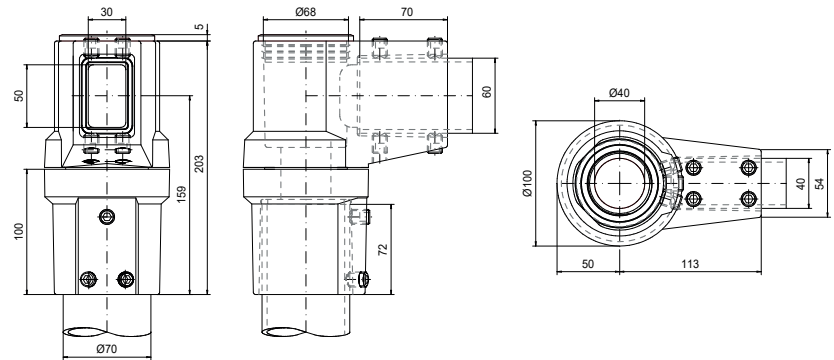

■ Sistema Light Light system

Snodo dritto diametro 48 mm Straight joint Ø 48 mm



Per collegare il contenitore alla parte verticale del sistema braccio. Utilizzare in abbinamento al tubo circolare diam. 48 mm.

Purposed to connect an enclosure to the vertical part of an arm system. To be used in combination with Ø 48 mm circular pipe.

CODICE CODE	PESO NETTO (kg) NET WEIGHT (kg)	DIMENSIONI, MM DIMENSIONS, MM	ANGOLO ANGLE
R5LSDF	0,48		300°

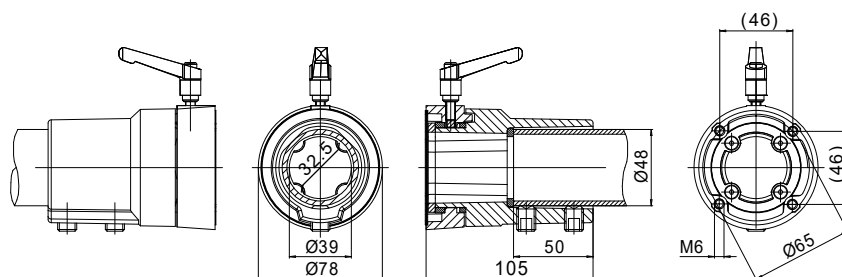

■ Sistema Light Light system

Snodo dritto diametro 48 mm inclinabile Tilting straight joint Ø 48 mm



Per collegare il contenitore alla parte verticale del sistema braccio. Utilizzare in abbinamento al tubo circolare diam. 48 mm. Permette l'inclinazione del contenitore di circa 50°.

Purposed to connect an enclosure to the vertical part of an arm system. To be used in combination with Ø 48 mm circular pipe.

CODICE CODE	PESO NETTO (kg) NET WEIGHT (kg)	DIMENSIONI, MM	ANGOLO ANGLE
		DIMENSIONS, MM	
R5LSDI	1,35		300°

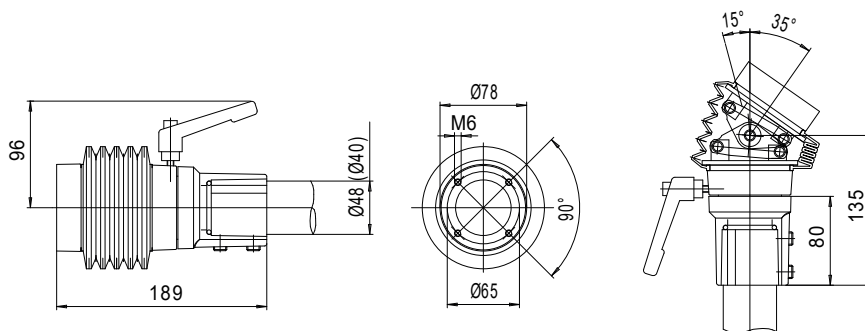

■ Sistema Light Light system

Snodo intermedio Intermediate hinge



Permette di accoppiare più elementi orizzontali del sistema braccio, consentendone la rotazione. Utilizzare in abbinamento ai tubi rettangolari 60x40 mm. Tappo in materiale plastico colore RAL 9005

Allows coupling several horizontal elements of an arm system providing its rotation. To be used in combination with 60x40 mm flat pipes. Plastic material plug color RAL 9005

CODICE CODE	PESO NETTO (kg) NET WEIGHT (kg)	DIMENSIONI, MM DIMENSIONS, MM	ANGOLO ANGLE
R5SLSIN	3		300°

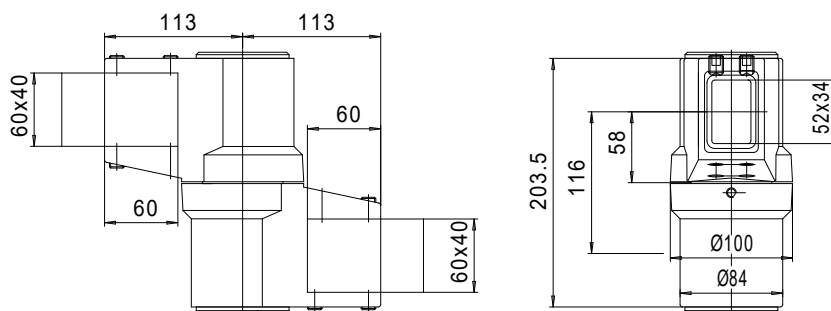

■ Sistema Light Light system

Snodo 90° 60x40 90° joint 60x40

Permette il fissaggio del contenitore direttamente alla parte orizzontale del sistema braccio. Utilizzare in abbinamento al tubo rettangolare 60x40 mm.

Allows fastening an enclosure directly to the horizontal part of an arm system. To be used in combination with 60x40 mm flat pipe.

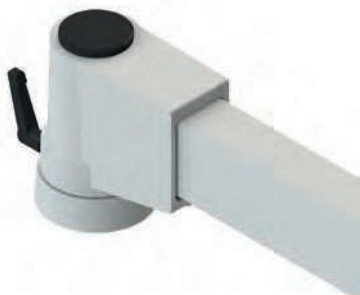

CODICE CODE	PESO NETTO (kg) NET WEIGHT (kg)	DIMENSIONI, MM DIMENSIONS, MM	ANGOLO ANGLE
R5LSLRF	1,1		300°

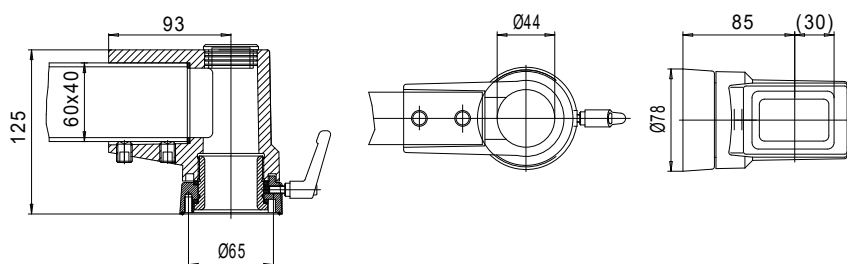

■ Sistema Light Light system

Snodo 90° 60x40 inclinabile Tilting 90° joint 60x40

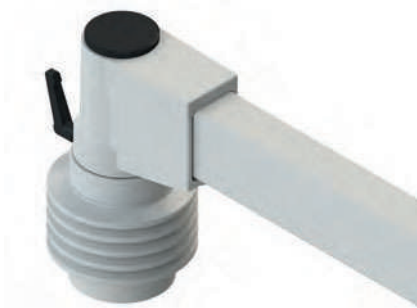

Permette il fissaggio del contenitore direttamente alla parte orizzontale del sistema braccio. Utilizzare in abbinamento al tubo rettangolare 60x40 mm. Permette l'inclinazione del contenitore di circa 50°.

Allows fastening an enclosure directly to the horizontal part of an arm system. To be used in combination with 60x40 mm flat pipe. Permits the enclosure to be tilted by approximately 50°.

CODICE CODE	PESO NETTO (kg) NET WEIGHT (kg)	DIMENSIONI, MM DIMENSIONS, MM	ANGOLO ANGLE
R5SLSRI	1,8		300°

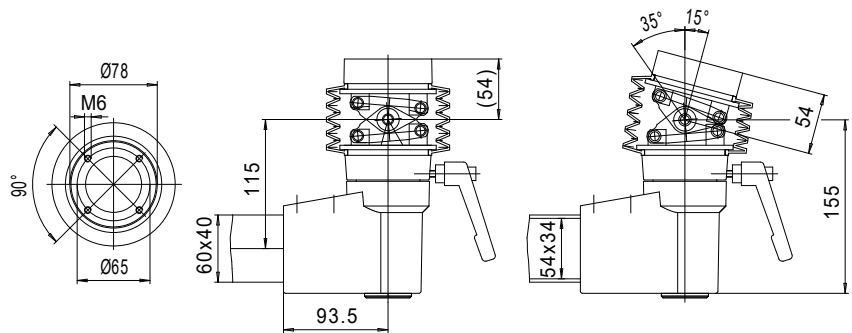

■ Sistema Light Light system

Tubo rettangolare 60x40 mm 60x40 mm square tube

Utilizzare per la composizione del sistema braccio orizzontale. In fase di installazione il tubo può essere tagliato e riutilizzato in base alle esigenze senza ulteriori lavorazioni.

To be used to arrange horizontal arm systems. During the installation this pipe can be cut and reemployed as required with no additional treatments.

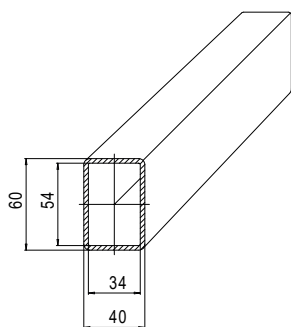

CODICE CODE	PESO NETTO (kg) NET WEIGHT (kg)	DIMENSIONI, MM DIMENSIONS, MM	
		LUNGHEZZA LENGTH	SPESSORE THICKNESS
R5SLT61	4,3	1000	
R5SLT65	2,15	500	4

■ Sistema Light Light system

Tubo circolare d.48mm Circular pipe 48 mm diameter



Utilizzare per la composizione del sistema braccio orizzontale. In fase di installazione il tubo può essere tagliato e riutilizzato in base alle esigenze senza ulteriori lavorazioni.

To be used to arrange horizontal arm parts composition. During the installation this pipe can be cut and reemployed as required with no additional treatments.

CODICE CODE	PESO NETTO (kg) NET WEIGHT (kg)	DIMENSIONI, MM DIMENSIONS, MM	
		SPESSORE THICKNESS	LUNGHEZZA LENGTH
R5SLTC1	3,6	3	1000
R5SLTC5	1,61		500

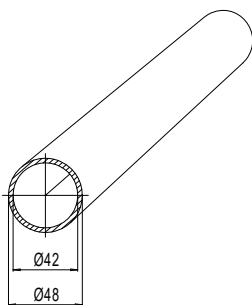

■ Sistema Light Light system

Tubo circolare d.70mm Circular pipe 70 mm diameter



Utilizzare per la composizione del sistema braccio orizzontale. In fase di installazione il tubo può essere tagliato e riutilizzato in base alle esigenze senza ulteriori lavorazioni.

To be used to arrange horizontal arm parts composition. During the installation this pipe can be cut and reemployed as required with no additional treatments.

CODICE CODE	PESO NETTO (kg) NET WEIGHT (kg)	DIMENSIONI, MM DIMENSIONS, MM	
		LUNGHEZZA LENGTH	SPESSORE THICKNESS
R5SLTC71	5,25	1000	3
R5SLTC75	2,35	500	

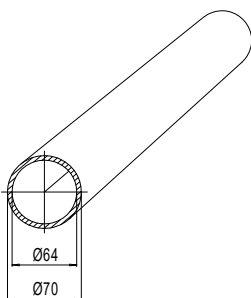

■ Sistema Light

Light system

Staffa rinforzo per giunto a parete sistema LIGHT

Reinforcement bracket for LIGHT system wall mount hinge joint



In lamiera d'acciaio elettrozincata, spessore 20/10.

Da montare esclusivamente all'interno degli armadi in abbinamento ai profili laterali RZPDL (catalogo DKC RAMBLOCK).

Utilizzabili con armadi serie CQE e CAE.

20/10 thick galvanized sheet steel.

To be mounted exclusively in combination with RZPDL side rails (DKC RAMBLOCK Catalogue).

Suitable for CQE, and CAE enclosures.

CODICE CODE	DIMENSIONI, MM DIMENSIONS, MM DIMENSIONE (mm) DIMENSION (mm)
RZSLRSAP	55x150x150

Staffa rinforzo torretta rotante sistema Light

Reinforcement bracket for Light system rotating turret joint

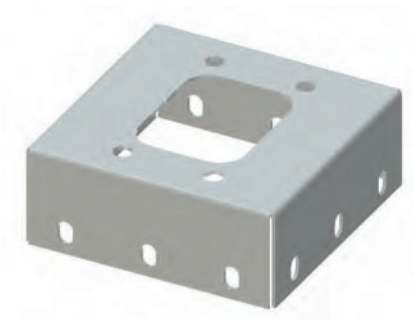

In lamiera d'acciaio elettrozincata, spessore 20/10.

Da montare esclusivamente all'interno degli armadi in abbinamento ai profili laterali RZPDL (catalogo DKC RAMBLOCK).

Utilizzabili con armadi serie CQE e CAE.

20/10 thick galvanized sheet steel.

To be mounted exclusively in combination with RZPDL side rails (DKC RAMBLOCK Catalogue).

Suitable for CQE, and CAE enclosures.

CODICE CODE	DIMENSIONI, MM DIMENSIONS, MM DIMENSIONE (mm) DIMENSION (mm)
RZSLRSTR	55x150x150

Piastra di rinforzo per contenitore per sistema LIGHT

Reinforcement plate for enclosures purposed for LIGHT system

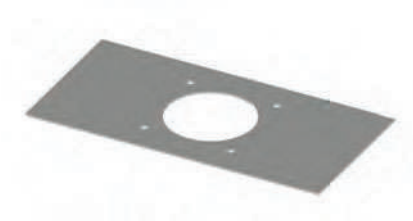

In lamiera d'acciaio elettrozincata, spessore 20/10.

Da montare esclusivamente all'interno dei contenitori serie ALUFRAME.

Utilizzabili anche per le casse serie CE, CLE, CDE (previa verifica dimensioni).

20/10 thick galvanized sheet steel.

To assemble exclusively inside ALUFRAME enclosures.

Suitable also for CE, CLE, CDE (subject to verification of enclosure dimensions).

CODICE CODE	LARGHEZZA (mm) WIDTH (mm)	DIMENSIONI, MM DIMENSIONS, MM PROFONDITÀ (mm) DEPTH (mm)
RZSLPR	290	130

■ Sistema di sospensione a braccio portante serie MEDIUM

MEDIUM support arm system

Caratteristiche Specifications

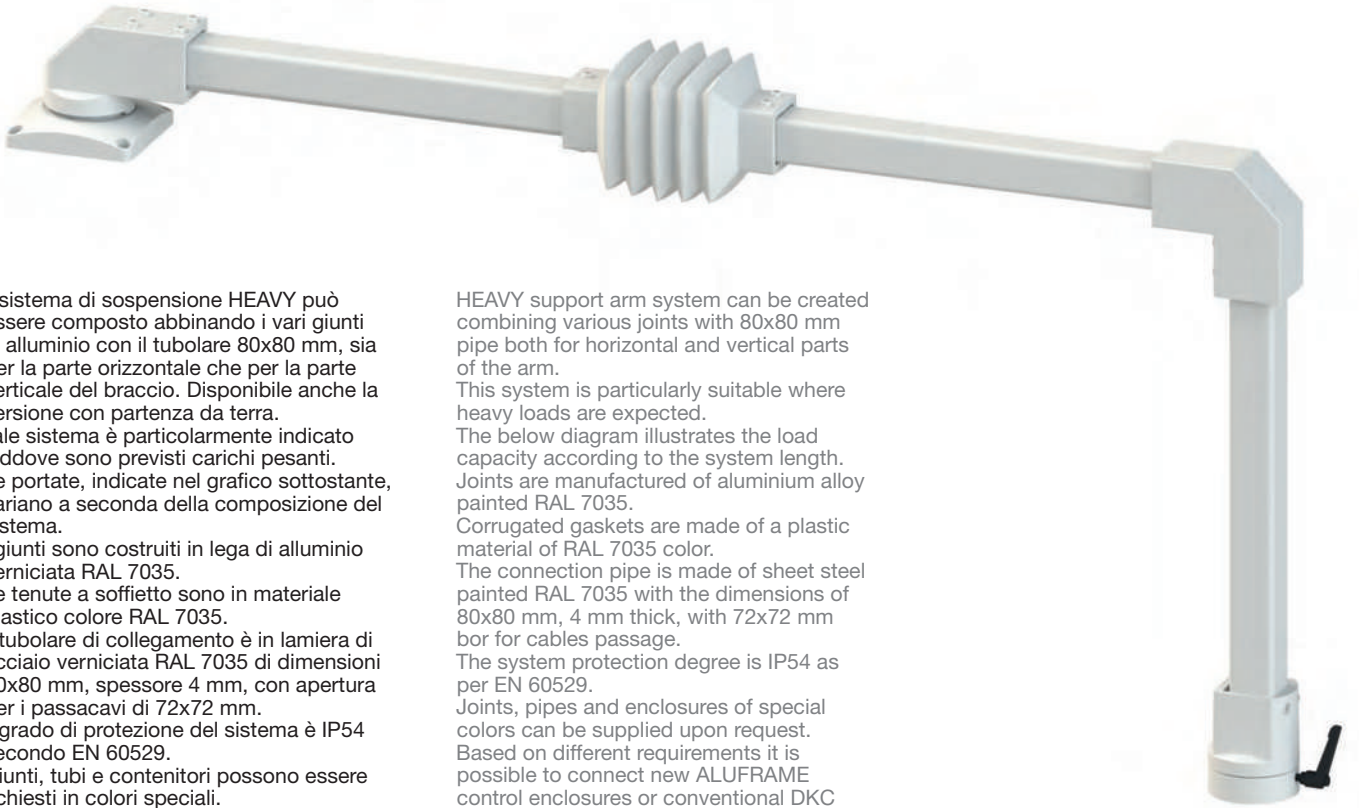

Il sistema di sospensione HEAVY può essere composto abbinando i vari giunti in alluminio con il tubolare 80x80 mm, sia per la parte orizzontale che per la parte verticale del braccio. Disponibile anche la versione con partenza da terra. Tale sistema è particolarmente indicato laddove sono previsti carichi pesanti. Le portate, indicate nel grafico sottostante, variano a seconda della composizione del sistema. I giunti sono costruiti in lega di alluminio verniciata RAL 7035. Le tenute a soffietto sono in materiale plastico colore RAL 7035. Il tubolare di collegamento è in lamiera di acciaio verniciata RAL 7035 di dimensioni 80x80 mm, spessore 4 mm, con apertura per i passacavi di 72x72 mm. Il grado di protezione del sistema è IP54 secondo EN 60529. Giunti, tubi e contenitori possono essere richiesti in colori speciali. In base alle diverse esigenze, è possibile collegare i nuovi contenitori di comando serie ALUFRAME oppure le tradizionali casse DKC serie CE, CLE e CDE.

HEAVY support arm system can be created combining various joints with 80x80 mm pipe both for horizontal and vertical parts of the arm. This system is particularly suitable where heavy loads are expected. The below diagram illustrates the load capacity according to the system length. Joints are manufactured of aluminium alloy painted RAL 7035. Corrugated gaskets are made of a plastic material of RAL 7035 color. The connection pipe is made of sheet steel painted RAL 7035 with the dimensions of 80x80 mm, 4 mm thick, with 72x72 mm bor for cables passage. The system protection degree is IP54 as per EN 60529. Joints, pipes and enclosures of special colors can be supplied upon request. Based on different requirements it is possible to connect new ALUFRAME control enclosures or conventional DKC boxes of CE, CLE and CDE series.

CARATTERISTICHE TECNICHE

- Materiale giunti: Lega di alluminio verniciata RAL 7035.
- Materiale tubi: Acciaio verniciato RAL 7035.
- Colore soffietti: RAL 7035.
- Grado di protezione: IP 54

TECHNICAL SPECIFICATIONS

- Material of joints: Aluminium alloy painted RAL 7035.
- Material of pipes: Steel painted RAL 7035.
- Corrugated gaskets color: RAL 7035.
- Protection degree: IP 54

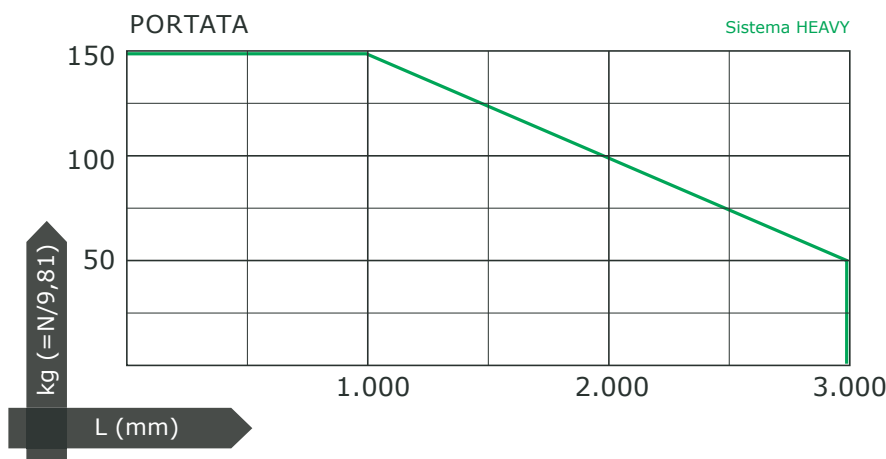

■ Sistema di sospensione a braccio portante serie MEDIUM

MEDIUM support arm system

Configurazioni con torretta rotante

Configuration with rotating turret

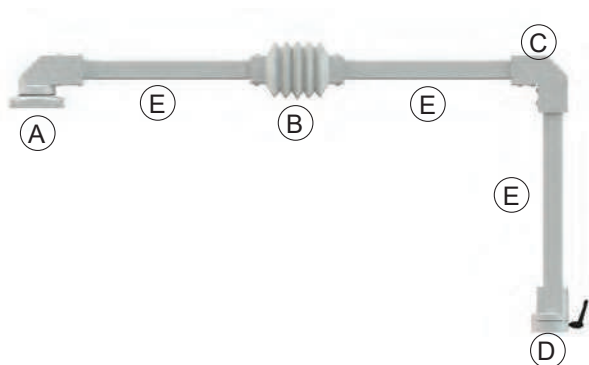

CONFIGURAZIONE 1
CONFIGURATION 1

RIF.	DESCRIZIONE DESCRIPTION	CODICE CODE	QUANTITÀ QUANTITY
A	Torretta rotante Rotating turret	R5SMSTR	1
B	Snodo intermedio Intermediate hinge	R5SMSIN	1
C	Adattatore angol. Angle coupling	R5SMSAF	1
D	Snodo dritto Straight joint	R5SMSDF	1
E	Tubo quadro Square pipe	R5SLT5X*	3

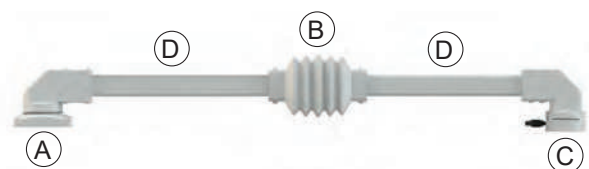

CONFIGURAZIONE 2
CONFIGURATION 2

RIF.	DESCRIZIONE DESCRIPTION	CODICE CODE	QUANTITÀ QUANTITY
A	Torretta rotante Rotating turret	R5SMSTR	1
B	Giunto intermedio Intermediate joint	R5SMSIN	1
C	Snodo rotante Rotating joint	R5SMSRF	1
D	Tubo quadro Square pipe	R5SLT5X*	2

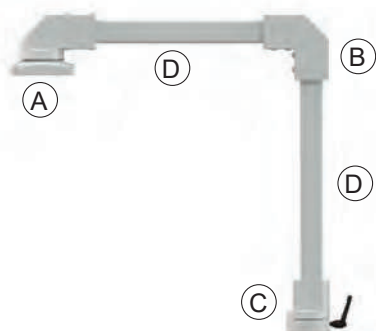

CONFIGURAZIONE 3
CONFIGURATION 3

RIF.	DESCRIZIONE DESCRIPTION	CODICE CODE	QUANTITÀ QUANTITY
A	Torretta rotante Rotating turret	R5SMSTR	1
B	Adattatore angol. Angle coupling	R5SMSAF	1
C	Snodo dritto Straight joint	R5SMSDF	1
D	Tubo quadro Square pipe	R5SLT5X*	2

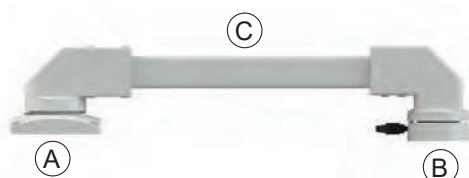

CONFIGURAZIONE 4
CONFIGURATION 4

RIF.	DESCRIZIONE DESCRIPTION	CODICE CODE	QUANTITÀ QUANTITY
A	Torretta rotante Rotating turret	R5SMSTR	1
B	Snodo rotante Rotating joint	R5SMSRF	1
C	Tubo quadro Square pipe	R5SLT5X*	1

Sostituire X con il numero relativo alla lunghezza del tubo necessario: 5 per il tubo da 500 mm, 1 per il tubo da 1000 mm, 2 per il tubo da 2000 mm.
X is to be substituted by a number relative to the required pipe length: 5 for 500 mm pipe, 1 for 1000 mm pipe, 2 for 2000 mm pipe.

■ Sistema di sospensione a braccio portante serie MEDIUM

MEDIUM support arm system

Configurazioni con giunto a parete Configuration with wall mount joint

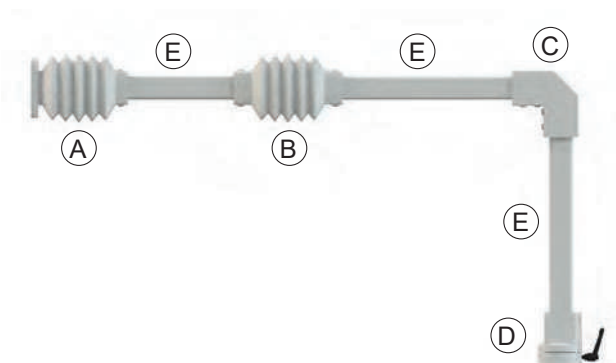

CONFIGURAZIONE 5
CONFIGURATION 5

RIF.	DESCRIZIONE DESCRIPTION	CODICE CODE	QUANTITÀ QUANTITY
A	Giunto a parete Wall mount joint	R5SMSAP	1
B	Giunto intermedio Intermediate joint	R5SMSIN	1
C	Adattatore angol. Angle coupling	R5SMSAF	1
D	Snodo dritto Straight joint	R5SMSDF	1
E	Tubo quadro Square pipe	R5SLT5X*	3

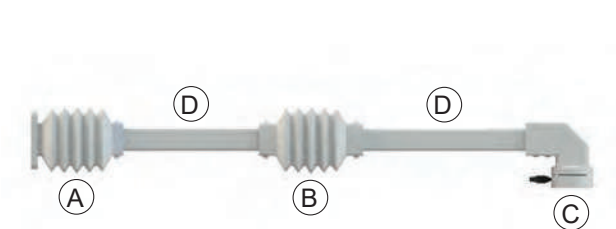

CONFIGURAZIONE 6
CONFIGURATION 6

RIF.	DESCRIZIONE DESCRIPTION	CODICE CODE	QUANTITÀ QUANTITY
A	Giunto a parete Wall mount joint	R5SMSAP	1
B	Giunto intermedio Intermediate joint	R5SMSIN	1
C	Snodo rotante Rotating joint	R5SMSRF	1
D	Tubo quadro Square pipe	R5SLT5X*	2

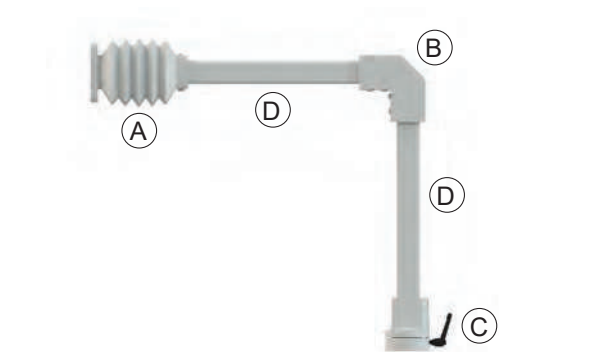

CONFIGURAZIONE 7
CONFIGURATION 7

RIF.	DESCRIZIONE DESCRIPTION	CODICE CODE	QUANTITÀ QUANTITY
A	Giunto a parete Wall mount joint	R5SMSAP	1
B	Adattatore angol. Angle coupling	R5SMSAF	1
C	Snodo dritto Straight joint	R5SMSDF	1
D	Tubo quadro Square pipe	R5SLT5X*	2

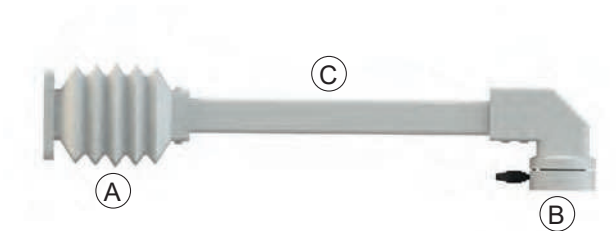

CONFIGURAZIONE 8
CONFIGURATION 8

RIF.	DESCRIZIONE DESCRIPTION	CODICE CODE	QUANTITÀ QUANTITY
A	Giunto a parete Wall mount joint	R5SMSAP	1
B	Snodo rotante Rotating joint	R5SMSRF	1
C	Tubo quadro Square pipe	R5SLT5X*	1

Sostituire X con il numero relativo alla lunghezza del tubo necessario: 5 per il tubo da 500 mm, 1 per il tubo da 1000 mm, 2 per il tubo da 2000 mm.
X is to be substituted by a number relative to the required pipe length: 5 for 500 mm pipe, 1 for 1000 mm pipe, 2 for 2000 mm pipe.

■ Sistema di sospensione a braccio portante serie MEDIUM MEDIUM support arm system

Configurazioni con partenza da terra
Configuration options with starts from ground

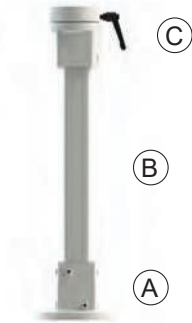

CONFIGURAZIONE 1
CONFIGURATION 1

RIF.	DESCRIZIONE DESCRIPTION	CODICE CODE	QUANTITÀ QUANTITY
A	Giunto da terra Ground joint	R5SMGPT50	1
B	Tubo quadro Square pipe	R5SLT5X*	1
C	Snodo dritto Straight joint	R5SMSDF	1

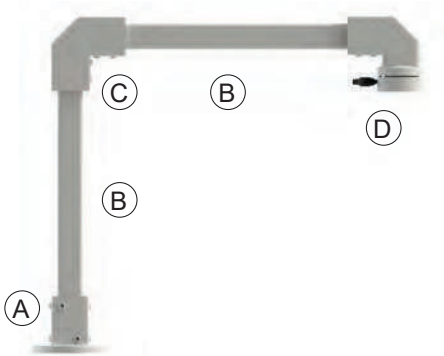

CONFIGURAZIONE 2
CONFIGURATION 2

RIF.	DESCRIZIONE DESCRIPTION	CODICE CODE	QUANTITÀ QUANTITY
A	Giunto da terra Ground joint	R5SMGPT50	1
B	Tubo quadro Square pipe	R5SLT5X*	2
C	Adattatore angol. Angle coupling	R5SMSAF	1
D	Snodo rotante Rotating joint	R5SMSRF	1

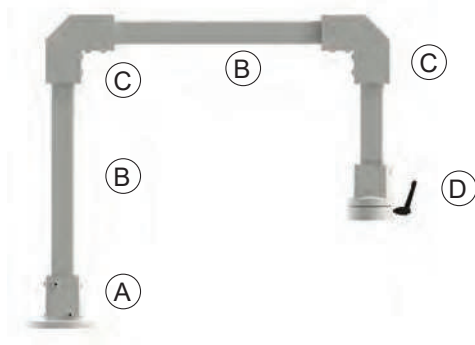

CONFIGURAZIONE 3
CONFIGURATION 3

RIF.	DESCRIZIONE DESCRIPTION	CODICE CODE	QUANTITÀ QUANTITY
A	Giunto da terra Ground joint	R5SMGPT50	1
B	Tubo quadro Square pipe	R5SLT5X*	2
C	Adattatore angol. Angle coupling	R5SMSAF	2
D	Snodo dritto Straight joint	R5SMSDF	1

Sostituire X con il numero relativo alla lunghezza del tubo necessario: 5 per il tubo da 500 mm, 1 per il tubo da 1000 mm, 2 per il tubo da 2000 mm.
X is to be substituted by a number relative to the required pipe length: 5 for 500 mm pipe, 1 for 1000 mm pipe, 2 for 2000 mm pipe.

■ Sistema Medium Medium system

Giunto con partenza da terra Joint from ground

Per la partenza da terra e/o da superfici orizzontali. Utilizzare in abbinamento al tubo quadrato 50x50 mm.

For starting from the ground and/or horizontal surfaces. To be used in conjunction with square tube 50x50 mm.



CODICE CODE	DIMENSIONI, MM DIMENSIONS, MM PESO NETTO (kg) NET WEIGHT (kg)
R5SMGPT50	3,25

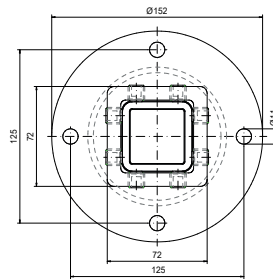
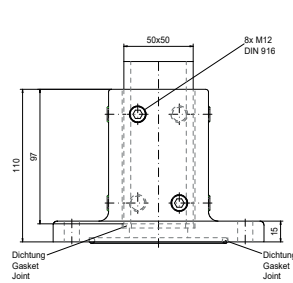

■ Sistema Medium Medium system

Giunto a parete Wall mount joint

Per il fissaggio alla parete dell'armadio e/o a superfici verticali. Utilizzare in abbinamento al tubo quadrato 50x50 mm.

Purposed for fastening to an enclosure wall and/or horizontal surfaces. To be used in combination with a 50x50 mm square pipe.

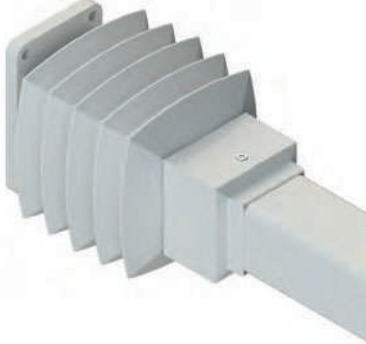

CODICE CODE	PESO NETTO (kg) NET WEIGHT (kg)	DIMENSIONI, MM	ANGOLO ANGLE
		DIMENSIONS, MM	
R5SMSAP	4,35		170°

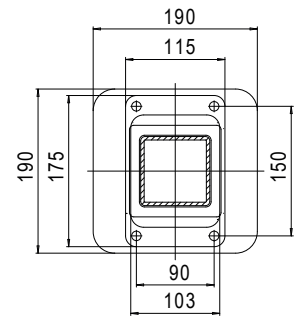
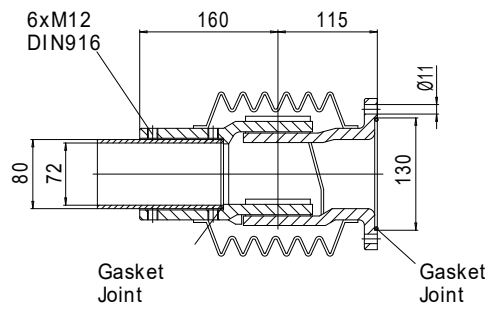

■ Sistema Medium Medium system

Giunto intermedio Intermediate joint

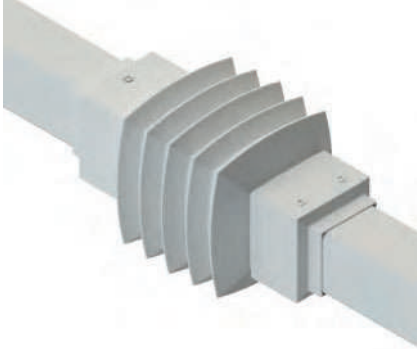

Permette di accoppiare più elementi orizzontali del sistema braccio, consentendone la rotazione. Utilizzare in abbinamento ai tubi quadrati 50x50 mm.

Allows coupling several horizontal elements of an arm system providing its rotation. To be used in combination with 50x50 mm square pipes.

CODICE CODE	PESO NETTO (kg) NET WEIGHT (kg)	DIMENSIONI, MM	ANGOLO ANGLE
		DIMENSIONS, MM	
R5SMSIN	4,25		170°

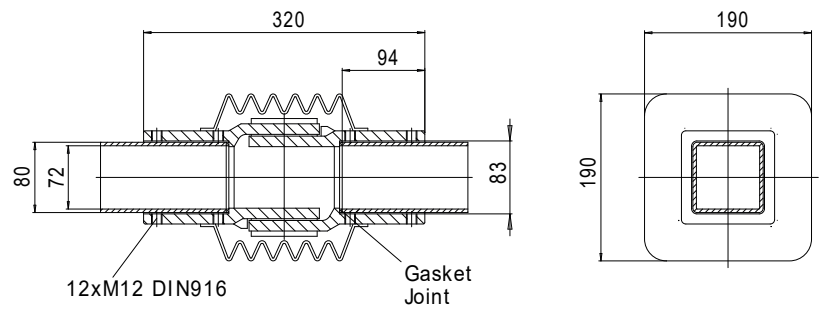

■ Sistema Medium Medium system

Torretta rotante Medium Medium Rotating turret



Per il fissaggio al tetto dell'armadio e/o a superfici orizzontali. Utilizzare in abbinamento al tubo quadrato 50x50mm (cod. R5SMSTR) o 80x80 mm (cod. R5SHSTR).

For starting from the ground and/or horizontal surfaces. To be used in combination with 50x50mm (cod. R5SMSTR) or 80x80 mm (cod. R5SHSTR) square pipe.

CODICE CODE	DIMENSIONI, MM DIMENSIONS, MM ANGOLO ANGLE
R5SMSTR	300°

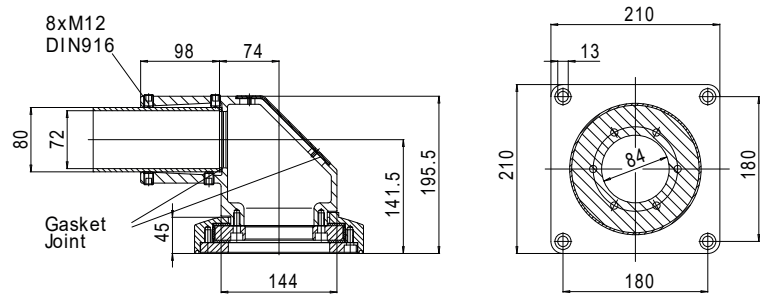

■ Sistema Medium Medium system

Adattatore angolare 90° 90 degrees angle coupling

Per collegare l'elemento orizzontale con quello verticale del sistema braccio.
Utilizzare in abbinamento ai tubi quadrati 50x50 mm.

Purposed to join horizontal and vertical elements of an arm system. To be used in combination with 50x50 mm square pipes.



CODICE CODE	DIMENSIONI, MM DIMENSIONS, MM PESO NETTO (kg) NET WEIGHT (kg)
R5SMSAF	1,35

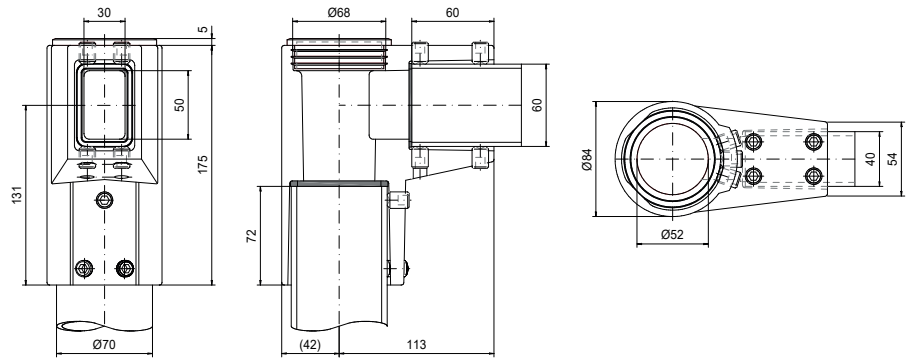

■ Sistema Medium Medium system

Tubo quadro 50x50 mm 50x50 mm square tube



Utilizzare per la composizione del sistema braccio orizzontale e verticale. In fase di installazione il tubo può essere tagliato e riutilizzato in base alle esigenze senza ulteriori lavorazioni.

Rotation angle 4mm

To be used for horizontal and vertical arm parts composition. During the installation this pipe can be cut and reemployed as required with no additional treatments.

Rotation angle 4mm

CODICE CODE	PESO NETTO (kg) NET WEIGHT (kg)	DIMENSIONI, MM	LUNGHEZZA LENGTH
		DIMENSIONS, MM	
R5SLT51	6,75		1000
R5SLT52	13,5		2000
R5SLT55	3,375		500

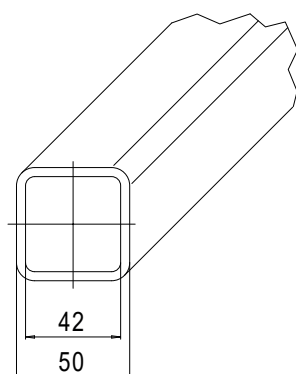

■ Sistema Medium Medium system

Snodo dritto Straight joint



Per collegare il contenitore alla parte verticale del sistema braccio. Utilizzare in abbinamento al tubo quadrato 50x50 mm.

Purposed to fasten an enclosure to the vertical part of an arm system. To be used in combination with 50x50 mm square pipe.

CODICE CODE	PESO NETTO (kg) NET WEIGHT (kg)	DIMENSIONI, MM DIMENSIONS, MM	ANGOLO ANGLE
R5MSDF	1,25		300°

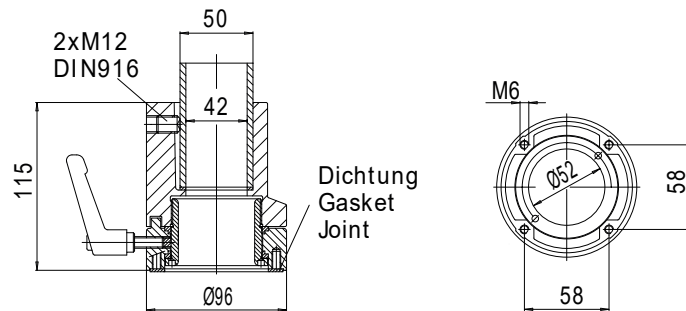

■ Sistema Medium Medium system

Snodo rotante 90° Medium 90 degrees rotating joint Medium



Permette il fissaggio del contenitore direttamente alla parte orizzontale del sistema braccio. Utilizzare in abbinamento al tubo quadrato 50x50 mm (Cod. R5SMSRF) o 80x80 mm (Cod. R5SHSRF)

Purposed to fasten an enclosure directly to the horizontal part of an arm system. To be used in combination with 50x50 mm (Cod. R5SMSRF) or 80x80 mm (Cod. R5SHSRF) square pipe.

CODICE CODE	PESO NETTO (kg) NET WEIGHT (kg)	DIMENSIONI, MM DIMENSIONS, MM	ANGOLO ANGLE
R5SMSRF	2		300°

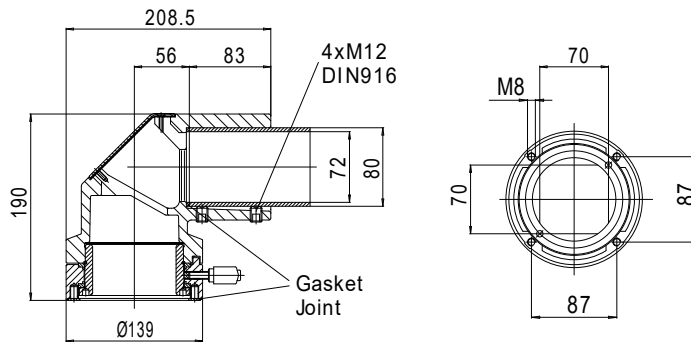

■ Sistema Medium

Medium system

Staffa rinforzo per giunto a parete sistema MEDIUM

Reinforcement bracket for MEDIUM system wall mount joint



In lamiera d'acciaio elettrozincata, spessore 20/10.

Da montare esclusivamente all'interno degli armadi in abbinamento ai profili laterali RZPDL (catalogo DKC RAMBLOCK).

Utilizzabili con armadi serie CQE e CAE.

20/10 thick galvanized sheet steel.

To be mounted exclusively in combination with RZPDL side rails (DKC RAMBLOCK Catalogue).

Suitable for CQE, and CAE enclosures.

CODICE CODE	DIMENSIONI, MM DIMENSIONS, MM DIMENSIONE (mm) DIMENSION (mm)
RZSMRSAP	55x150x150

Staffa rinforzo per torretta rotante sistema Medium

Reinforcement bracket for Medium system rotating turret



In lamiera d'acciaio elettrozincata, spessore 20/10.

Da montare esclusivamente all'interno degli armadi in abbinamento ai profili laterali RZPDL (catalogo DKC RAMBLOCK).

Utilizzabili con armadi serie CQE e CAE.

20/10 thick galvanized sheet steel.

To be mounted exclusively in combination with RZPDL side rails (DKC RAMBLOCK Catalogue).

Suitable for CQE, and CAE enclosures.

CODICE CODE	DIMENSIONI, MM DIMENSIONS, MM DIMENSIONE (mm) DIMENSION (mm)
RZSMRSTR	55x150x150

Piastra di rinforzo per contenitore per sistema MEDIUM

Reinforcement plate for enclosures purposed for MEDIUM system

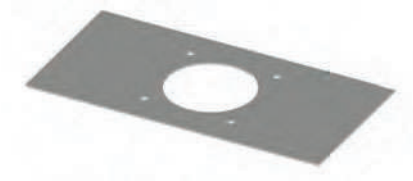

In lamiera d'acciaio elettrozincata, spessore 20/10.

Da montare esclusivamente all'interno dei contenitori serie ALUFRAME.

Utilizzabili anche per le casse serie CE, CLE, CDE (previa verifica dimensioni).

20/10 thick galvanized sheet steel.

To assemble exclusively inside ALUFRAME enclosures.

Suitable also for CE, CLE, CDE (subject to verification of enclosure dimensions).

CODICE CODE	LARGHEZZA (mm) WIDTH (mm)	DIMENSIONI, MM DIMENSIONS, MM	PROFONDITÀ (mm) DEPTH (mm)
RZSMRP	290		130

■ Sistema di sospensione a braccio portante serie HEAVY

HEAVY support arm system

Caratteristiche Specifications

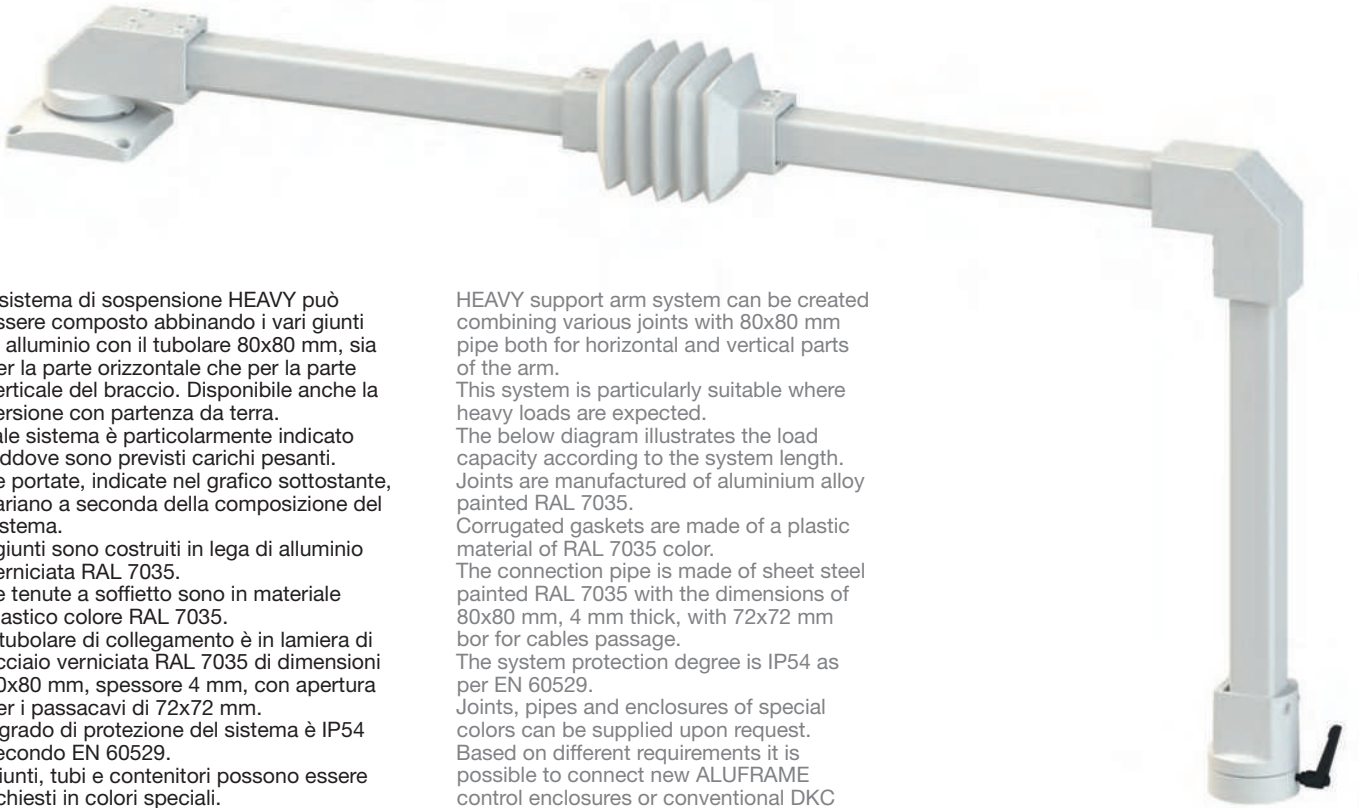

Il sistema di sospensione HEAVY può essere composto abbinando i vari giunti in alluminio con il tubolare 80x80 mm, sia per la parte orizzontale che per la parte verticale del braccio. Disponibile anche la versione con partenza da terra. Tale sistema è particolarmente indicato laddove sono previsti carichi pesanti. Le portate, indicate nel grafico sottostante, variano a seconda della composizione del sistema. I giunti sono costruiti in lega di alluminio verniciata RAL 7035. Le tenute a soffietto sono in materiale plastico colore RAL 7035. Il tubolare di collegamento è in lamiera di acciaio verniciata RAL 7035 di dimensioni 80x80 mm, spessore 4 mm, con apertura per i passacavi di 72x72 mm. Il grado di protezione del sistema è IP54 secondo EN 60529. Giunti, tubi e contenitori possono essere richiesti in colori speciali. In base alle diverse esigenze, è possibile collegare i nuovi contenitori di comando serie ALUFRAME oppure le tradizionali casse DKC serie CE, CLE e CDE.

HEAVY support arm system can be created combining various joints with 80x80 mm pipe both for horizontal and vertical parts of the arm. This system is particularly suitable where heavy loads are expected. The below diagram illustrates the load capacity according to the system length. Joints are manufactured of aluminium alloy painted RAL 7035. Corrugated gaskets are made of a plastic material of RAL 7035 color. The connection pipe is made of sheet steel painted RAL 7035 with the dimensions of 80x80 mm, 4 mm thick, with 72x72 mm bor for cables passage. The system protection degree is IP54 as per EN 60529. Joints, pipes and enclosures of special colors can be supplied upon request. Based on different requirements it is possible to connect new ALUFRAME control enclosures or conventional DKC boxes of CE, CLE and CDE series.

CARATTERISTICHE TECNICHE

- Materiale giunti: Lega di alluminio verniciata RAL 7035.
- Materiale tubi: Acciaio verniciato RAL 7035.
- Colore soffietti: RAL 7035.
- Grado di protezione: IP 54

TECHNICAL SPECIFICATIONS

- Material of joints: Aluminium alloy painted RAL 7035.
- Material of pipes: Steel painted RAL 7035.
- Corrugated gaskets color: RAL 7035.
- Protection degree: IP 54

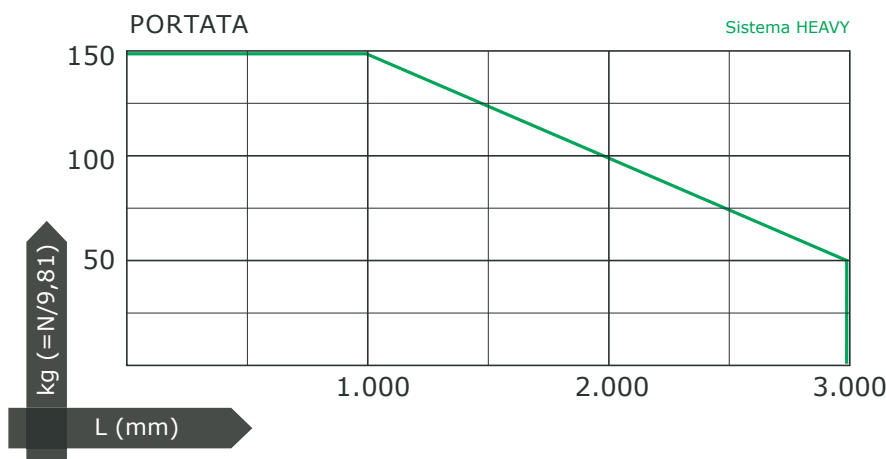

■ Sistema di sospensione a braccio portante serie HEAVY

HEAVY support arm system

Configurazioni con torretta rotante

Configuration with rotating turret

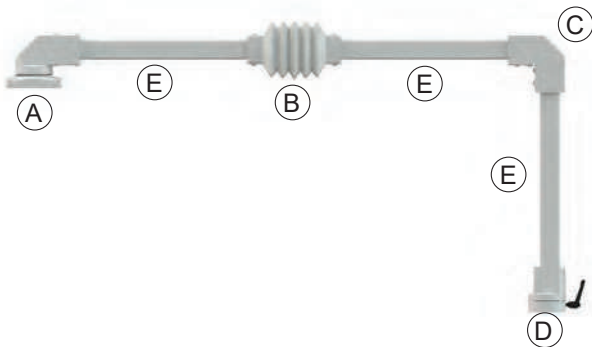

CONFIGURAZIONE 1
CONFIGURATION 1

RIF.	DESCRIZIONE DESCRIPTION	CODICE CODE	QUANTITÀ QUANTITY
A	Torretta rotante Rotating turret	R5SHSTR	1
B	Giunto intermedio Intermediate joint	R5SHSIN	1
C	Adattatore angol. Angle coupling	R5SHSAF	1
D	Snodo dritto Straight joint	R5SHSDF	1
E	Tubo quadro Square pipe	R5SLT8X*	3

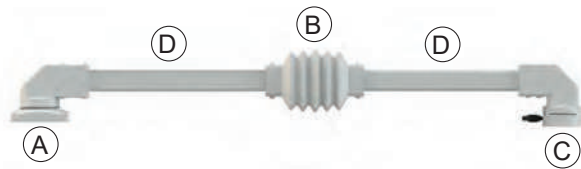

CONFIGURAZIONE 2
CONFIGURATION 2

RIF.	DESCRIZIONE DESCRIPTION	CODICE CODE	QUANTITÀ QUANTITY
A	Torretta rotante Rotating turret	R5SHSTR	1
B	Giunto intermedio Intermediate joint	R5SHSIN	1
C	Snodo rotante Rotating joint	R5SHSRF	1
D	Tubo quadro Square pipe	R5SLT8X*	2

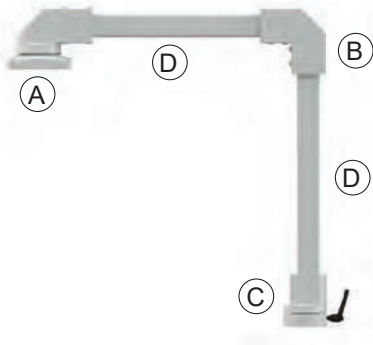

CONFIGURAZIONE 3
CONFIGURATION 3

RIF.	DESCRIZIONE DESCRIPTION	CODICE CODE	QUANTITÀ QUANTITY
A	Torretta rotante Rotating turret	R5SHSTR	1
B	Adattatore angol. Angle coupling	R5SHSAF	1
C	Snodo dritto Straight joint	R5SHSDF	1
D	Tubo quadro Square pipe	R5SLT8X*	2

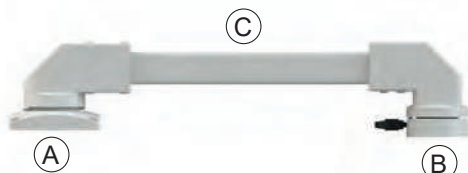

CONFIGURAZIONE 4
CONFIGURATION 4

RIF.	DESCRIZIONE DESCRIPTION	CODICE CODE	QUANTITÀ QUANTITY
A	Torretta rotante Rotating turret	R5SHSTR	1
B	Snodo rotante Rotating joint	R5SHSRF	1
C	Tubo quadro Square pipe	R5SLT8X*	1

Sostituire X con il numero relativo alla lunghezza del tubo necessario: 5 per il tubo da 500 mm, 1 per il tubo da 1000 mm, 2 per il tubo da 2000 mm.
X is to be substituted by a number relative to the required pipe length: 5 for 500 mm pipe, 1 for 1000 mm pipe, 2 for 2000 mm pipe.

■ Sistema di sospensione a braccio portante serie HEAVY

HEAVY support arm system

Configurazioni con giunto a parete Configuration with wall mount joint

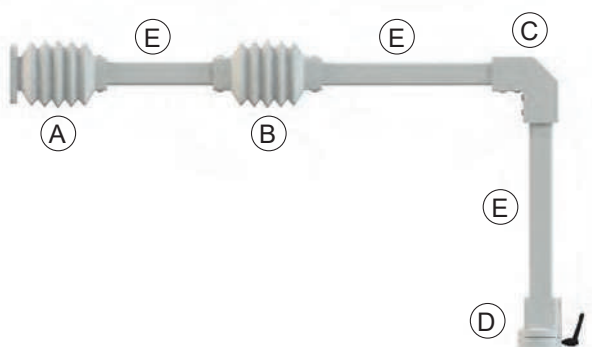

CONFIGURAZIONE 5
CONFIGURATION 5

RIF.	DESCRIZIONE DESCRIPTION	CODICE CODE	QUANTITÀ QUANTITY
A	Giunto a parete Wall mount joint	R5SHSAP	1
B	Giunto intermedio Intermediate joint	R5SHSIN	1
C	Adattatore angol. Angle coupling	R5SHSAF	1
D	Snodo dritto Straight joint	R5SHSDF	1
E	Tubo quadro Square pipe	R5SLT8X*	3

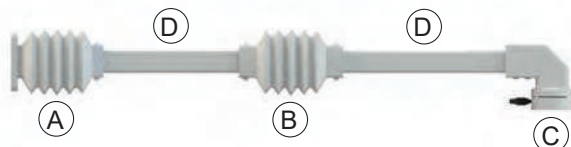

CONFIGURAZIONE 6
CONFIGURATION 6

RIF.	DESCRIZIONE DESCRIPTION	CODICE CODE	QUANTITÀ QUANTITY
A	Giunto a parete Wall mount joint	R5SHSAP	1
B	Giunto intermedio Intermediate joint	R5SHSIN	1
C	Snodo rotante Rotating joint	R5SHSRF	1
D	Tubo quadro Square pipe	R5SLT8X*	2

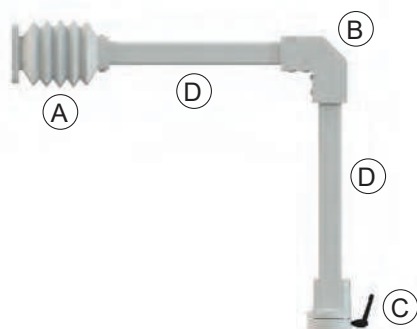

CONFIGURAZIONE 7
CONFIGURATION 7

RIF.	DESCRIZIONE DESCRIPTION	CODICE CODE	QUANTITÀ QUANTITY
A	Giunto a parete Wall mount joint	R5SHSAP	1
B	Adattatore angol. Angle coupling	R5SHSAF	1
C	Snodo dritto Straight joint	R5SHSDF	1
D	Tubo quadro Square pipe	R5SLT8X*	2

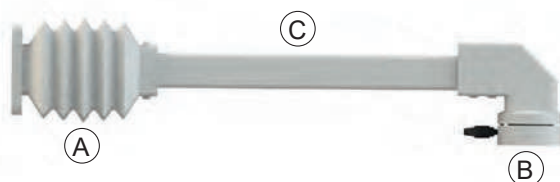

CONFIGURAZIONE 8
CONFIGURATION 8

RIF.	DESCRIZIONE DESCRIPTION	CODICE CODE	QUANTITÀ QUANTITY
A	Giunto a parete Wall mount joint	R5SHSAP	1
B	Snodo rotante Rotating joint	R5SHSRF	1
C	Tubo quadro Square pipe	R5SLT8X*	1

Sostituire X con il numero relativo alla lunghezza del tubo necessario: 5 per il tubo da 500 mm, 1 per il tubo da 1000 mm, 2 per il tubo da 2000 mm.
X is to be substituted by a number relative to the required pipe length: 5 for 500 mm pipe, 1 for 1000 mm pipe, 2 for 2000 mm pipe.

■ Sistema di sospensione a braccio portante serie HEAVY HEAVY support arm system

Configurazioni con partenza da terra Configuration with starts from ground

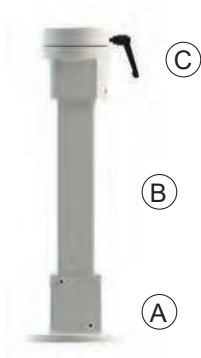

CONFIGURAZIONE 1
CONFIGURATION 1

RIF.	DESCRIZIONE DESCRIPTION	CODICE CODE	QUANTITÀ QUANTITY
A	Giunto da terra Ground joint	R5SHGPT80	1
B	Tubo quadro Square pipe	R5SLT8X*	1
C	Snodo dritto Straight joint	R5SHSDF	1

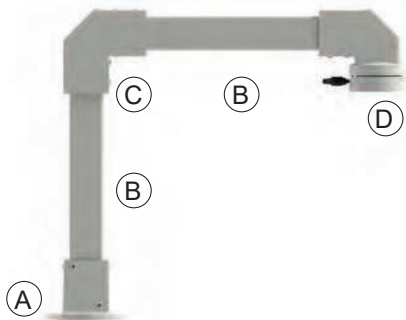

CONFIGURAZIONE 2
CONFIGURATION 2

RIF.	DESCRIZIONE DESCRIPTION	CODICE CODE	QUANTITÀ QUANTITY
A	Giunto da terra Ground joint	R5SHGPT80	1
B	Tubo quadro Square pipe	R5SLT8X*	2
C	Adattatore angol. Angle coupling	R5SHSAF	1
D	Snodo rotante Rotating joint	R5SHSRF	1

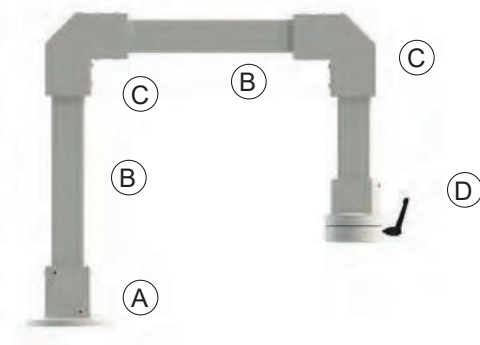

CONFIGURAZIONE 3
CONFIGURATION 3

RIF.	DESCRIZIONE DESCRIPTION	CODICE CODE	QUANTITÀ QUANTITY
A	Giunto da terra Ground joint	R5SHGPT80	1
B	Tubo quadro Square pipe	R5SLT8X*	2
C	Adattatore angol. Angle coupling	R5SHSAF	2
D	Snodo dritto Straight joint	R5SHSDF	1

Sostituire X con il numero relativo alla lunghezza del tubo necessario: 5 per il tubo da 500 mm, 1 per il tubo da 1000 mm, 2 per il tubo da 2000 mm.
X is to be substituted by a number relative to the required pipe length: 5 for 500 mm pipe, 1 for 1000 mm pipe, 2 for 2000 mm pipe.

■ Sistema Heavy Heavy system

Giunto con partenza da terra Joint with starts from ground



Per la partenza da terra e/o da superfici orizzontali. Utilizzare in abbinamento al tubo quadrato 80x80 mm.

For starting from the ground and/or horizontal surfaces. Use in conjunction with square tube 80x80 mm

CODICE CODE	DIMENSIONI, MM DIMENSIONS, MM PESO NETTO (kg) NET WEIGHT (kg)
R5SHGPT80	7

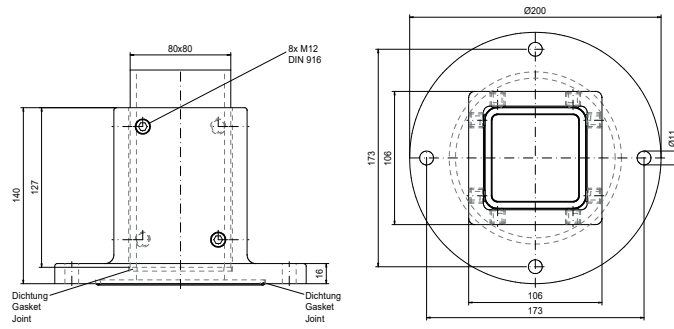

■ Sistema Heavy Heavy system

Giunto a parete Wall mount joint

Per il fissaggio alla parete dell'armadio e/o a superfici verticali. Utilizzare in abbinamento al tubo quadrato 50x50 mm.

Purposed for fastening to an enclosure wall and/or horizontal surfaces. To be used in combination with a 50x50 mm square pipe.



CODICE CODE	DIMENSIONI, MM DIMENSIONS, MM
	ANGOLO ANGLE
R5SHSAP	170°

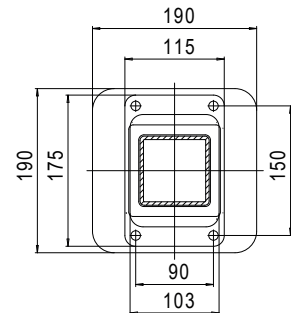
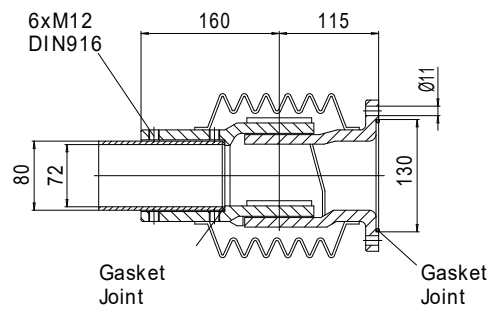

■ Sistema Heavy Heavy system

Giunto intermedio Intermediate joint

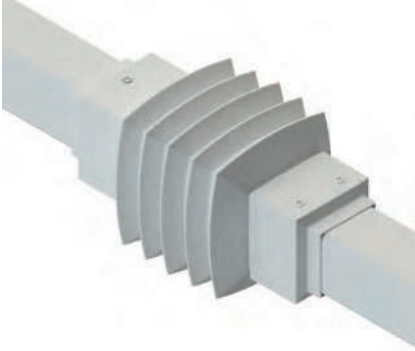

Permette di accoppiare più elementi orizzontali del sistema braccio, consentendone la rotazione. Utilizzare in abbinamento ai tubi quadrati 50x50 mm.

Allows coupling several horizontal elements of an arm system providing its rotation. To be used in combination with 50x50 mm square pipes.

CODICE CODE	DIMENSIONI, MM DIMENSIONS, MM
	ANGOLO ANGLE
R5SHSIN	170°

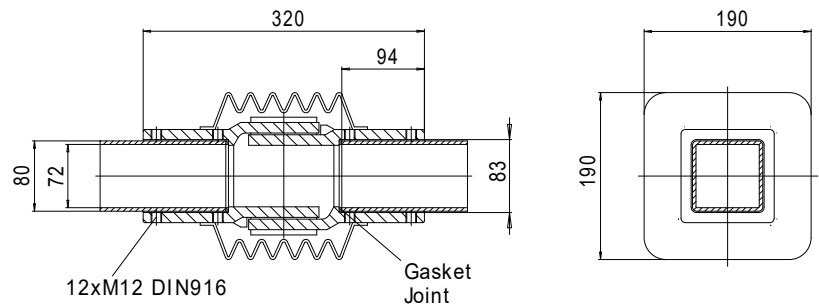

■ Sistema Heavy

Heavy system

Torretta rotante Heavy

Rotating turret



Per il fissaggio al tetto dell'armadio e/o a superfici orizzontali. Utilizzare in abbinamento al tubo quadrato 50x50mm (cod. R5SMSTR) o 80x80 mm (cod. R5SHSTR).

For starting from the ground and/or horizontal surfaces. To be used in combination with 50x50mm (cod. R5SMSTR) or 80x80 mm (cod. R5SHSTR) square pipe.

CODICE CODE	DIMENSIONI, MM DIMENSIONS, MM ANGOLO ANGLE
R5SHSTR	300°

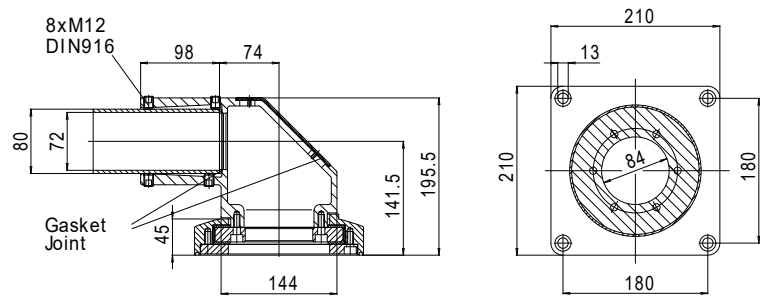

■ Sistema Heavy Heavy system

Adattatore angolare 90° 90 degrees angle coupling



Per collegare l'elemento orizzontale con quello verticale del sistema braccio. Utilizzare in abbinamento ai tubi quadrati 50x50 mm.

Purposed to join horizontal and vertical elements of an arm system. To be used in combination with 50x50 mm square pipes.

CODICE CODE	DIMENSIONI, MM DIMENSIONS, MM PESO NETTO (kg) NET WEIGHT (kg)
R5SHSAF	2,4

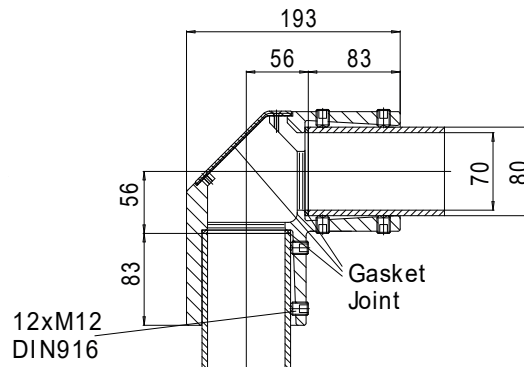

■ Sistema Heavy Heavy system

Snodo rotante dritto Straight joint

Per collegare il contenitore alla parte verticale del sistema braccio. Utilizzare in abbinamento al tubo quadrato 80x80 mm.

Purposed to fasten an enclosure to the vertical part of an arm system. To be used in combination with 80x80 mm square pipe.



CODICE CODE	DIMENSIONI, MM DIMENSIONS, MM
	ANGOLO ANGLE
R5SHSDF	300°

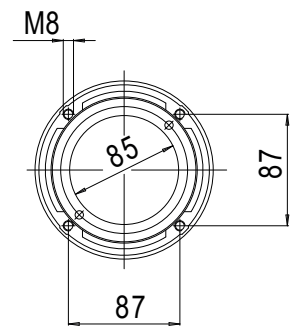
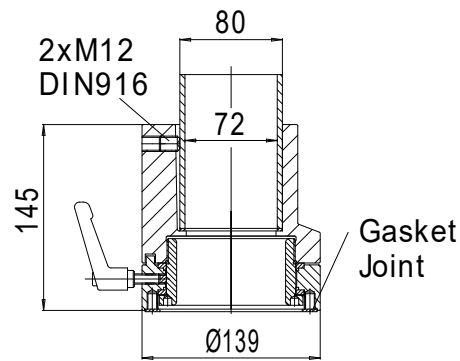

■ Sistema Heavy Heavy system

Snodo rotante 90° 90 degrees rotating joint



Permette il fissaggio del contenitore direttamente alla parte orizzontale del sistema braccio. Utilizzare in abbinamento al tubo quadrato 50x50 mm (Cod. R5SMSRF) o 80x80 mm (Cod. R5SHSRF)

Purposed to fasten an enclosure directly to the horizontal part of an arm system. To be used in combination with 50x50 mm (Cod. R5SMSRF) or 80x80 mm (Cod. R5SHSRF) square pipe.

CODICE CODE	DIMENSIONI, MM DIMENSIONS, MM
	ANGOLO ANGLE
R5SHSRF	300°

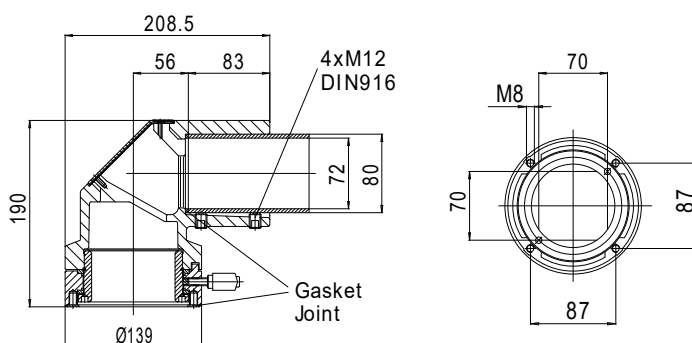

Tubo quadro 80 mm 80x80 mm square tube



Utilizzare per la composizione del sistema braccio orizzontale e verticale. In fase di installazione il tubo può essere tagliato e riutilizzato in base alle esigenze senza ulteriori lavorazioni.

To be used for horizontal and vertical arm parts composition. During the installation this pipe can be cut and reemployed as required with no additional treatments.

CODICE CODE	LARGHEZZA (mm) WIDTH (mm)	PESO NETTO (kg) NET WEIGHT (kg)
R5SLT81	-	10,48
R5SLT85	500	5,24
R5SLT82	2000	20,86

■ Sistema Heavy

Heavy system

Staffa rinforzo per torretta rotante sistema HEAVY

Reinforcement bracket for HEAVY system rotating turret joint

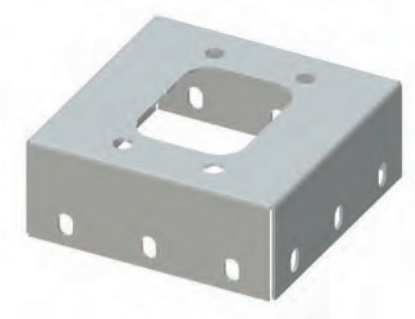

In lamiera d'acciaio elettrozincata, spessore 20/10.

Da montare esclusivamente all'interno degli armadi in abbinamento ai profili laterali RZPDL (catalogo DKC RAMBLOCK).

Utilizzabili con armadi serie CQE e CAE.

20/10 thick galvanized sheet steel.

To be mounted exclusively in combination with RZPDL side rails (DKC RAMBLOCK Catalogue).

Suitable for CQE, and CAE enclosures.

CODICE CODE	DIMENSIONI, MM DIMENSIONS, MM DIMENSIONE (mm) DIMENSION (mm)
RZSHRSTR	55X250X250

Staffa rinforzo per giunto a parete sistema HEAVY

Reinforcement bracket for HEAVY system wall mount joint

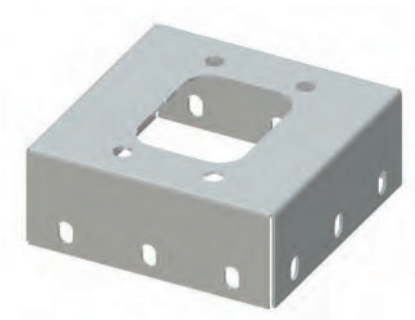

In lamiera d'acciaio elettrozincata, spessore 20/10.

Da montare esclusivamente all'interno degli armadi in abbinamento ai profili laterali RZPDL (catalogo DKC RAMBLOCK).

Utilizzabili con armadi serie CQE e CAE.

20/10 thick galvanized sheet steel.

To be mounted exclusively in combination with RZPDL side rails (DKC RAMBLOCK Catalogue).

Suitable for CQE, and CAE enclosures.

CODICE CODE	DIMENSIONI, MM DIMENSIONS, MM DIMENSIONE (mm) DIMENSION (mm)
RZSHRSAP	55X250X250

Piastra di rinforzo per contenitore per sistema HEAVY

Reinforcement plate for enclosures purposed for HEAVY system

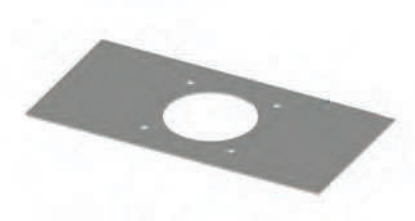

In lamiera d'acciaio elettrozincata, spessore 20/10.

Da montare esclusivamente all'interno dei contenitori serie ALUFRAME.

Utilizzabili anche per le casse serie CE, CLE, CDE (previa verifica dimensioni).

20/10 thick galvanized sheet steel.

To assemble exclusively inside ALUFRAME enclosures.

Suitable also for CE, CLE, CDE (subject to verification of enclosure dimensions).

CODICE CODE	LARGHEZZA (mm) WIDTH (mm)	DIMENSIONI, MM DIMENSIONS, MM	PROFONDITÀ (mm) DEPTH (mm)
RZSHPR	290		130

■ Contenitori Aluframe

Aluframe control enclosures

Contenitori di comando serie ALUFRAME

Front panels for ALUFRAME control enclosures



I contenitori di comando serie ALUFRAME nascono come completamento dei sistemi braccio portante DKC.

Il corpo del contenitore è costruito in lamiera di acciaio verniciata RAL 7035 bucciato.

La porta frontale, con sistema di chiusura sul lato del contenitore, è incernierata con apertura a 180°. Tale porta è costituita da una cornice in alluminio verniciata RAL 7035 e da un pannello frontale in alluminio preanodizzato, fissabile alla cornice stessa mediante viti automaschianti.

Il pannello frontale è di spessore 25/10 e può essere personalizzato in base alle esigenze del cliente.

Possibilità di allestimento interno con piastra di montaggio in lamiera zincata (non inclusa nella fornitura del contenitore ALUFRAME).

The ALUFRAME control enclosures have been conceived to complete the support arm systems of DKC.

The enclosure casing is manufactured of sheet steel painted textured RAL 7035.

The front door, with a locking system on the enclosure side, is hinged and has the opening angle of 180°.

The door is composed by a frame of aluminium painted RAL 7035 and a front panel of preanodized aluminium, attachable to the frame by means of selftapping screws.

The front panel is 25/10 thick and is customizable according to the clients' requirements.

Internal arrangement can be performed using mounting panels of galvanized steel (not included to the delivery set of ALUFRAME enclosures).

H 300

CODICE CODE	LARGHEZZA (mm) WIDTH (mm)	PROFONDITÀ (mm) DEPTH (mm)	DIMENSIONI, MM DIMENSIONS, MM		SPESSORE THICKNESS
			ALTEZZA VISTA UTILE USEFUL VIEW HEIGHT	LARGHEZZA VISTA UTILE USEFUL VIEW WIDTH	
R5AF0331	300	150	254	254	1,2
R5AF0431	400			354	

H 400

CODICE CODE	LARGHEZZA (mm) WIDTH (mm)	PROFONDITÀ (mm) DEPTH (mm)	DIMENSIONI, MM DIMENSIONS, MM		SPESSORE THICKNESS
			ALTEZZA VISTA UTILE USEFUL VIEW HEIGHT	LARGHEZZA VISTA UTILE USEFUL VIEW WIDTH	
R5AF0341	300	150	354	254	1,2
R5AF0441	400			354	
R5AF0541	500			454	

H 500

CODICE CODE	LARGHEZZA (mm) WIDTH (mm)	PROFONDITÀ (mm) DEPTH (mm)	DIMENSIONI, MM DIMENSIONS, MM		SPESSORE THICKNESS
			ALTEZZA VISTA UTILE USEFUL VIEW HEIGHT	LARGHEZZA VISTA UTILE USEFUL VIEW WIDTH	
R5AF0451	400	150	454	354	1,5
R5AF0551	500			454	

■ Contenitori Aluframe

Aluframe control enclosures

Piastra di montaggio per contenitori di comando serie ALUFRAME

Mounting panel for ALUFRAME control enclosures



In lamiera d'acciaio zincata, spessore 20/10. Accessori di fissaggio inclusi nella fornitura.
Opzionale. Non inclusa nel contenitore serie ALUFRAME.

Manufactured of 20/10 thick galvanized sheet steel.
Fasteners included to the delivery set.
Option. Not included to the delivery set of ALUFRAME enclosures.

H 300

CODICE CODE	DIMENSIONI, MM DIMENSIONS, MM LARGHEZZA (mm) WIDTH (mm)
RZPM33	300
RZPM34	400

H 400

CODICE CODE	DIMENSIONI, MM DIMENSIONS, MM LARGHEZZA (mm) WIDTH (mm)
RZPM43	300
RZPM44	400
RZPM45	500

H 500

CODICE CODE	DIMENSIONI, MM DIMENSIONS, MM LARGHEZZA (mm) WIDTH (mm)
RZPM54	400
RZPM55	500

Maniglia Rack

Universal handle for rack frames



Maniglia in poliammide di colore nero da installare sui contenitori ALUFRAME per facilitare la movimentazione degli stessi.
Comprensiva di viteria di fissaggio.

Handle black color polyamide to be installed on ALUFRAME containers to facilitate handling of the same.
Including fixing screws.

CODICE CODE	FINITURA FINISHING	DIMENSIONI, MM DIMENSIONS, MM	CONFEZIONI/PZ PACK/PCS
RPA25	Poliammide colore nero black color	Polyamide	1

■ Contenitori Aluframe

Aluframe control enclosures

Pannelli frontali per contenitori di comando serie ALUFRAME (accessori di ricambio)

Replacement front plate for ALUFRAME control cabinet

Pannello frontale in alluminio
preanodizzato, spessore 25/10.

Front panel of 25/10 thick preanodized
aluminium.



H 300

CODICE CODE	DIMENSIONI, MM DIMENSIONS, MM LARGHEZZA (mm) WIDTH (mm)
RZPF33	300
RZPF43	400

H 400

CODICE CODE	DIMENSIONI, MM DIMENSIONS, MM LARGHEZZA (mm) WIDTH (mm)
RZPF34	300
RZPF44	400
RZPF54	500

H 500

CODICE CODE	DIMENSIONI, MM DIMENSIONS, MM LARGHEZZA (mm) WIDTH (mm)
RZPF45	400
RZPF55	500



Approfondimenti
Approfondimenti

■ Approfondimenti Approfondimenti

Prodotti personalizzati Customized products



DKC offre ai suoi clienti la possibilità di fornire prodotti personalizzati in base alle richieste.

Per prodotti personalizzati DKC definisce tutte le esecuzioni che partono da prodotti standard, da cui differiscono per specifiche esigenze in termini di:

- Foratura sul corpo del prodotto
- Verniciatura con colori fuori standard
- Montaggio nelle strutture di accessori acquistati e normalmente forniti sciolti
- Assemblaggio di più strutture in batteria, in base alla configurazione richiesta dal cliente

DKC offers its customers the opportunity to provide customized products based on requests.

For customized products DKC defines all the executions that start from standard products, from which they differ for specific needs in terms of:

- Drilling on the product body
- Painting with non-standard colors
- Assembly in the structures of accessories purchased and normally supplied loose
- Assembly of multiple battery structures, based on the configuration requested by the customer



Prodotti speciali Special products



Oltre ai prodotti personalizzati, DKC è in grado di sviluppare soluzioni customizzate in grado di soddisfare le esigenze del cliente in termini di:

- Prodotti con dimensioni fuori standard
- Particolari che contemplano lavorazioni su richiesta
- Soluzioni studiate ad hoc su richiesta

Tutto questo ventaglio di possibilità ricade per DKC nei Prodotti Speciali.

In addition to customized products, DKC is able to develop customized solutions that can meet customer needs in terms of:

- Products with non-standard dimensions
- Details that include processing on request
- Solutions designed ad hoc on request

All this range of possibilities falls for DKC in the Special Products.



■ Approfondimenti

Approfondimenti

Sovratemperatura (Rif. Norma CEI EN 61439-1) Overheating (Ref. standard CEI EN 61439-1)

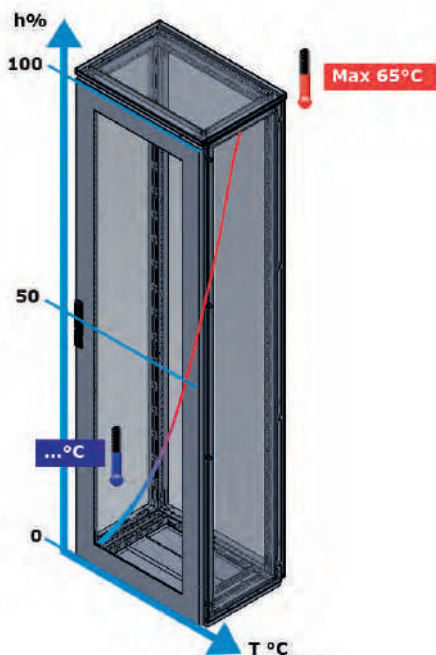

Nelle tabelle che seguono sono riportati i valori di dissipazione termica riferiti alle dimensioni dei nostri armadi e a come vengono installati. I dati di potenza dissipabile (misurata in Watt) sono in funzione della sovratemperatura che può essere ammessa all'interno del quadro nella zona superiore e deve essere confrontata con la somma delle potenze dissipate dai diversi componenti installati all'interno del quadro.

Con l'entrata in vigore della nuova norma quadri CEI EN 61439-1, il calcolo della sovratemperatura può essere effettuato con prove di tipo, regole di progetto, calcoli, senza alcun limite alla potenza o alla corrente del quadro elettrico.

Utilizzo delle tabelle di potenza dissipabile

Il valore di potenza dissipabile da un armadio è in funzione sia della temperatura massima (TMAX) che delle sovratemperature ammissibili (Norma CEI EN 61439-1).

Uno dei metodi di calcolo della dissipazione termica (verifica mediante calcolo), è dato dalla CEI 17-43.

Esempio

L'esempio utilizzato è applicabile a tutte le temperature riportate nelle tabelle sottostanti.

Consideriamo una temperatura ambiente di 30°C, la potenza dissipabile va letta in corrispondenza della massima sovratemperatura (ΔT) ammissibile, che è pari a 30°C, questo se è accettabile una temperatura nella parte superiore del quadro pari a 60°C.

The tables below contain heat dissipation values referred to the dimensions of our enclosures and their installation type. The data on power that can be dissipated (measured in Watt) depends on the overheating allowable inside the enclosure in the upper part, and is to be compared with the sum of power values dissipated by various components installed inside the electrical assembly.

Having come into force the new standard CEI EN 61439-1 for electrical assemblies, the overheating calculations may be effectuated with type tests, design rules, calculations, with no limit of power or current of the electrical assembly.

Use of power dissipation tables

The value of power that can be dissipated depends both on the maximum temperature (TMAX) and on the allowable overheating (Standard CEI EN 61439-1). One of the methods of heat dissipation calculation (verification by means of calculations) is specified by CEI 17-43.

Example

The example used is applicable to all the temperature values given in the tables below. Let us consider an environment temperature of 30°C, the power that can be dissipated is determined in correspondence with the maximum allowable overheating (ΔT), which is equal to 30°C, at the condition that a temperature of 60°C is allowable in the upper part of the enclosure.

Approfondimenti

Approfondimenti

Dissipazione casse

Boxes dissipation

H200

DIMENSIONE DIMENSIONS		DELTA T (C°) POTENZA DISSIPABILE (W) POWER DISSIPATION CAPABILITY (W)															
		LIBERO SU TUTTI I LATI FREE-STANDING				COPERTO SU RETRO WALL-PROP				COPERTO SU RETRO E SU UN LATO				INCASSATA			
L	P	10°	20°	30°	40°	10°	20°	30°	40°	10°	20°	30°	40°	10°	20°	30°	40°
300	150	12	25	37	50	11	22	33	44	10	21	31	42	8	16	24	32

H300

DIMENSIONE DIMENSIONS		DELTA T (C°) POTENZA DISSIPABILE (W) POWER DISSIPATION CAPABILITY (W)															
		LIBERO SU TUTTI I LATI FREE-STANDING				COPERTO SU RETRO WALL-PROP				COPERTO SU RETRO E SU UN LATO				INCASSATA			
L	P	10°	20°	30°	40°	10°	20°	30°	40°	10°	20°	30°	40°	10°	20°	30°	40°
250	150	15	30	44	59	13	26	39	52	12	24	36	49	10	19	29	39
300	150	17	34	50	67	15	30	45	59	14	28	42	55	11	22	33	45
400	150	21	42	63	84	18	37	55	73	17	35	52	69	14	28	42	56
400	200	24	48	72	96	21	43	64	85	20	40	60	80	16	31	47	62

H400

DIMENSIONE DIMENSIONS		DELTA T (C°) POTENZA DISSIPABILE (W) POWER DISSIPATION CAPABILITY (W)															
		LIBERO SU TUTTI I LATI FREE-STANDING				COPERTO SU RETRO WALL-PROP				COPERTO SU RETRO E SU UN LATO				INCASSATA			
L	P	10°	20°	30°	40°	10°	20°	30°	40°	10°	20°	30°	40°	10°	20°	30°	40°
300	150	21	43	64	85	19	37	56	75	17	35	52	69	14	29	43	57
300	200	24	49	73	98	22	44	65	87	20	40	60	80	16	32	48	64
400	200	30	60	90	120	26	53	79	106	25	49	74	99	20	40	59	79
400	300	37	74	111	148	33	67	100	134	31	62	92	123	24	47	71	94
400	400	44	88	132	176	40	81	121	162	37	74	111	148	27	55	82	109
600	200	41	82	123	164	36	71	107	143	34	68	102	136	28	55	83	110

H500

DIMENSIONE DIMENSIONS		DELTA T (C°) POTENZA DISSIPABILE (W) POWER DISSIPATION CAPABILITY (W)															
		LIBERO SU TUTTI I LATI FREE-STANDING				COPERTO SU RETRO WALL-PROP				COPERTO SU RETRO E SU UN LATO				INCASSATA			
L	P	10°	20°	30°	40°	10°	20°	30°	40°	10°	20°	30°	40°	10°	20°	30°	40°
300	150	26	51	77	103	22	45	67	90	21	42	62	83	21	42	62	83
300	200	29	59	88	117	26	52	78	104	24	48	72	95	24	48	72	95
400	150	32	64	96	127	27	55	82	110	26	52	77	103	26	52	77	103
400	200	36	72	108	143	31	63	94	126	29	59	88	117	29	59	88	117
400	250	40	80	120	160	35	71	106	142	33	65	98	131	33	65	98	131
500	200	42	85	127	169	37	74	111	147	35	69	104	139	35	69	104	139
500	300	51	102	153	205	46	91	137	183	42	85	127	169	42	85	127	169
600	200	49	98	147	195	42	84	127	169	40	80	120	160	40	80	120	160
600	300	58	117	175	234	52	104	155	207	49	97	146	194	49	97	146	194

H600

DIMENSIONE DIMENSIONS		DELTA T (C°) POTENZA DISSIPABILE (W) POWER DISSIPATION CAPABILITY (W)															
		LIBERO SU TUTTI I LATI FREE-STANDING				COPERTO SU RETRO WALL-PROP				COPERTO SU RETRO E SU UN LATO				INCASSATA			
L	P	10°	20°	30°	40°	10°	20°	30°	40°	10°	20°	30°	40°	10°	20°	30°	40°
400	150	37	75	112	149	32	64	96	128	30	60	90	120	26	51	77	103
400	200	42	84	125	167	37	73	110	146	34	68	102	136	28	56	84	113
400	300	51	102	152	203	46	91	137	182	42	83	125	166	33	66	99	132
400	400	60	120	180	239	55	109	164	218	49	99	148	197	38	76	114	151
400	250	46	93	139	185	41	82	123	164	38	75	113	151	31	61	92	122
500	200	49	99	148	197	43	85	128	171	40	80	120	160	34	67	101	134
500	250	54	108	163	217	48	95	143	190	44	89	133	177	36	72	108	145
600	200	57	114	170	227	49	98	147	195	46	92	139	185	39	78	117	156
600	300	67	135	202	269	59	119	178	238	55	111	166	222	45	89	134	178
600	400	78	156	234	312	70	140	210	280	65	129	194	259	50	100	150	201
600	250	62	124	186	248	54	108	162	216	51	102	152	203	42	83	125	167

Approfondimenti

Approfondimenti

Dissipazione casse

Boxes dissipation

H700

DIMENSIONE DIMENSIONS		DELTA T (C°) POTENZA DISSIPABILE (W) POWER DISSIPATION CAPABILITY (W)															
		LIBERO SU TUTTI I LATI FREE-STANDING				COPERTO SU RETRO WALL-PROP				COPERTO SU RETRO E SU UN LATO				INCASSATA			
L	P	10°	20°	30°	40°	10°	20°	30°	40°	10°	20°	30°	40°	10°	20°	30°	40°
500	200	56	112	169	225	49	97	146	194	45	91	136	182	39	77	116	154
500	250	62	123	185	246	54	108	162	216	50	100	150	200	41	83	124	166

H800

DIMENSIONE DIMENSIONS		DELTA T (C°) POTENZA DISSIPABILE (W) POWER DISSIPATION CAPABILITY (W)															
		LIBERO SU TUTTI I LATI FREE-STANDING				COPERTO SU RETRO WALL-PROP				COPERTO SU RETRO E SU UN LATO				INCASSATA			
L	P	10°	20°	30°	40°	10°	20°	30°	40°	10°	20°	30°	40°	10°	20°	30°	40°
600	200	73	145	218	290	62	124	186	248	59	117	176	234	50	101	151	202
600	300	85	170	255	341	75	149	224	298	69	139	208	277	57	114	171	228
600	400	98	195	293	391	87	174	261	348	80	160	240	320	64	128	191	255
600	250	79	158	237	315	68	137	205	273	64	128	192	256	54	107	161	215
800	200	92	183	275	366	77	155	232	310	74	148	222	296	64	128	193	257
800	300	106	211	317	422	92	183	275	366	86	172	259	345	72	143	215	287
800	400	120	239	359	479	106	211	317	422	99	197	296	394	79	158	238	317

H1000

DIMENSIONE DIMENSIONS		DELTA T (C°) POTENZA DISSIPABILE (W) POWER DISSIPATION CAPABILITY (W)															
		LIBERO SU TUTTI I LATI FREE-STANDING				COPERTO SU RETRO WALL-PROP				COPERTO SU RETRO E SU UN LATO				INCASSATA			
L	P	10°	20°	30°	40°	10°	20°	30°	40°	10°	20°	30°	40°	10°	20°	30°	40°
600	300	103	206	309	412	90	180	269	359	83	166	249	333	70	139	209	279
600	400	117	235	352	470	104	209	313	417	95	191	286	382	77	155	232	310
600	250	96	191	287	383	83	165	248	330	77	154	231	308	66	131	197	263
800	200	111	223	334	445	94	187	281	375	89	179	268	357	79	158	236	315
800	300	127	255	382	510	110	220	329	439	103	206	310	413	87	175	262	349
800	400	143	287	430	574	126	252	378	503	117	234	351	468	96	192	288	384
800	250	119	239	358	477	102	204	305	407	96	193	289	385	83	166	249	332

H1200

DIMENSIONE DIMENSIONS		DELTA T (C°) POTENZA DISSIPABILE (W) POWER DISSIPATION CAPABILITY (W)															
		LIBERO SU TUTTI I LATI FREE-STANDING				COPERTO SU RETRO WALL-PROP				COPERTO SU RETRO E SU UN LATO				INCASSATA			
L	P	10°	20°	30°	40°	10°	20°	30°	40°	10°	20°	30°	40°	10°	20°	30°	40°
600	300	121	242	362	483	105	210	315	420	97	194	291	388	82	164	247	329
600	400	137	275	412	549	121	243	364	486	111	222	333	444	91	182	273	364
800	300	149	298	447	597	128	256	384	512	120	240	360	480	103	206	309	412
800	400	167	334	502	669	146	292	438	584	136	271	407	542	113	225	338	451

H1400

DIMENSIONE DIMENSIONS		DELTA T (C°) POTENZA DISSIPABILE (W) POWER DISSIPATION CAPABILITY (W)															
		LIBERO SU TUTTI I LATI FREE-STANDING				COPERTO SU RETRO WALL-PROP				COPERTO SU RETRO E SU UN LATO				INCASSATA			
L	P	10°	20°	30°	40°	10°	20°	30°	40°	10°	20°	30°	40°	10°	20°	30°	40°
600	300	139	277	416	554	120	240	360	480	111	222	333	444	95	189	284	379
800	300	171	342	513	684	146	293	439	585	137	274	411	548	119	237	356	474

Approfondimenti

Approfondimenti

Dissipazione armadi

Enclosures dissipation

H1000

DIMENSIONE DIMENSIONS		LIBERO SU TUTTI I LATI FREE-STANDING				DELTA T (C°) POTENZA DISSIPABILE (W) POWER DISSIPATION CAPABILITY (W)				COPERTO SU RETRO E SU UN LATO			
		10°	20°	30°	40°	COPERTO SU RETRO WALL-PROP				10°	20°	30°	40°
L	P					10°	20°	30°	40°	10°	20°	30°	40°
600	300	103	206	309	412	90	180	269	359	83	166	249	333
600	400	117	235	352	470	104	209	313	417	95	191	286	382
800	300	127	255	382	510	110	220	329	439	103	206	310	413
800	400	143	287	430	574	126	252	378	503	117	234	351	468
1000	300	152	304	455	607	130	260	389	519	123	246	370	493
1000	400	169	339	508	678	147	295	442	590	139	277	416	554

H1200

DIMENSIONE DIMENSIONS		LIBERO SU TUTTI I LATI FREE-STANDING				DELTA T (C°) POTENZA DISSIPABILE (W) POWER DISSIPATION CAPABILITY (W)				COPERTO SU RETRO E SU UN LATO			
		10°	20°	30°	40°	COPERTO SU RETRO WALL-PROP				10°	20°	30°	40°
L	P					10°	20°	30°	40°	10°	20°	30°	40°
400	400	107	215	322	429	97	194	290	387	86	172	259	345
400	500	122	245	367	489	112	224	335	447	99	197	296	394
400	600	137	275	412	549	127	253	380	507	111	222	333	444
600	400	137	275	412	549	121	243	364	486	111	222	333	444
600	500	154	308	461	615	138	276	414	552	125	249	374	499
600	600	170	341	511	681	154	309	463	618	139	277	416	554
800	400	167	334	502	669	146	292	438	584	136	271	407	542
800	500	185	370	556	741	164	328	492	656	151	302	453	604
800	600	203	407	610	813	182	364	546	729	166	333	499	665
1000	400	197	394	591	788	171	341	512	683	160	320	480	641
1000	500	217	433	650	867	190	381	571	761	177	354	531	708
1000	600	236	473	709	945	210	420	630	840	194	388	582	776
1200	400	227	454	681	908	195	391	586	781	185	370	554	739
1200	500	248	496	744	993	216	433	649	866	203	407	610	813
1200	600	269	539	808	1.077	238	475	713	950	222	444	665	887

H1400

DIMENSIONE DIMENSIONS		LIBERO SU TUTTI I LATI FREE-STANDING				DELTA T (C°) POTENZA DISSIPABILE (W) POWER DISSIPATION CAPABILITY (W)				COPERTO SU RETRO E SU UN LATO			
		10°	20°	30°	40°	COPERTO SU RETRO WALL-PROP				10°	20°	30°	40°
L	P					10°	20°	30°	40°	10°	20°	30°	40°
600	400	157	314	471	628	139	277	416	554	126	253	379	505
600	500	176	351	527	702	157	314	471	628	142	283	425	567
800	400	191	382	573	764	166	333	499	665	154	308	462	616
800	500	211	422	633	844	186	373	559	745	171	342	513	684
1200	400	259	517	776	1.035	222	444	665	887	209	419	628	838
1200	500	282	564	845	1.127	245	490	735	979	229	459	688	918
1600	400	326	653	979	1.306	277	554	832	1.109	265	530	795	1.060
1600	500	353	705	1.058	1.411	303	607	910	1.214	288	576	864	1.152

Approfondimenti

Approfondimenti

Dissipazione armadi

Enclosures dissipation

H1600

DIMENSIONE DIMENSIONS		LIBERO SU TUTTI I LATI FREE-STANDING				COPERTO SU RETRO WALL-PROP				COPERTO SU RETRO E SU UN LATO			
		10°	20°	30°	40°	10°	20°	30°	40°	10°	20°	30°	40°
400	400	139	278	417	556	125	250	375	500	111	222	333	444
400	500	158	316	474	632	144	288	432	576	126	253	379	505
400	600	177	354	531	708	163	326	488	651	142	283	425	567
600	400	177	354	531	708	156	312	467	623	142	283	425	567
600	500	197	395	592	789	176	352	529	705	159	317	476	634
600	600	218	436	653	871	197	393	590	787	176	351	527	702
800	400	215	429	644	859	187	373	560	746	172	345	517	690
800	500	237	473	710	947	209	417	626	834	191	382	573	764
800	600	259	517	776	1.035	231	461	692	922	209	419	628	838
1000	400	253	505	758	1.010	217	435	652	869	203	407	610	813
1000	500	276	552	828	1.104	241	482	723	964	223	447	670	893
1000	600	300	599	899	1.199	264	529	793	1.058	243	487	730	973
1200	400	290	581	871	1.162	248	496	744	993	234	468	702	936
1200	500	315	631	946	1.262	273	546	820	1.093	256	511	767	1.023
1200	600	341	681	1.022	1.362	298	597	895	1.193	277	554	832	1.109

H1800

DIMENSIONE DIMENSIONS		LIBERO SU TUTTI I LATI FREE-STANDING				COPERTO SU RETRO WALL-PROP				COPERTO SU RETRO E SU UN LATO			
		10°	20°	30°	40°	10°	20°	30°	40°	10°	20°	30°	40°
300	300	114	228	342	455	102	204	306	408	90	180	270	360
300	400	134	268	402	536	122	244	366	488	106	213	319	425
300	500	154	308	462	616	142	284	427	569	122	245	367	490
300	600	174	348	523	697	162	325	487	649	139	277	416	554
300	800	215	429	644	858	203	405	608	810	171	342	513	684
300	1000	255	510	764	1.019	243	486	729	972	203	407	610	813
400	300	134	268	402	536	118	236	354	473	106	213	319	425
400	400	155	310	465	620	139	278	417	556	123	246	370	493
400	500	176	352	527	703	160	320	480	640	140	280	420	561
400	600	197	393	590	787	181	362	543	723	157	314	471	628
400	800	238	477	715	954	223	445	668	891	191	382	573	764
400	1000	280	561	841	1.121	264	529	793	1.058	225	450	675	899
600	300	174	348	523	697	150	301	451	602	139	277	416	554
600	400	197	393	590	787	173	346	519	692	157	314	471	628
600	500	219	438	657	876	195	391	586	781	176	351	527	702
600	600	242	483	725	966	218	436	653	871	194	388	582	776
600	800	286	573	859	1.146	263	525	788	1.051	231	462	693	924
600	1000	331	663	994	1.325	308	615	923	1.230	268	536	804	1.072
800	300	215	429	644	858	183	366	548	731	171	342	513	684
800	400	238	477	715	954	207	414	620	827	191	382	573	764
800	500	262	525	787	1.050	231	462	692	923	211	422	633	844
800	600	286	573	859	1.146	255	510	764	1.019	231	462	693	924
800	800	334	669	1.003	1.338	303	605	908	1.211	271	542	813	1.084
800	1000	382	765	1.147	1.529	351	701	1.052	1.403	311	622	933	1.244
1000	300	255	510	764	1.019	215	430	645	861	203	407	610	813
1000	400	280	561	841	1.121	241	481	722	963	225	450	675	899
1000	500	306	612	917	1.223	266	532	799	1.065	246	493	739	986
1000	600	331	663	994	1.325	292	583	875	1.167	268	536	804	1.072
1000	800	382	765	1.147	1.529	343	686	1.028	1.371	311	622	933	1.244
1000	1000	433	867	1.300	1.734	394	788	1.181	1.575	354	708	1.063	1.417
1200	300	295	590	885	1.180	248	495	743	990	236	471	707	942
1200	400	322	644	966	1.288	275	549	824	1.098	259	517	776	1.035
1200	500	349	698	1.047	1.397	302	603	905	1.206	282	564	845	1.127
1200	600	376	752	1.129	1.505	329	657	986	1.315	305	610	915	1.220
1200	800	430	861	1.291	1.721	383	766	1.148	1.531	351	702	1.053	1.404
1200	1000	484	969	1.453	1.938	437	874	1.311	1.748	397	795	1.192	1.589

■ Approfondimenti

Approfondimenti

Dissipazione armadi Enclosures dissipation

H2000

DIMENSIONE DIMENSIONS		LIBERO SU TUTTI I LATI FREE-STANDING				COPERTO SU RETRO WALL-PROP				COPERTO SU RETRO E SU UN LATO			
		10°	20°	30°	40°	10°	20°	30°	40°	10°	20°	30°	40°
300	300	126	251	377	503	113	225	338	450	99	199	298	397
300	400	148	296	444	591	135	269	404	539	117	234	351	468
300	500	170	340	510	680	157	314	470	627	135	270	404	539
300	600	192	384	576	768	179	358	537	715	152	305	457	610
300	800	236	473	709	945	223	446	669	892	188	376	564	752
300	1000	281	561	842	1.122	267	535	802	1.069	223	447	670	893
400	300	148	296	444	591	130	260	391	521	117	234	351	468
400	400	171	341	512	683	153	306	459	612	136	271	407	542
400	500	194	387	581	774	176	352	528	704	154	308	462	616
400	600	216	433	649	866	199	398	597	796	172	345	517	690
400	800	262	524	787	1.049	245	489	734	979	209	419	628	838
400	1000	308	616	924	1.232	290	581	871	1.162	246	493	739	986
600	300	192	384	576	768	166	331	497	663	152	305	457	610
600	400	216	433	649	866	190	380	570	760	172	345	517	690
600	500	241	482	723	964	215	429	644	858	193	385	578	770
600	600	265	531	796	1.061	239	478	717	956	213	425	638	850
600	800	314	628	942	1.257	288	576	863	1.151	253	505	758	1.010
600	1000	363	726	1.089	1.452	337	673	1.010	1.346	293	585	878	1.170
800	300	236	473	709	945	201	402	603	804	188	376	564	752
800	400	262	524	787	1.049	227	454	681	908	209	419	628	838
800	500	288	576	865	1.153	253	506	759	1.012	231	462	693	924
800	600	314	628	942	1.257	279	558	837	1.116	253	505	758	1.010
800	800	366	732	1.098	1.464	331	662	993	1.324	296	591	887	1.183
800	1000	418	836	1.254	1.672	383	766	1.148	1.531	339	678	1.016	1.355
1000	400	308	616	924	1.232	264	528	792	1.056	246	493	739	986
1000	500	336	671	1.007	1.342	292	583	875	1.166	270	539	809	1.078
1000	600	363	726	1.089	1.452	319	638	957	1.276	293	585	878	1.170
1000	800	418	836	1.254	1.672	374	748	1.122	1.496	339	678	1.016	1.355
1000	1000	473	946	1.419	1.892	429	858	1.287	1.716	385	770	1.155	1.540
1200	400	354	708	1.061	1.415	301	602	903	1.204	283	567	850	1.133
1200	500	383	766	1.148	1.531	330	660	990	1.320	308	616	924	1.232
1200	600	412	824	1.236	1.647	359	718	1.077	1.436	333	665	998	1.331
1200	800	470	940	1.410	1.880	417	834	1.251	1.668	382	764	1.146	1.528
1200	1000	528	1.056	1.584	2.112	475	950	1.426	1.901	431	862	1.294	1.725
1400	400	400	799	1.199	1.598	338	676	1.014	1.352	320	641	961	1.281
1400	500	430	860	1.290	1.720	369	737	1.106	1.474	347	693	1.040	1.386
1400	600	461	921	1.382	1.843	399	798	1.197	1.596	373	745	1.118	1.491
1400	800	522	1.044	1.566	2.087	460	920	1.381	1.841	425	850	1.275	1.700
1400	1000	583	1.166	1.749	2.332	521	1.043	1.564	2.086	477	955	1.432	1.910
1600	400	445	891	1.336	1.781	375	750	1.125	1.500	357	715	1.072	1.429
1600	500	477	955	1.432	1.910	407	814	1.221	1.628	385	770	1.155	1.540
1600	600	510	1.019	1.529	2.038	439	878	1.317	1.756	413	825	1.238	1.651
1600	800	574	1.148	1.721	2.295	503	1.007	1.510	2.013	468	936	1.404	1.873
1600	1000	638	1.276	1.914	2.552	568	1.135	1.703	2.270	524	1.047	1.571	2.094

■ Approfondimenti

Approfondimenti

Dissipazione armadi

Enclosures dissipation

DIMENSIONE DIMENSIONS		DELTA T (C°) POTENZA DISSIPABILE (W) POWER DISSIPATION CAPABILITY (W)											
		LIBERO SU TUTTI I LATI FREE-STANDING				COPERTO SU RETRO WALL-PROP				COPERTO SU RETRO E SU UN LATO BUILT-IN			
L	P	10°	20°	30°	40°	10°	20°	30°	40°	10°	20°	30°	40°
300	300	138	275	413	550	123	246	369	492	109	217	326	434
300	400	162	323	485	647	147	294	442	589	128	256	383	511
300	500	186	372	557	743	171	343	514	685	147	294	441	588
300	600	210	420	630	840	195	391	586	781	166	333	499	665
300	800	258	516	774	1.032	244	487	731	974	205	410	614	819
300	1000	306	612	919	1.225	292	583	875	1.167	243	487	730	973
400	300	162	323	485	647	142	285	427	569	128	256	383	511
400	400	187	373	560	746	167	334	502	669	148	296	444	591
400	500	211	423	634	846	192	384	576	768	168	336	504	671
400	600	236	473	709	945	217	434	651	868	188	376	564	752
400	800	286	572	858	1.144	267	533	800	1.067	228	456	684	912
400	1000	336	671	1.007	1.343	316	633	949	1.265	268	536	804	1.072
600	300	210	420	630	840	181	362	543	723	166	333	499	665
600	400	236	473	709	945	207	414	622	829	188	376	564	752
600	500	263	525	788	1.051	234	467	701	935	209	419	628	838
600	600	289	578	867	1.156	260	520	780	1.040	231	462	693	924
600	800	342	684	1.026	1.368	313	626	939	1.251	274	548	822	1.096
600	1000	395	789	1.184	1.579	366	731	1.097	1.463	317	634	952	1.269
800	300	258	516	774	1.032	219	439	658	877	205	410	614	819
800	400	286	572	858	1.144	247	495	742	989	228	456	684	912
800	500	314	628	942	1.256	275	550	826	1.101	251	502	753	1.004
800	600	342	684	1.026	1.368	303	606	909	1.213	274	548	822	1.096
800	800	398	796	1.193	1.591	359	718	1.077	1.436	320	641	961	1.281
800	1000	454	907	1.361	1.815	415	830	1.245	1.660	367	733	1.100	1.466
1000	400	336	671	1.007	1.343	287	575	862	1.149	268	536	804	1.072
1000	500	365	730	1.096	1.461	317	634	950	1.267	293	585	878	1.170
1000	600	395	789	1.184	1.579	346	693	1.039	1.385	317	634	952	1.269
1000	800	454	907	1.361	1.815	405	810	1.216	1.621	367	733	1.100	1.466
1000	1000	513	1.025	1.538	2.050	464	928	1.393	1.857	416	832	1.247	1.663
1200	400	385	771	1.156	1.542	327	655	982	1.309	308	616	924	1.232
1200	500	416	833	1.249	1.666	358	717	1.075	1.434	334	668	1.003	1.337
1200	600	447	895	1.342	1.790	389	779	1.168	1.558	360	721	1.081	1.441
1200	800	510	1.019	1.529	2.038	451	903	1.354	1.806	413	825	1.238	1.651
1200	1000	572	1.143	1.715	2.286	513	1.027	1.540	2.054	465	930	1.395	1.860
1400	400	435	870	1.305	1.741	367	735	1.102	1.470	348	696	1.044	1.392
1400	500	468	935	1.403	1.871	400	800	1.200	1.600	376	752	1.127	1.503
1400	600	500	1.001	1.501	2.001	433	865	1.298	1.730	403	807	1.210	1.614
1400	800	565	1.131	1.696	2.262	498	995	1.493	1.991	459	918	1.377	1.836
1400	1000	631	1.261	1.892	2.522	563	1.126	1.688	2.251	514	1.029	1.543	2.057
1600	400	485	970	1.455	1.940	407	815	1.222	1.630	388	776	1.164	1.552
1600	500	519	1.038	1.557	2.076	442	883	1.325	1.766	417	835	1.252	1.669
1600	600	553	1.106	1.659	2.212	476	951	1.427	1.903	447	893	1.340	1.786
1600	800	621	1.243	1.864	2.485	544	1.088	1.632	2.175	505	1.010	1.515	2.020
1600	1000	689	1.379	2.068	2.758	612	1.224	1.836	2.448	564	1.127	1.691	2.255

■ Approfondimenti

Approfondimenti

Certificazioni: tabella comparativa prodotti

Certifications: product comparison table

PRODOTTO PRODUCT	CEI EN 62208			TUV SD	TYPE	UL508A, UL50, C22.2 N. 14 95 AND CAN/CSA C22.2 N.94-M91	UL [®] US * C [®] RA [®] US	NORME SETTORE NAVALE SHIP BUILDING STANDARDS	PROVE DI TIPO ANTI-SISMICO SISMIC TESTS	TENUTA AL CORTO-CIRCUITO SECONDO CEI EN 61439-1-2 3500 A SHORT CIRCUIT-TEST AS PER CEI EN 61439-1- 2 3500 A	CERTIFICAZIONE CERTIFICATION EAC
	CE	IP	IK								
CDE	■	66	10		1,12,4	■		■			■
CDE Flange With flanges	■	55	10		1,12	■		■			■
CE	■	66	10	■	1,12,4	■		■	■		■
CE Doppia porta With double door	■	55	10	■	1,12	■		■	■		■
CE Porta vetro With glazed door	■	66	09	■				■			■
CQE	■	55	10	■	1,12,4	■		■	■	■	■
CQE Doppia porta With double door	■	55	10	■	1,12	■		■	■	■	■
CQE Porta vetro With glazed door	■	55	09	■				■		■	■
CQE Kit	■	55	10	■	1,12,4		■	■	■	■	■
CQE Kit porta doppia Kit double door	■	55	10	■	1,12		■	■	■	■	■
CQE Kit porta vetro Kit with glazed door	■	55	09	■				■		■	■
CQEC/CQEMC	■	55	10								
CAE	■	55	10	■	1,12,4	■		■	■		■
CAE Doppia porta With double door	■	55	10	■	1,12	■		■	■		■
CAE Porta vetro With glazed door	■	55	09					■			■
Pulpiti Consoles	■	55	10		1,12		■		■		■
Ventilazione/Filtri Fan-filters	■	54	-				■				
CE inox	■	66	10	■	1,12,4X	■		■			■
CE Inox doppia porta Inox double door	■	55	10	■	1,12	■		■			■
CDE inox	■	66	10	■	1,12,4X	■		■			■

■ Approfondimenti Approfondimenti

Verniciatura a polvere Powder painting

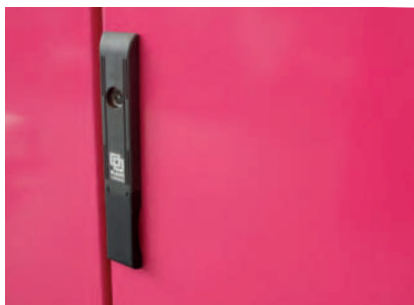

Il processo di verniciatura

La polvere viene caricata elettrostaticamente mediante il passaggio in pistole che la spruzzano all'interno della cabina di verniciatura.

Li è presente il pezzo da verniciare che è elettricamente messo a terra. In questo modo la nuvola di polvere viene attratta sulla superficie del pezzo andandosi a depositare uniformemente su di essa.

Subito dopo il pezzo viene portato in un forno nel quale segue un particolare ciclo termico che determina la reticolazione della polvere e ne favorisce l'attaccamento alla superficie metallica. Il pezzo rimane per circa 20 minuti ad una temperatura di 180°C.

Utilizzando diverse miscele di polvere si possono ottenere altrettante finiture. Nella nostra azienda vengono principalmente utilizzate le finiture di tipo "bucciato".

La polvere utilizzata è di tipo termoindurente a base di resine epossidiche, specificatamente formulate con pigmenti selezionati, cariche di additivi in grado di fornire film duri, flessibili e con ottime proprietà generali.

Lo spessore medio ottimale del film applicativo è compreso tra i 60 e gli 80 µm.

Preparazione del pezzo da verniciare

Nella prima fase i pezzi vengono sgrassati e fosfati con acqua a temperatura di circa 45°C a PH acido, segue un primo risciacquo con acqua di rete e un secondo con acqua demineralizzata mediamente inferiore a 30 µS, poi segue una fase di Passivazione alcalina nanotecnologica. infine l'asciugatura, il passaggio in forno con aria calda a ricircolo a 130°C per 6 minuti, il pezzo deve entrare in cabina di verniciatura completamente asciutto e pulito.

Controllo di processo

Tutto il ciclo di verniciatura è monitorato da un sistema software di gestione e rilevamento dati in tempo reale, questo strumento tramite un tablet permette agli operatori il controllo dei parametri di processo ed eventuali anomalie vengono segnalate, tutti i valori rilevati dagli strumenti confluiscono al software di registrazione dati, che memorizza i parametri e fornisce report ed elaborazione statistiche.

A fine ciclo vengono eseguiti i seguenti controlli:

- Controllo aderenza sistema di quadrettatura DIN EN ISO 2409
- Controllo colorazione visivo con provino a campione
- Controllo spessore film

Principali caratteristiche della verniciatura secondo la norma ISO 12944 ED. 2017

Durabilità

La durabilità di un ciclo di verniciatura è intesa come arco temporale prima del prossimo intervento di manutenzione straordinaria. In questo periodo è prevista la manutenzione ordinaria e un degrado del rivestimento.

La durabilità è normalmente espressa in intervalli temporali:

Bassa (Low) --> Fino a 7 anni
Media (medium) --> da 7 fino a 15 anni
Alta (High) --> da 15 a 25 anni
Molto alta (Very high) --> più di 25 anni

The painting process

The powder is electrostatically charged by passing it through guns that spray it inside the painting booth.

There is the piece to be painted which is electrically grounded. In this way the cloud of dust is attracted to the surface of the piece by going to settle uniformly on it. Immediately afterwards the piece is taken to an oven in which it follows a particular thermal cycle which determines the cross-linking of the powder and favors its attachment to the metal surface. The piece remains for about 20 minutes at a temperature of 180 ° C.

Using different powder mixtures, it is possible to obtain as many finishes.

In our company, the "textured" type finishes are mainly used.

The powder used is of a thermosetting type based on epoxy resins, specifically formulated with selected pigments, loaded with additives capable of providing hard, flexible films with excellent general properties.

The optimal average thickness of the application film is between 60 and 80 µm.

Preparation of the piece to be painted

In the first phase, the pieces are degreased and phosphated with water at a temperature of about 45 ° C at acid PH, followed by a first rinse with tap water and a second with demineralized water, on average less than 30 µS, then a Nanotechnological alkaline passivation phase. finally drying, passing through the oven with recirculated hot air at 130 ° C for 6 minutes, the piece must enter the painting booth completely dry and clean.

Process control

The entire painting cycle is monitored by a real-time data management and detection software system, this tool allows operators to control the process parameters and any anomalies are signaled, all the values detected by the tools flow together to the data logging software, which stores the parameters and provides reports and statistical processing.

At the end of the cycle the following checks are performed:

- Adherence check of the DIN EN ISO 2409 grid system
- Visual coloring control with sample specimen
- Film thickness control

Main characteristics of painting according to ISO 12944 ED. 2017

Durability

The durability of a painting cycle is intended as a time span before the next extraordinary maintenance intervention. Routine maintenance and deterioration of the coating is expected during this period.

Durability is normally expressed in time intervals:

Low (Low) -> Up to 7 years
Medium (medium) -> from 7 to 15 years
High (High) -> from 15 to 25 years
Very high -> over 25 years

■ Approfondimenti

Approfondimenti

Verniciatura a polvere - Informazioni generali

Powder painting - General informations

Classificazione degli ambienti di destinazione

Classification of target environments

In accordo ai contenuti della ISO 9223, gli ambienti sono classificati in sei categorie di corrosività:

According to the contents of ISO 9223, environments are classified into six corrosiveness categories:

CLASSE DI CORROSIVITÀ CORROSIVITY CATEGORY	AMBIENTE INTERNO INTERNAL ENVIRONMENT	AMBIENTE ESTERNO EXTERNAL ENVIRONMENT
C1	Ambienti riscaldati a bassa umidità. Esempio Uffici, Scuole, Musei Heated rooms with low humidity. Example Offices, Schools, Museums	-
C2	Spazi non riscaldati con temperatura ed umidità relativa variabili. Ad esempio magazzini o palestre Unheated spaces with variable temperature and relative humidity. For example warehouses or gyms	Zona temperata e ambiente con inquinamento molto ridotto come ad esempio aree rurali Temperate zone and environment with very low pollution such as rural areas
C3	Spazi con moderata frequenza di condensa e inquinamento moderato dovuto a processi produttivi. Spaces with moderate frequency of condensation and moderate pollution due to production processes.	Zona temperata e ambiente con inquinamento medio come ad esempio aree urbane o aree costiere con bassa deposizione di cloruri Temperate zone and environment with medium pollution such as urban areas or coastal areas with low chloride deposition
C4	Spazi con elevata frequenza di condensa ed inquinamento dovuto a processi produttivi. Spaces with high frequency of condensation and pollution due to production processes.	Zona temperata, ambiente atmosferico con elevato inquinamento. Ad esempio aree urbane inquinate oppure aree industriali Temperate zone, atmospheric environment with high pollution. For example polluted urban areas or industrial areas
C5	Spazi con frequenza di condensa molto elevata ed elevato inquinamento dovuto a processi produttivi Spaces with very high condensation frequency and high pollution due to production processes	Ambiente atmosferico con inquinamento molto elevato oppure con importante effetto di cloruri. Esempio aree industriali oppure aree costiere Atmospheric environment with very high pollution or with important effect of chlorides. Example industrial areas or coastal areas
CX	Aree industriali con condensa quasi permanente e con elevato inquinamento dovuto a processi produttivi Industrial areas with almost permanent condensation and with high pollution due to production processes	Aree offshore con elevata presenza di cloruri oppure aree industriali con umidità estrema e inquinamento molto elevato Offshore areas with high presence of chlorides or industrial areas with extreme humidity and very high pollution

Test per applicazione a prodotti in lamiera di acciaio verniciata, per l'attribuzione di una classe di corrosività

Test for application to painted steel sheet products, for the attribution of a corrosivity class

CLASSE DI CORROSIVITÀ CORROSIVITY CATEGORY ISO 12944-2	INTERVALLI DI DURATA DURABILITY RANGES ISO 12944-1	TEST REGIME 1			TEST REGIME 2
		ISO 2812-2 (IMMERSIONE IN ACQUA) (WATER IMMERSION)	ISO 6270-1 (CONDENSAZIONE ACQUA) (WATER CONDENSATION)	ISO 9227 (SOLUZIONE SALINA SPRAY) (NEUTRAL SALT SPRAY)	ANNEX B (TEST DI INVECCHIAMENTO CICLICO) (CYCLIC AGEING TEST)
C2	bassa low	-	48	-	-
	media medium	-	48	-	-
	alta high	-	120	-	-
	molto alta very high	-	240	480	-
C3	bassa low	-	48	120	-
	media medium	-	120	240	-
	alta high	-	240	480	-
	molto alta very high	-	480	720	-
C4	bassa low	-	120	240	-
	media medium	-	240	480	-
	alta high	-	480	720	-
	molto alta very high	-	720	1440	1680
C5	bassa low	-	240	480	-
	media medium	-	480	720	-
	alta high	-	720	1440	1680
	molto alta very high	-	-	-	2688

■ Approfondimenti

Approfondimenti

Ciclo di verniciatura standard RamBlock RamBlock standard painting procedure

Fase di pretrattamento

- Processo di fosfosgrassaggio acido: temperatura a 45°C.
- 1° risciacquo acqua di rete a temperatura ambiente.
- 2° risciacquo acqua demineralizzata a temperatura ambiente.
- Passivazione alcalina finale temperatura ambiente.
- Asciugatura in forno a 130°C.

Fase di trattamento e verniciatura

- Verniciatura elettrostatica a base di polveri epossipoliesteri o poliesteri con spessore approssimativo medio ottimale 60<micron>80.
- Polimerizzazione in forno 205°C.

Prove di controllo qualità in produzione

- controllo aderenza sistema della quadrettatura – ISO 2409
- controllo visivo mediante provino a campione
- controllo spessore film.

Pre-treatment

- Acid phosphodegreasing: temperature 45°C.
- 1st rinsing in network water at ambient temperature.
- 2nd rinsing in demineralized water at ambient temperature.
- Final alkaline passivation at ambient temperature.
- Oven drying at 130°C.

Treatment and painting

- Electrostatic painting whit epoxy polyester or polyester powder with the approximate average optimal thickness of 60<micron>80.
- Oven polymerizing at 205°C

Production quality control tests

- cross cut test – ISO 2409
- visual inspection of specimens
- Film thickness measurement.

Rapporto Report

[Lab. QUALITAL SERVIZI srl - RdP n° 45-19]

- test resistenza alla nebbia salina - ISO 9227 - ISO 12944-6
- controllo aderenza sistema della quadrettatura - ISO 2409

[Lab. QUALITAL SERVIZI srl – Test Rep. n. 45-19]

- sea - fog test - ISO 9227 - ISO 12944-6
- cross cut test - ISO 2409

TIPO DI TEST TEST TYPE	STANDARD	UNITÀ DI MISURA UNIT OF MEASUREMENT	VALORE VALUE	ESITO RESULT
Nebbia salina Sea-fog test	ISO 9227 -ISO12944-6	h	240	1 mm penetrazione corrosione sul taglio 1 mm corrosion penetration on the cut
Vescicamento Blistering	ISO 4628-2	h	240	0 (SO)
Arrugginimento Rusting	ISO 4628-3	h	240	Ri 0
Screpolatura Cracking	ISO 4628-4	h	240	0 (SO)
Sfogliamento Flaking	ISO 4628-5	h	240	0 (SO)
Corrosione Corrosion	ISO 4628-8	h	240	0 mm
Aderenza reticolo Lattice adherence	ISO 2409	-	GT 0	100%
Taglio - imbutitura Cutting - Drawing	DKC	-	Adesione Adherence	Distacco 1 mm dal taglio Detachment at 1 mm from the cut

Tabella RAL RAL table

Gli armadi e gli accessori DKC presenti sono disponibili in RAL 7035 bucciato. Tuttavia è possibile contattare la nostra rete di vendita per richiedere i prodotti DKC RamBlock nelle colorazioni qui di seguito elencate.

DKC enclosures and accessories presented on the catalog are available in RAL 7035 textured. However it's possible to contact our sales network to request DKC RamBlock products in the following colors listed below.



■ Approfondimenti

Approfondimenti

Cortocircuito

Short-circuit

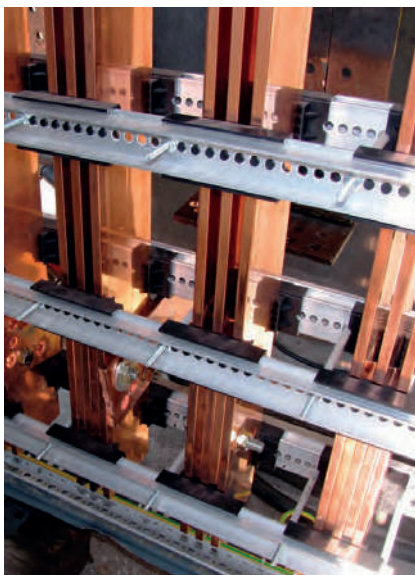

La prova di Corto Circuito si effettua per determinare la resistenza alle sollecitazioni dinamiche e termiche fino a raggiungere i valori massimi di cortocircuito stabiliti. La verifica di Corto Circuito, secondo IEC EN 61439-1-2, può essere effettuata con:

- Prove di tipo
- Regole di progetto
- Calcoli

Non è necessaria la verifica di tenuta al Corto Circuito nei seguenti casi:

- I_{cw} / I_{cc} minore o uguale a 10 kA
- per quadro elettrico protetto da limitatore di Corrente di Picco I_{pk} minore o uguale a 17 kA
- per circuiti ausiliari del quadro collegati a trasformatori con potenza nominale:
 1. minore o uguale a 10 kVA con una tensione nominale secondaria maggiore o uguale a 110 V
 2. minore o uguale a 1,6 kVA con una tensione nominale secondaria inferiore a 110 V
 3. la cui tensione di cortocircuito in entrambi i casi non sia inferiore al 4%
- per tutte le parti del quadro (barre principali, supporti delle barre principali, connessioni alle barre, unità di entrata e di uscita, apparecchi di protezione e manovra, etc.) che sono già state soggette a prove di verifica valide per le condizioni esistenti.

L'armadio CQE è stato sottoposto alle prove di Corto Circuito e alla verifica del Circuito di Protezione.

Dati Tecnici della Prova presso laboratorio ACAE LOVAG

Caratteristiche Nominali in accordo alla Classe 5.

Tensione d'impiego: 690 V.

Tensione d'isolamento: 1000 V.

Frequenza: 50/60 Hz.

Corrente Nominale Sistema a sbarre principale: 3500 A.

Tipo di corrente: alternata.

Verifica Tenuta al Corto Circuito

Circuiti Principali (3P test).

Corrente ammissibile di breve durata (I_{cw}):

80 kA / 1 sec.

Corrente di picco (I_{pk}): 176 kA.

Circuito di Protezione

Corrente ammissibile di breve durata (I_{cw}):

48 kA / 1 sec.

Corrente di picco (I_{pk}): 101 kA.

Verifica dell'effettiva continuità tra le masse dell'apparecchiatura e circuito di protezione

Corrente ammissibile di breve durata (I_{cw}):

48 kA / 1 sec.

Corrente di picco (I_{pk}): 101 kA.

$R = 0,98 \text{ m}\Omega$.

The short-circuit test is carried out in order to determine the resistance to dynamic and thermal stress up to achieving the maximum set short-circuit values.

The short-circuit verification, as per IEC EN 61439-1-2, may be carried out with:

- Type tests
- Design rules
- Calculations

A verification of short-circuit withstand strength is not necessary in the following cases:

- I_{cw} / I_{cc} is less than or equal to 10 kA
- for electrical assemblies protected with a delimitator of Peak Current less than or equal to 17kA
- for auxiliary circuits of a board connected to transformers with the nominal power:
 1. less or equal to 10 kVA with the nominal secondary voltage more or equal to 110 V
 2. less or equal to 1.6 kVA with the nominal secondary voltage less than 110 V
 3. the short-circuit voltage of which in both the cases is not less than 4%
- for all the board parts (main busbars, main busbar supports, connections to busbars, input and output units, safety and control devices, etc.), which have been already tested with valid results for the existing conditions.

CQE enclosure has passed the Short-Circuit tests and the Protection Circuit verification.

Technical Data of the Tests at ACAE LOVAG test laboratory

Nominal specifications as per Class 5.

Operating voltage: 690V.

Insulation voltage: 1000V.

Frequency: 50/60 Hz.

Nominal Current of main busbar system:

3500A.

Current type: alternating.

Short-circuit withstand strength Test

Main circuits (3P test).

Short-time withstand current (I_{cw}):

80 kA / 1 sec.

Peak withstand current (I_{pk}): 176 kA.

Protection circuit

Short-time withstand current (I_{cw}):

48 kA / 1 sec.

Peak withstand current (I_{pk}): 101 kA.

Verification of earth continuity between devices and protection circuit

Short-time withstand current (I_{cw}):

48 kA / 1 sec.

Peak withstand current (I_{pk}): 101 kA.

$R = 0,98 \text{ m}\Omega$.

■ Approfondimenti Approfondimenti

Circuito sbarre in rame Copper busbar circuit

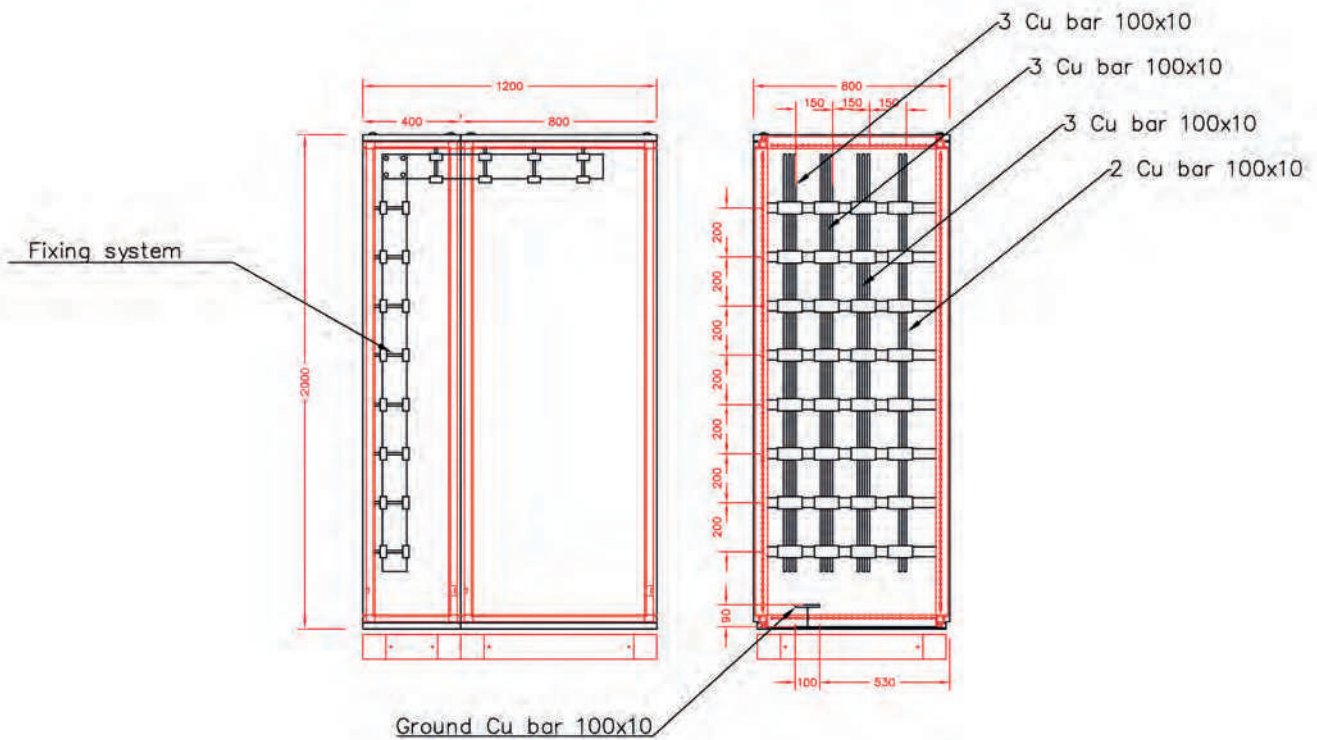

Dimensioni armadio Enclosure dimensions

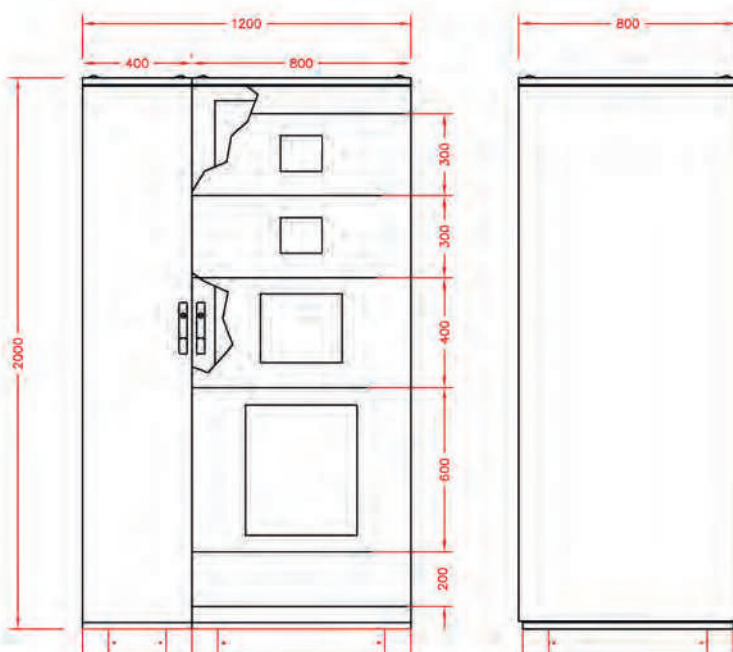

Certificato di conformità Test certificate



■ Approfondimenti

Approfondimenti

Tipi di segregazione secondo le normative vigenti

Types of separation according to standards in force

La necessità di realizzare quadri elettrici con un alto grado di sicurezza ed affidabilità viene affrontata seguendo la norma CEI EN 61439-2, che offre la possibilità di costruire quadri con separazioni interne, chiamate segregazioni, scomparti o celle con diverso valore e forma.

Le suddivisioni permettono di intervenire sui vari componenti per casi di manutenzione, sostituzione ed emergenza, senza dover togliere tensione al quadro.

Le separazioni interne vengono ottenute utilizzando i seguenti elementi:

- Diaframma: Con questa denominazione si intende una parte dell'involucro di una cella che serve a separare da altre celle.
- Barriera: Parte di protezione che assicura la protezione contro i contatti diretti che possono avvenire da qualsiasi direzione di accesso e contro gli archi elettrici provenienti dalle apparecchiature.

Le suddivisioni interne mediante barriere o diaframmi permettono di ottenere una protezione contro i contatti con parti attive di unità funzionali adiacenti e/o una protezione contro il passaggio di corpi solidi estranei da un'unità dell'apparecchiatura ad una adiacente.

Esistono diverse forme di segregazione, e sono classificate secondo quanto indicato nella tabella riportata.

Il tipo di segregazione adottato non è in funzione dell'impianto bensì in base agli accordi che vengono presi tra utilizzatore e produttore.

A necessity to construct electrical assemblies with a high level of safety and reliability is to be handled as per CEI EN 61439-2 standard, which offers a possibility to build electrical assemblies with internal separations, compartments or sections of various values and forms.

The separations allow servicing various components, making emergency substitutions without de-energising the assembly.

Internal separations are made with the following elements:

- Partitions: this denomination means a part of the enclosure of a compartment purposed to separate it from other compartments.
- Barrier: a part providing protection against direct contact from any usual direction of access, and against electrical arcs originated by functional units.

Internal separations made with the help of partitions or barriers allow obtaining a protection against contacts with live parts of adjacent functional units and/or a protection against the passage of foreign solid bodies from one unit of an assembly to an adjacent one.

There are different forms of separation, which are classified according to the following table.

The form of separation is not chosen in accordance with an assembly type, but is the subject of an agreement between assembly manufacturer and user.

■ Approfondimenti

Approfondimenti

Legenda per la lettura delle tabelle di segregazione secondo CEI EN 61439-2

Key for separation tables as per CEI EN 61439-2

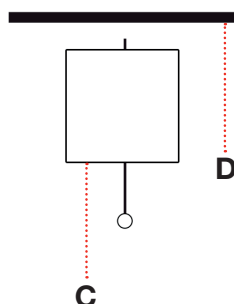
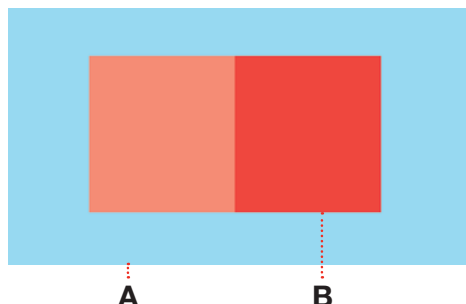

- A:** involucro
B: segregazione interna
C: unità funzionali, compresi terminali per conduttori esterni associati
D: sbarre, comprese le sbarre di distribuzione
- A: enclosure
 B: internal separation
 C: functional units including terminals for associated external conductors
 D: busbars including distribution busbars

CRITERIO PRINCIPALE PRIMARY CRITERION	CRITERIO SECONDARIO SECONDARY CRITERION	FORMA FORM
Nessuna separazione. No separation.	-	Forma 1 Form 1
Segregazione delle sbarre dalle unità funzionali. Separation of busbars from functional units.	Terminali per i conduttori esterni non separabili dalle sbarre. Terminals for conductors non separable from busbars.	Forma 2A Form 2A
Segregazione delle sbarre dalle unità funzionali. Separation of busbars from functional units.	Terminali per i conduttori esterni separati dalle sbarre. Terminals for conductors separable from busbars.	Forma 2B Form 2B
Seregazione delle sbarre dalle unità funzionali. Segregazione di tutte le unità funzionali l'una dall'altra. Segregazione dei terminali per i conduttori esterni dalle unità funzionali ma non l'uno dall'altro. Separation of busbars from functional units. Separation of all functional units from each other. Separation of terminals for external conductors from functional units but not from each other	Terminali per i conduttori esterni non separabili dalle sbarre. Terminals for conductors non separable from busbars.	Forma 3A Form 3A
Segregazione delle sbarre delle unità funzionali e segregazioni di tutte le unità funzionali l'una dall'altra, compresi i terminali per conduttori esterni, che sono parte integrante dell'unità funzionale. Separation of busbars from functional units and separation of all functional units from each other, including terminals for external conductors, which are an integral part of functional units.	Terminali per i conduttori esterni separati dalle sbarre. Terminals for conductors separable from busbars.	Forma 3B Form 3B
Segregazione delle sbarre delle unità funzionali e segregazioni di tutte le unità funzionali l'una dall'altra, compresi i terminali per conduttori esterni, che sono parte integrante dell'unità funzionale. Separation of busbars from functional units and separation of all functional units from each other, including terminals for external conductors, which are an integral part of functional units.	Terminali per i conduttori esterni nella stessa cella come le unità funzionali associate. Terminals for external conductors in the same compartment as the associated functional unit.	Forma 4A Form 4A
Segregazione delle sbarre delle unità funzionali e segregazioni di tutte le unità funzionali l'una dall'altra, compresi i terminali per conduttori esterni, che sono parte integrante dell'unità funzionale. Separation of busbars from functional units and separation of all functional units from each other, including terminals for external conductors, which are an integral part of functional units.	Terminali per i conduttori esterni non nella stessa cella come le unità funzionali associate ma in singoli spazi separati e racchiusi o in celle. Terminals for external conductors not in the same compartment as the associated functional unit, but in individual, separate, enclosed protected spaces and/or compartments.	Forma 4B Form 4B

■ Approfondimenti

Approfondimenti

Grado di protezione IP e NEMA IP and TYPE protection degree

IP - International Protection

Il grado di protezione IP definisce il livello di protezione degli involucri, dei dispositivi elettrici ed elettronici, contro la penetrazione di agenti esterni quali corpi solidi estranei, polveri o liquidi. Al prefisso IP vengono fatte seguire 2 cifre:

- la prima cifra definisce la protezione contro i corpi solidi
- la seconda cifra definisce la protezione contro i liquidi

Il codice IP è classificato secondo quanto prescritto dalla norma CEI EN 60529.

IP – International Protection

IP protection degree defines the protection level of enclosures of electrical and electronic devices against the ingress of external agents, such as foreign solid bodies, dust and liquids.

The IP prefix is followed by 2 digits:

- the first digit indicates a protection against the ingress of solid particles
- the second digit indicates a protection against the ingress of liquids

IP codes are classified as per CEI EN 60529 standard.

PRIMA CIFRA CARATTERISTICA (penetrazione corpi solidi) FIRST CHARACTERISTIC DIGIT (penetration of solid bodies)

0	Nessuna protezione Non-protected
1	Protezione contro i corpi solidi superiori a 50 mm (Protetto contro contatti accidentali) Protection against solid bodies exceeding 50 mm (Protected against accidental contacts)
2	Protezione contro i corpi solidi superiori a 12,5 mm (Protetto contro contatti delle dita) Protection against solid bodies over 12.5 mm (Protected against contact with the fingers)
3	Protezione contro i corpi solidi superiori a 2,5 mm (Protetto contro contatti con utensili) Protection against solid bodies exceeding 2.5 mm (Protected against contact with tools)
4	Protezione contro i corpi solidi superiori a 1 mm. (Protetto contro contatti con un filo) Protection against solid bodies exceeding 1 mm. (Protected against contact with a wire)
5	Protezione contro la polvere, nessun deposito nocivo Protection against dust, no harmful deposit
6	Totalmente protetto contro la polvere Totally protected against dust

SECONDA CIFRA CARATTERISTICA (ingresso di acqua) SECOND CHARACTERISTIC DIGIT (ingress of water)

0	Nessuna protezione Non-protected
1	Protezione contro la caduta verticale di gocce d'acqua. Protection against vertically falling drops of water.
2	Protezione contro la caduta verticale di gocce d'acqua con inclinazione dell'involucro fino a 15 Protection against vertically falling drops of water with inclination of the enclosure up to 15
3	Protezione contro l'acqua con angolo di caduta inferiore o uguale a 60 Protection against water with drop angle lower than or equal to 60
4	Protezione contro gli spruzzi da tutte le direzioni Protection against splashes from all directions
5	Protezione contro i getti d'acqua Protection against water jets
6	Protezione contro le ondate ed i getti d'acqua potenti Protection against waves and the powerful water jets
7	Protezione contro gli effetti di una immersione temporanea Protection against the effects of temporary immersion
8	Protezione contro gli effetti di una immersione continuata Protection against the effects of continuous immersion
9	Protezione contro i getti d'acqua ad alta pressione e a temperatura elevata Protection against high pressure and high temperature water jets

■ Approfondimenti

Approfondimenti

Grado di protezione IP e NEMA IP and TYPE protection degree

Type

La National Electrical Manufacturers Association o in sigla NEMA, è una associazione statunitense di produttori di materiale elettrico con lo scopo di definire standard comuni. La classificazione NEMA è molto simile al Sistema Europeo IP, con la differenza di utilizzare un solo numero per definire il livello di protezione contro l'introduzione di corpi solidi e liquidi all'interno dei dispositivi elettrici. I gradi di protezione NEMA sono contraddistinti dal termine TYPE. La tabella sottostante permette la conversione da NEMA a IP ma non viceversa.

Type

National Electrical Manufacturers Association, or NEMA as an acronym, is an American association of electrical manufacturers purposed to define common standards. NEMA classification is very similar to the European IP System with the difference of using only one digit to define a protection level against intrusion of solid objects and liquids insides electrical devices. NEMA protection degrees are distinguished by the term TYPE.

The below table allows converting NEMA to IP but not wise versa.

GRADO IP IP DEGREE	GRADO NEMA TYPE DEGREE	DESCRIZIONE DESCRIPTION
10	1	Uso primario interno per dare protezione contro limitate quantità di sporcizia. Indoor use for protection against limited quantities of dirt.
11	2	Uso primario interno per dare protezione contro una limitata quantità di sporcizia ed acqua. Indoor use for protection against limited quantities of dirt and water.
54	3	Uso primario esterno per dare protezione contro pioggia, grandine, polvere portata dal vento e danni per la formazione di ghiaccio all'esterno. Outdoor use for protection against rain, hail, windblown dust and damages caused by the external formation of ice.
14	3R	Uso primario all'esterno per dare protezione contro pioggia, grandine e formazione di ghiaccio all'esterno. Outdoor use for protection against rain, hail, damages caused by the external formation of ice.
54	3S	Uso primario esterno per dare protezione contro pioggia, grandine, polvere portata dal vento ed assicurare il funzionamento dei macchinari esterni con il ghiaccio. Outdoor use for protection against rain, hail, windblown dust and for provision of external devices good functioning with ice.
56	4	Uso primario sia interno sia esterno per dare protezione contro polvere portata dal vento e pioggia, spruzzi d'acqua, acqua diretta e danni per la formazione di ghiaccio all'esterno. Indoor and outdoor use for protection against windblown dust and rain, splashing water, hose-directed water, damages caused by the external formation of ice.
56	4X	Uso primario sia interno sia esterno per dare protezione contro corrosione, polvere portata dal vento e pioggia, spruzzi d'acqua, acqua diretta, danni per la formazione di ghiaccio all'esterno. Indoor and outdoor use for protection against corrosion, windblown dust and rain, splashing water, hose-directed water, damages caused by the external formation of ice.
52	5	Uso primario interno per dare protezione contro polveri in sospensione di sedimentazione, sporcizia e gocce di liquido non corrosivo. Indoor use for protection against airborne settling dust, dirt and dripping non-corrosive liquids.
67	6	Uso primario sia interno sia esterno per dare protezione contro acqua diretta, entrata di acqua durante una temporanea immersione in profondità limitata e danni per la formazione di ghiaccio all'esterno. Indoor and outdoor use for protection against hose-directed water, the entry of water during occasional temporary submersion at a limited depth, damages caused by the external formation of ice.
67	6P	Uso primario sia interno sia esterno per dare protezione contro acqua diretta, entrata di acqua durante un'immersione prolungata in profondità limitata e formazioni di ghiaccio all'esterno. Indoor and outdoor use for protection against hose-directed water, the entry of water during prolonged submersion at a limited depth, damages caused by the external formation of ice.
	7	Uso interno in postazioni classificate come Classe I, Divisione 1, Gruppo A, B, C o D, postazioni rischiose definite nel Codice Nazionale Elettrico (NFPA 70) (Generalmente riferito a prova di esplosioni). Indoor use in locations classified as Class I, Division 1, Groups A, B, C, or D, hazardous locations as defined in National Electrical Code (NFPA 70) (Normally referred to explosion tests).
	8	Uso interno in postazioni classificate come Classe I, Divisione 2, Gruppo A, B, C o D, postazioni rischiose definite nel Codice Nazionale Elettrico (NFPA 70) (generalmente riferito ad immersioni nell'olio). Indoor use in locations classified as Class I, Division 2, Groups A, B, C, or D, hazardous locations as defined in National Electrical Code (NFPA 70) (Normally referred to submersion into oils).
	9	Uso interno in postazioni classificate come Classe II, Divisione 1, Gruppo E, F e G, postazioni rischiose definite nel Codice Nazionale Elettrico (NEPA 70) (generalmente riferito a prova di polvere). Indoor use in locations classified as Class II, Division 1, Groups E, F, e G, hazardous locations as defined in National Electrical Code (NFPA 70) (Normally referred to dust exposure tests).
	10	Significa incontrare i requisiti della Mine Safety and Health Administration (MSHA). Conformity to Mine Safety and Health Administration (MSHA) requirements.
52	12 & 12K	Uso primario interno per dare protezione contro circolazione di polvere, sporcizia, gocce di liquido non corrosivo. Indoor use for protection against circulating dust, dirt, non-corrosive dripping liquids.
54	13	Uso primario interno per dare protezione contro polvere, spruzzi d'acqua, olio, refrigeranti non corrosivi. Indoor use for protection against dust, splashing water, oil, non-corrosive coolants.

Approfondimenti

Approfondimenti

Criteri di sollevamento

Lifting criteria

Carichi uniformemente distribuiti

Uniformly distributed loads

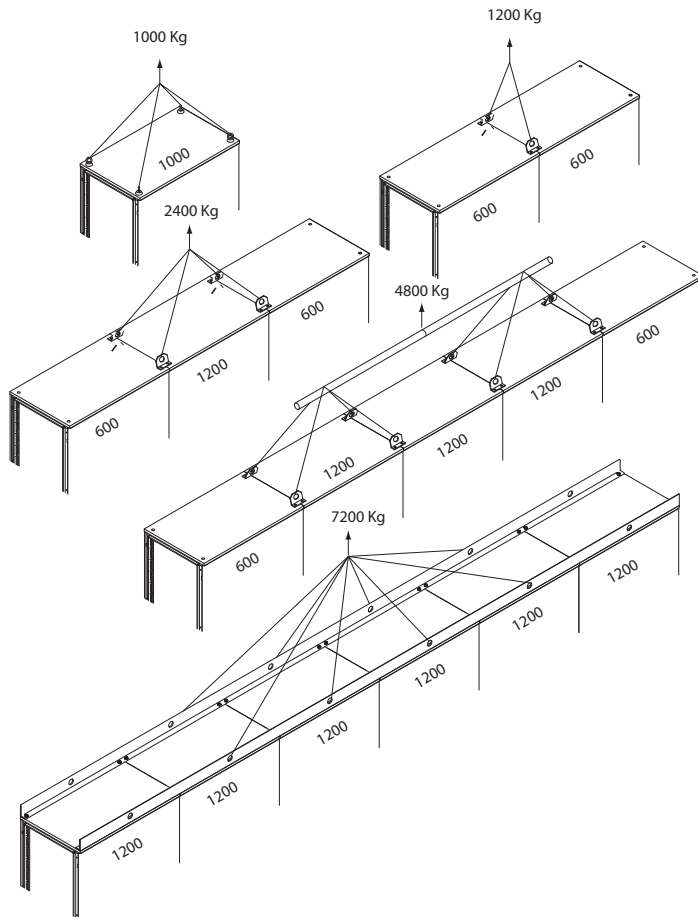

L'angolo tra le funi di sollevamento e il tetto dell'armadio deve essere $\geq 45^\circ$.
 Rif.: Norma DIN 580 sui golfari: la portata per la stessa misura di golfare varia tra: carico a tiro dritto applicato a un golfare (coassiale all'asse del filetto) Kg 340; carico a tiro inclinato applicato a due golfari con un'inclinazione massima di 45° tra l'asse del golfare e la fune di tiro Kg 240.

The angle between the lifting ropes and roof of the cabinet must be $\geq 45^\circ$.
 Ref.: Standard DIN 580 concerning lifting eyebolts: the lifting capacity for the same sized eyebolt varies between: straight pull load applied to one eyebolt (coaxial to thread axis) 340 kg; angle pull load applied to two eyebolts with a maximum angle of 45° between the axis of the eyebolt and the pulling rope 240 kg.



Angolo funi $>45^\circ$
Cable angle $>45^\circ$



DIN 580 per carico massimo
DIN 580 for maximum weight

Tetto Roof		60 Kg
Pannello laterale Side panel	$\leq L 600\text{mm}$	90 Kg
	$> L 600\text{mm}$	75 Kg
Pannello retro Back panel	$\leq L 600\text{mm}$	90 Kg
	$> L 600\text{mm}$	75 Kg
Porta cieca Blind door		75 Kg

Raccomandazioni

Recommendations

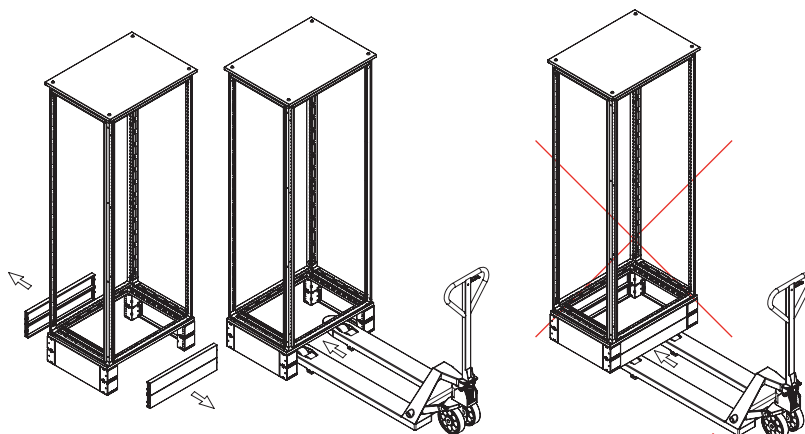

Non sollevare con flange montate
 Do not lift with mounted flanges

Per avere informazioni sul peso del singolo armadio consultare il sito internet

www.dkceurope.com

For information on the weight of the single wardrobe consult the website

www.dkceurope.com

■ Approfondimenti

Approfondimenti

Come ordinare un armadio in batteria

How to order a bayed enclosure system

Una batteria è composta da più armadi posti in fila ed assemblati in modo da essere solidali tra loro. Generalmente gli armadi appartenenti a una stessa batteria hanno anche la stessa altezza e la stessa profondità. Poniamo di voler ordinare una batteria di armadi come quella sottostante.

A bayed enclosure system is composed by several enclosures positioned in line and united together in order to create a solid joint between them. Normally enclosures belonging to the same bayed system have the same height and depth. Let us suppose that we have to order a bayed system like the one described below.

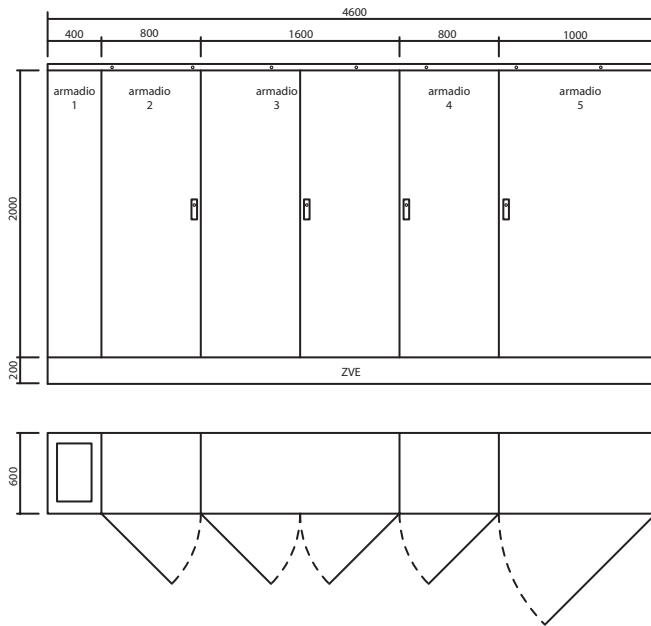

CODICE CODE	QUANTITÀ QUANTITY	NOTE NOTES
R5CQE2046S	1	Armadio 1 Enclosure 1
R5CQE2086	2	Armadio 2 e 4 Enclosure 2 and 4
R5CQE20166	1	Armadio 3 Enclosure 3
R5CQE20106	1	Armadio 5 Enclosure 5
RZPCE2080	2	Pann. cablaggio armadio 2 e 4 Mounting panel for enclosure 2 and 4
RZPCE20160	1	Pann. cablaggio armadio 3 Mounting panel for enclosure 3
RZPCE20100	1	Pann. cablaggio armadio 5 Mounting panel for enclosure 5
RZKE65	4	Kit unione armadi Enclosure baying kit
R5LE2062	1	Coppia laterali della batteria Pair of side panels for bayed system
R5CRE2040	2	Fronte e retro dell'armadio 1 Front and rear panels for enclosure 1
R1TSE01-XXX	4,6	Traversa di sollevamento Lifting rail
R1TSE01-XXX	4,6	Traversa di sollevamento Lifting rail
R1ZVE62	4,6	Zoccolo a vasca Blind plinth
RLAE22	4	Assemblaggio armadi in batteria Bayed system assembling

In questo caso la batteria è composta da 5 armadi alti 2000 e profondi 600, una coppia di laterali (2 pz. per confezione), uno zoccolo e le traverse di sollevamento. Per ogni giunzione tra un armadio e l'altro è necessario ordinare un kit unione **RZKE65** ed il relativo assemblaggio art. **RLAE22**. L'armadio 1, essendo largo 400 è considerato una risalita cavi e quindi il tetto è dotato già di cava e flangia di chiusura. Inoltre, in quanto risalita cavi (completamente chiusa nella parte anteriore e posteriore), deve essere ordinato come versione "S" ovvero solo struttura. In questo caso in sostituzione alla porta è presente un retro avvitato. Assieme all'ordine è preferibile fornire anche un disegno come quello sopra riportato in modo da comunicare il senso di apertura delle porte e la sequenza di fissaggio allo zoccolo. In caso contrario verrà seguito il nostro standard ovvero con maniglia sempre a sinistra della porta. In fase d'ordine è necessario comunicare anche il colore. Il nostro colore standard per le strutture è RAL 7035 con finitura tipo "bucciato". Per basi, tetti e zoccoli è utilizzato il colore RAL 7011 con finitura tipo "bucciato".

In this case the bayed system is composed by 5 enclosures, 2000 mm high and 600 mm deep, a pair of side panels (2 pieces per pack), a plinth and lifting rails. For each joint between one enclosure and another it is necessary to order a baying kit (code **RZKE65**) and the relative assembling service (code **RLAE22**).

The enclosure 1, being 400 mm wide, is considered as a cable chamber, so its roof is provided with a cable entry and a removable cover. Besides that, being a cable chamber (completely closed on the front and the rear side), it should be ordered in "S" version, which means a structure only. In this case instead of a door there is a screwed rear panel. It is preferable to provide a drawing along with the order, like the one given above, in order to communicate the direction of doors opening and the sequence of mounting to the plinth.

Otherwise our standard shall be applied, that is doors with a handle always on the left. It is also necessary to communicate the required color at the order. Our standard color for the structures is RAL 7035 with a textured finish. For bases, roofs and plinths textured RAL 7011 is used.

■ Indice Index

R1A46	158	R1TSE01-380	231	R1ZUE41-420	137	R1ZUE51-240	137
R1A47	158	R1TSE01-400	231	R1ZUE41-440	137	R1ZUE51-260	137
R1A48	158	R1TSE01-420	231	R1ZUE41-460	137	R1ZUE51-280	137
R1A49	158	R1TSE01-440	231	R1ZUE41-480	138	R1ZUE51-300	137
R1A61	158	R1TSE01-460	231	R1ZUE41-500	138	R1ZUE51-320	137
R1ARIT600	234	R1TSE01-480	231	R1ZUE41-520	138	R1ZUE51-340	137
R1ARIT800	234	R1TSE01-500	231	R1ZUE41-540	138	R1ZUE51-360	137
R1CE248	182	R1TSE01-520	231	R1ZUE41-560	138	R1ZUE51-380	137
R1KTB104	36	R1TSE01-540	231	R1ZUE41-580	138	R1ZUE51-400	137
R1KTB105	36	R1TSE01-560	231	R1ZUE41-600	138	R1ZUE51-420	137
R1KTB106	36	R1TSE01-580	231	R1ZUE41-620	138	R1ZUE51-440	137
R1KTB108	36	R1TSE01-600	231	R1ZUE41-640	138	R1ZUE51-460	137
R1KTB124	36	R1TSE01-620	231	R1ZUE41-660	138	R1ZUE51-480	138
R1KTB125	36	R1TSE01-640	231	R1ZUE41-680	138	R1ZUE51-500	138
R1KTB126	36	R1TSE01-660	231	R1ZUE41-700	138	R1ZUE51-520	138
R1KTB128	36	R1TSE01-680	231	R1ZUE41-720	139	R1ZUE51-540	138
R1KTB144	36	R1TSE01-700	231	R1ZUE41-740	139	R1ZUE51-560	138
R1KTB145	36	R1TSE01-720	231	R1ZUE42-080	139	R1ZUE51-580	138
R1KTB146	36	R1TSE01-760	231	R1ZUE42-100	139	R1ZUE51-600	138
R1KTB148	36	R1TSE03	232	R1ZUE42-120	139	R1ZUE51-620	138
R1KTB164	36	R1ZAE41	149	R1ZUE42-140	139	R1ZUE51-640	138
R1KTB165	36	R1ZAE42	149	R1ZUE42-160	139	R1ZUE51-660	138
R1KTB166	36	R1ZAE51	149	R1ZUE42-180	139	R1ZUE51-680	138
R1KTB168	36	R1ZAE52	149	R1ZUE42-200	139	R1ZUE51-700	138
R1KTB33	36	R1ZAE61	149	R1ZUE42-220	139	R1ZUE51-720	139
R1KTB34	36	R1ZAE62	149	R1ZUE42-240	139	R1ZUE51-740	139
R1KTB35	36	R1ZAE81	149	R1ZUE42-260	140	R1ZUE52-080	139
R1KTB36	36	R1ZAE82	149	R1ZUE42-280	140	R1ZUE52-100	139
R1KTB38	36	R1ZC20401	152	R1ZUE42-300	140	R1ZUE52-120	139
R1KTB43	36	R1ZC20402	152	R1ZUE42-320	140	R1ZUE52-140	139
R1KTB44	36	R1ZC20501	152	R1ZUE42-340	140	R1ZUE52-160	139
R1KTB45	36	R1ZC20502	152	R1ZUE42-360	140	R1ZUE52-180	139
R1KTB46	36	R1ZC20601	152	R1ZUE42-380	140	R1ZUE52-200	139
R1KTB48	36	R1ZC20602	152	R1ZUE42-400	140	R1ZUE52-220	139
R1KTB63	36	R1ZC20801	152	R1ZUE42-420	140	R1ZUE52-240	139
R1KTB64	36	R1ZC20802	152	R1ZUE42-440	140	R1ZUE52-260	140
R1KTB65	36	R1ZEA551	63	R1ZUE42-460	140	R1ZUE52-280	140
R1KTB66	36	R1ZEA552	63	R1ZUE42-480	140	R1ZUE52-300	140
R1KTB68	36	R1ZEA661	63	R1ZUE42-500	141	R1ZUE52-320	140
R1KTB83	36	R1ZEA662	63	R1ZUE42-520	141	R1ZUE52-340	140
R1KTB84	36	R1ZEA881	63	R1ZUE42-540	141	R1ZUE52-360	140
R1KTB85	36	R1ZEA882	63	R1ZUE42-560	141	R1ZUE52-380	140
R1KTB86	36	R1ZUE41-080	135	R1ZUE42-580	141	R1ZUE52-400	140
R1KTB88	36	R1ZUE41-100	135	R1ZUE42-600	141	R1ZUE52-420	140
R1TSE01-080	231	R1ZUE41-120	135	R1ZUE42-620	141	R1ZUE52-440	140
R1TSE01-100	231	R1ZUE41-140	135	R1ZUE42-640	141	R1ZUE52-460	140
R1TSE01-120	231	R1ZUE41-160	135	R1ZUE42-660	141	R1ZUE52-480	140
R1TSE01-140	231	R1ZUE41-180	135	R1ZUE42-680	141	R1ZUE52-500	141
R1TSE01-160	231	R1ZUE41-200	135	R1ZUE42-700	141	R1ZUE52-520	141
R1TSE01-180	231	R1ZUE41-220	135	R1ZUE42-720	142	R1ZUE52-540	141
R1TSE01-200	231	R1ZUE41-240	137	R1ZUE42-740	142	R1ZUE52-560	141
R1TSE01-220	231	R1ZUE41-260	137	R1ZUE51-080	135	R1ZUE52-580	141
R1TSE01-240	231	R1ZUE41-280	137	R1ZUE51-100	135	R1ZUE52-600	141
R1TSE01-260	231	R1ZUE41-300	137	R1ZUE51-120	135	R1ZUE52-620	141
R1TSE01-280	231	R1ZUE41-320	137	R1ZUE51-140	135	R1ZUE52-640	141
R1TSE01-300	231	R1ZUE41-340	137	R1ZUE51-160	135	R1ZUE52-660	141
R1TSE01-320	231	R1ZUE41-360	137	R1ZUE51-180	135	R1ZUE52-680	141
R1TSE01-340	231	R1ZUE41-380	137	R1ZUE51-200	135	R1ZUE52-700	141
R1TSE01-360	231	R1ZUE41-400	137	R1ZUE51-220	135	R1ZUE52-720	142

■ Indice Index

R1ZUE52-740	142	R1ZUE62-560	141	R1ZUE82-380	140	R1ZVE42-200	146
R1ZUE61-080	135	R1ZUE62-580	141	R1ZUE82-400	140	R1ZVE42-220	146
R1ZUE61-100	135	R1ZUE62-600	141	R1ZUE82-420	140	R1ZVE42-240	146
R1ZUE61-120	135	R1ZUE62-620	141	R1ZUE82-440	140	R1ZVE42-260	147
R1ZUE61-140	135	R1ZUE62-640	141	R1ZUE82-460	140	R1ZVE42-280	147
R1ZUE61-160	135	R1ZUE62-660	141	R1ZUE82-480	141	R1ZVE42-300	147
R1ZUE61-180	135	R1ZUE62-680	141	R1ZUE82-500	141	R1ZVE42-320	147
R1ZUE61-200	135	R1ZUE62-700	142	R1ZUE82-520	141	R1ZVE42-340	147
R1ZUE61-220	135	R1ZUE62-720	142	R1ZUE82-540	141	R1ZVE42-360	147
R1ZUE61-240	137	R1ZUE62-740	142	R1ZUE82-560	141	R1ZVE42-380	147
R1ZUE61-260	137	R1ZUE81-080	135	R1ZUE82-580	141	R1ZVE42-400	147
R1ZUE61-280	137	R1ZUE81-100	135	R1ZUE82-600	141	R1ZVE42-420	147
R1ZUE61-300	137	R1ZUE81-120	135	R1ZUE82-620	141	R1ZVE42-440	147
R1ZUE61-320	137	R1ZUE81-140	135	R1ZUE82-640	141	R1ZVE42-460	147
R1ZUE61-340	137	R1ZUE81-160	135	R1ZUE82-660	141	R1ZVE42-480	147
R1ZUE61-360	137	R1ZUE81-180	135	R1ZUE82-680	141	R1ZVE42-500	148
R1ZUE61-380	137	R1ZUE81-200	135	R1ZUE82-700	142	R1ZVE42-520	148
R1ZUE61-400	137	R1ZUE81-220	137	R1ZUE82-720	142	R1ZVE42-540	148
R1ZUE61-420	137	R1ZUE81-240	137	R1ZUE82-740	142	R1ZVE42-560	148
R1ZUE61-440	137	R1ZUE81-260	137	R1ZVE41-080	142	R1ZVE42-580	148
R1ZUE61-460	137	R1ZUE81-280	137	R1ZVE41-100	142	R1ZVE42-600	148
R1ZUE61-480	138	R1ZUE81-300	137	R1ZVE41-120	142	R1ZVE42-620	148
R1ZUE61-500	138	R1ZUE81-320	137	R1ZVE41-140	142	R1ZVE42-640	148
R1ZUE61-520	138	R1ZUE81-340	137	R1ZVE41-160	142	R1ZVE42-660	148
R1ZUE61-540	138	R1ZUE81-360	137	R1ZVE41-180	142	R1ZVE42-680	148
R1ZUE61-560	138	R1ZUE81-380	137	R1ZVE41-200	142	R1ZVE42-700	148
R1ZUE61-580	138	R1ZUE81-400	137	R1ZVE41-220	142	R1ZVE42-720	149
R1ZUE61-600	138	R1ZUE81-420	137	R1ZVE41-240	144	R1ZVE42-740	149
R1ZUE61-620	138	R1ZUE81-440	137	R1ZVE41-260	144	R1ZVE51-080	142
R1ZUE61-640	138	R1ZUE81-460	138	R1ZVE41-280	144	R1ZVE51-100	142
R1ZUE61-660	138	R1ZUE81-480	138	R1ZVE41-300	144	R1ZVE51-120	142
R1ZUE61-680	138	R1ZUE81-500	138	R1ZVE41-320	144	R1ZVE51-140	142
R1ZUE61-700	139	R1ZUE81-520	138	R1ZVE41-340	144	R1ZVE51-160	142
R1ZUE61-720	139	R1ZUE81-540	138	R1ZVE41-360	144	R1ZVE51-180	142
R1ZUE61-740	139	R1ZUE81-560	138	R1ZVE41-380	144	R1ZVE51-200	142
R1ZUE62-080	139	R1ZUE81-580	138	R1ZVE41-400	144	R1ZVE51-220	142
R1ZUE62-100	139	R1ZUE81-600	138	R1ZVE41-420	144	R1ZVE51-240	144
R1ZUE62-120	139	R1ZUE81-620	138	R1ZVE41-440	144	R1ZVE51-260	144
R1ZUE62-140	139	R1ZUE81-640	138	R1ZVE41-460	144	R1ZVE51-280	144
R1ZUE62-160	139	R1ZUE81-660	138	R1ZVE41-480	145	R1ZVE51-300	144
R1ZUE62-180	139	R1ZUE81-680	138	R1ZVE41-500	145	R1ZVE51-320	144
R1ZUE62-200	139	R1ZUE81-700	139	R1ZVE41-520	145	R1ZVE51-340	144
R1ZUE62-220	139	R1ZUE81-720	139	R1ZVE41-540	145	R1ZVE51-360	144
R1ZUE62-240	139	R1ZUE81-740	139	R1ZVE41-560	145	R1ZVE51-380	144
R1ZUE62-260	140	R1ZUE82-080	139	R1ZVE41-580	145	R1ZVE51-400	144
R1ZUE62-280	140	R1ZUE82-100	139	R1ZVE41-600	145	R1ZVE51-420	144
R1ZUE62-300	140	R1ZUE82-120	139	R1ZVE41-620	145	R1ZVE51-440	144
R1ZUE62-320	140	R1ZUE82-140	139	R1ZVE41-640	145	R1ZVE51-460	144
R1ZUE62-340	140	R1ZUE82-160	139	R1ZVE41-660	145	R1ZVE51-480	145
R1ZUE62-360	140	R1ZUE82-180	139	R1ZVE41-680	145	R1ZVE51-500	145
R1ZUE62-380	140	R1ZUE82-200	139	R1ZVE41-700	145	R1ZVE51-520	145
R1ZUE62-400	140	R1ZUE82-220	139	R1ZVE41-720	146	R1ZVE51-540	145
R1ZUE62-420	140	R1ZUE82-240	140	R1ZVE41-740	146	R1ZVE51-560	145
R1ZUE62-440	140	R1ZUE82-260	140	R1ZVE42-080	146	R1ZVE51-580	145
R1ZUE62-460	140	R1ZUE82-280	140	R1ZVE42-100	146	R1ZVE51-600	145
R1ZUE62-480	140	R1ZUE82-300	140	R1ZVE42-120	146	R1ZVE51-620	145
R1ZUE62-500	141	R1ZUE82-320	140	R1ZVE42-140	146	R1ZVE51-640	145
R1ZUE62-520	141	R1ZUE82-340	140	R1ZVE42-160	146	R1ZVE51-660	145
R1ZUE62-540	141	R1ZUE82-360	140	R1ZVE42-180	146	R1ZVE51-680	145

■ Indice Index

R1ZVE51-700	145	R1ZVE61-520	145	R1ZVE81-340	144	R5AF0451	428
R1ZVE51-720	146	R1ZVE61-540	145	R1ZVE81-360	144	R5AF0541	428
R1ZVE51-740	146	R1ZVE61-560	145	R1ZVE81-380	144	R5AF0551	428
R1ZVE52-080	146	R1ZVE61-580	145	R1ZVE81-400	144	R5APC1000	358
R1ZVE52-100	146	R1ZVE61-600	145	R1ZVE81-420	144	R5APC1200	358
R1ZVE52-120	146	R1ZVE61-620	145	R1ZVE81-440	144	R5APC1600	358
R1ZVE52-140	146	R1ZVE61-640	145	R1ZVE81-460	145	R5APC600	358
R1ZVE52-160	146	R1ZVE61-660	145	R1ZVE81-480	145	R5APC800	358
R1ZVE52-180	146	R1ZVE61-680	145	R1ZVE81-500	145	R5APV1000	362
R1ZVE52-200	146	R1ZVE61-700	146	R1ZVE81-520	145	R5APV1200	362
R1ZVE52-220	146	R1ZVE61-720	146	R1ZVE81-540	145	R5APV1600	362
R1ZVE52-240	146	R1ZVE61-740	146	R1ZVE81-560	145	R5APV600	362
R1ZVE52-260	147	R1ZVE62-080	146	R1ZVE81-580	145	R5APV800	362
R1ZVE52-280	147	R1ZVE62-100	146	R1ZVE81-600	145	R5CAE10103	108
R1ZVE52-300	147	R1ZVE62-120	146	R1ZVE81-620	145	R5CAE10103R	106
R1ZVE52-320	147	R1ZVE62-140	146	R1ZVE81-640	145	R5CAE10103S	104
R1ZVE52-340	147	R1ZVE62-160	146	R1ZVE81-660	145	R5CAE10103X	111
R1ZVE52-360	147	R1ZVE62-180	146	R1ZVE81-680	145	R5CAE10104	108
R1ZVE52-380	147	R1ZVE62-200	146	R1ZVE81-700	146	R5CAE10104R	106
R1ZVE52-400	147	R1ZVE62-220	146	R1ZVE81-720	146	R5CAE10104S	104
R1ZVE52-420	147	R1ZVE62-240	146	R1ZVE81-740	146	R5CAE10104X	111
R1ZVE52-440	147	R1ZVE62-260	147	R1ZVE82-080	146	R5CAE10124	119
R1ZVE52-460	147	R1ZVE62-280	147	R1ZVE82-100	146	R5CAE10124R	118
R1ZVE52-480	147	R1ZVE62-300	147	R1ZVE82-120	146	R5CAE10124S	116
R1ZVE52-500	148	R1ZVE62-320	147	R1ZVE82-140	146	R5CAE10144	119
R1ZVE52-520	148	R1ZVE62-340	147	R1ZVE82-160	146	R5CAE10144R	118
R1ZVE52-540	148	R1ZVE62-360	147	R1ZVE82-180	146	R5CAE10144S	116
R1ZVE52-560	148	R1ZVE62-380	147	R1ZVE82-200	146	R5CAE10164	119
R1ZVE52-580	148	R1ZVE62-400	147	R1ZVE82-220	146	R5CAE10164R	118
R1ZVE52-600	148	R1ZVE62-420	147	R1ZVE82-240	147	R5CAE10164S	116
R1ZVE52-620	148	R1ZVE62-440	147	R1ZVE82-260	147	R5CAE10184	119
R1ZVE52-640	148	R1ZVE62-460	147	R1ZVE82-280	147	R5CAE10184R	118
R1ZVE52-660	148	R1ZVE62-480	147	R1ZVE82-300	147	R5CAE10184S	116
R1ZVE52-680	148	R1ZVE62-500	148	R1ZVE82-320	147	R5CAE10204	119
R1ZVE52-700	148	R1ZVE62-520	148	R1ZVE82-340	147	R5CAE10204R	118
R1ZVE52-720	149	R1ZVE62-540	148	R1ZVE82-360	147	R5CAE10204S	116
R1ZVE52-740	149	R1ZVE62-560	148	R1ZVE82-380	147	R5CAE1063	108
R1ZVE61-080	142	R1ZVE62-580	148	R1ZVE82-400	147	R5CAE1063R	106
R1ZVE61-100	142	R1ZVE62-600	148	R1ZVE82-420	147	R5CAE1063S	104
R1ZVE61-120	142	R1ZVE62-620	148	R1ZVE82-440	147	R5CAE1063X	111
R1ZVE61-140	142	R1ZVE62-640	148	R1ZVE82-460	147	R5CAE1064	108
R1ZVE61-160	142	R1ZVE62-660	148	R1ZVE82-480	148	R5CAE1064R	106
R1ZVE61-180	142	R1ZVE62-680	148	R1ZVE82-500	148	R5CAE1064S	104
R1ZVE61-200	142	R1ZVE62-700	149	R1ZVE82-520	148	R5CAE1064X	111
R1ZVE61-220	142	R1ZVE62-720	149	R1ZVE82-540	148	R5CAE1083	108
R1ZVE61-240	144	R1ZVE62-740	149	R1ZVE82-560	148	R5CAE1083R	106
R1ZVE61-260	144	R1ZVE81-080	142	R1ZVE82-580	148	R5CAE1083S	104
R1ZVE61-280	144	R1ZVE81-100	142	R1ZVE82-600	148	R5CAE1083X	111
R1ZVE61-300	144	R1ZVE81-120	142	R1ZVE82-620	148	R5CAE1084	108
R1ZVE61-320	144	R1ZVE81-140	142	R1ZVE82-640	148	R5CAE1084R	106
R1ZVE61-340	144	R1ZVE81-160	142	R1ZVE82-660	148	R5CAE1084S	104
R1ZVE61-360	144	R1ZVE81-180	142	R1ZVE82-680	148	R5CAE1084X	111
R1ZVE61-380	144	R1ZVE81-200	142	R1ZVE82-700	149	R5CAE12103	108
R1ZVE61-400	144	R1ZVE81-220	144	R1ZVE82-720	149	R5CAE12103R	106
R1ZVE61-420	144	R1ZVE81-240	144	R1ZVE82-740	149	R5CAE12103S	104
R1ZVE61-440	144	R1ZVE81-260	144	R5AF0331	428	R5CAE12103X	111
R1ZVE61-460	144	R1ZVE81-280	144	R5AF0341	428	R5CAE12104	108
R1ZVE61-480	145	R1ZVE81-300	144	R5AF0431	428	R5CAE12104R	106
R1ZVE61-500	145	R1ZVE81-320	144	R5AF0441	428	R5CAE12104S	104

■ Indice
Index

R5CAE12104X	111	R5CAE1683	110	R5CAE1884	110	R5CAE2083	110
R5CAE1263	108	R5CAE1683R	107	R5CAE1884R	107	R5CAE2083R	107
R5CAE1263R	106	R5CAE1683S	105	R5CAE1884S	105	R5CAE2083S	105
R5CAE1263S	104	R5CAE1683V	115	R5CAE1884V	115	R5CAE2083V	115
R5CAE1263X	111	R5CAE1683X	113	R5CAE1884X	113	R5CAE2083X	113
R5CAE1264	108	R5CAE1684	110	R5CAE1885	110	R5CAE2084	110
R5CAE1264R	106	R5CAE1684R	107	R5CAE1885R	107	R5CAE2084R	107
R5CAE1264S	104	R5CAE1684S	105	R5CAE1885S	105	R5CAE2084S	105
R5CAE1264X	111	R5CAE1684V	115	R5CAE1885V	115	R5CAE2084V	115
R5CAE1283	108	R5CAE1684X	113	R5CAE1885X	113	R5CAE2084X	113
R5CAE1283R	106	R5CAE18104	110	R5CAE1886	110	R5CAE2085	110
R5CAE1283S	104	R5CAE18104R	107	R5CAE1886R	107	R5CAE2085R	107
R5CAE1283X	111	R5CAE18104S	105	R5CAE1886S	105	R5CAE2085S	105
R5CAE1284	108	R5CAE18104X	113	R5CAE1886V	115	R5CAE2085V	116
R5CAE1284R	106	R5CAE18105	110	R5CAE1886X	113	R5CAE2085X	113
R5CAE1284S	104	R5CAE18105R	107	R5CAE20104	110	R5CAE2086	110
R5CAE1284X	111	R5CAE18105S	105	R5CAE20104R	107	R5CAE2086R	107
R5CAE14103	110	R5CAE18105X	113	R5CAE20104S	105	R5CAE2086S	105
R5CAE14103R	107	R5CAE18106	110	R5CAE20104X	113	R5CAE2086V	116
R5CAE14103S	104	R5CAE18106R	107	R5CAE20105	110	R5CAE2086X	113
R5CAE14103X	111	R5CAE18106S	105	R5CAE20105R	107	R5CAE8124	119
R5CAE14104	110	R5CAE18106X	113	R5CAE20105S	105	R5CAE8124R	118
R5CAE14104R	107	R5CAE18124	110	R5CAE20105X	113	R5CAE8124S	116
R5CAE14104S	104	R5CAE18124R	107	R5CAE20106	110	R5CAE8144	119
R5CAE14104X	111	R5CAE18124S	105	R5CAE20106R	107	R5CAE8144R	118
R5CAE1463	110	R5CAE18124X	114	R5CAE20106S	105	R5CAE8144S	116
R5CAE1463R	107	R5CAE18125	110	R5CAE20106X	113	R5CAE8164	119
R5CAE1463S	104	R5CAE18125R	107	R5CAE20124	111	R5CAE8164R	118
R5CAE1463X	111	R5CAE18125S	105	R5CAE20124R	108	R5CAE8164S	116
R5CAE1464	110	R5CAE18125X	114	R5CAE20124S	105	R5CAE8184	119
R5CAE1464R	107	R5CAE18126	110	R5CAE20124X	114	R5CAE8184R	118
R5CAE1464S	104	R5CAE18126R	107	R5CAE20125	111	R5CAE8184S	116
R5CAE1464X	111	R5CAE18126S	105	R5CAE20125R	108	R5CAE8204	119
R5CAE1483	110	R5CAE18126X	114	R5CAE20125S	105	R5CAE8204R	118
R5CAE1483R	107	R5CAE1863	110	R5CAE20125X	114	R5CAE8204S	116
R5CAE1483S	104	R5CAE1863R	107	R5CAE20126	111	R5CAES1084	84,86
R5CAE1483X	111	R5CAE1863S	105	R5CAE20126R	108	R5CAES1084	86
R5CAE1484	110	R5CAE1863V	115	R5CAE20126S	105	R5CAES12104	84,86
R5CAE1484R	107	R5CAE1863X	113	R5CAE20126X	114	R5CAES12104	86
R5CAE1484S	104	R5CAE1864	110	R5CAE2063	110	R5CAES1484	84,86
R5CAE1484X	111	R5CAE1864R	107	R5CAE2063R	107	R5CAES1484	86
R5CAE16103	110	R5CAE1864S	105	R5CAE2063S	105	R5CAES16104	84,86
R5CAE16103R	107	R5CAE1864V	115	R5CAE2063V	115	R5CAES16104	86
R5CAE16103S	105	R5CAE1864X	113	R5CAE2063X	113	R5CAES1663	84,86
R5CAE16103X	113	R5CAE1865	110	R5CAE2064	110	R5CAES1663	86
R5CAE16104	110	R5CAE1865R	107	R5CAE2064R	107	R5CAES1664	84,86
R5CAE16104R	107	R5CAE1865S	105	R5CAE2064S	105	R5CAES1664	86
R5CAE16104S	105	R5CAE1865V	115	R5CAE2064V	115	R5CAES1684	84,86
R5CAE16104X	113	R5CAE1865X	113	R5CAE2064X	113	R5CAES1684	86
R5CAE1663	110	R5CAE1866	110	R5CAE2065	110	R5CAES18104	84,86,87
R5CAE1663R	107	R5CAE1866R	107	R5CAE2065R	107	R5CAES1884	84,86,87
R5CAE1663S	105	R5CAE1866S	105	R5CAE2065S	105	R5CAES1885	84,86,87
R5CAE1663V	115	R5CAE1866V	115	R5CAE2065V	115	R5CAES2084	84,86,87
R5CAE1663X	113	R5CAE1866X	113	R5CAE2065X	113	R5CC1000	360
R5CAE1664	110	R5CAE1883	110	R5CAE2066	110	R5CC1200	360
R5CAE1664R	107	R5CAE1883R	107	R5CAE2066R	107	R5CC1600	360
R5CAE1664S	105	R5CAE1883S	105	R5CAE2066S	105	R5CC600	360
R5CAE1664V	115	R5CAE1883V	115	R5CAE2066V	115	R5CC800	360
R5CAE1664X	113	R5CAE1883X	113	R5CAE2066X	113	R5CDE11120	320

■ Indice Index

R5CDE1180	320	R5CE0613	300	R5CEXD0862	302	R5CPE2280	169
R5CDE22120	320	R5CE0642	299	R5CEXD1062	302	R5CPE2281	171
R5CDE22120C	321	R5CE0644	299	R5CEXD1262	302	R5CPE8120	120
R5CDE2280	320	R5CE0649	299	R5CPC1000	357,368	R5CPE8140	120
R5CDE2280C	321	R5CE0664	299	R5CPC1200	357,368	R5CPE8160	120
R5CDE2980	320	R5CE0669	299	R5CPC1600	357,368	R5CPE8180	120
R5CDE31120	320	R5CE0683	300	R5CPC600	357,368	R5CPE8200	120
R5CDE3180	320	R5CE0752	299	R5CPC800	357,368	R5CPFE6100	246
R5CDE32120	320	R5CE0759	299	R5CPE10100	168	R5CPFE8100	246
R5CDE32120C	321	R5CE0812	300	R5CPE10120	120	R5CPLE1850	175
R5CDE32120F	323	R5CE08123	300	R5CPE10140	120	R5CPLE1860	175
R5CDE3280	320	R5CE0813	300	R5CPE10160	120	R5CPLE1880	175
R5CDE3280C	321	R5CE0863	299	R5CPE10180	120	R5CPLE2050	175
R5CDE33120	320	R5CE0864	299	R5CPE10200	120	R5CPLE2060	175
R5CDE33120C	321	R5CE0869	299	R5CPE1060	168	R5CPLE2080	175
R5CDE33120F	323	R5CE0883	299	R5CPE1080	168	R5CPLE2250	175
R5CDE42120	320	R5CE0884	299	R5CPE12100	168	R5CPLE2260	175
R5CDE42120C	321	R5CE1013	300	R5CPE12101	169	R5CPLE2280	175
R5CDE42120F	323	R5CE1063	299	R5CPE12120	169	R5CPME6200	250
R5CDE4280	320	R5CE1064	299	R5CPE1240	168	R5CPME6201	252
R5CDE4280C	321	R5CE1069	299	R5CPE1260	168	R5CPME6300	250
R5CDE43120	320	R5CE1083	299	R5CPE1280	168	R5CPME6400	250
R5CDE43120C	321	R5CE1084	299	R5CPE14100	168	R5CPME6401	252
R5CDE43120F	323	R5CE12123	300	R5CPE14120	169	R5CPME6500	250
R5CDE44120	320	R5CE1213	300	R5CPE14160	169	R5CPME6600	250
R5CDE44120F	323	R5CE1263	299	R5CPE1460	168	R5CPME6800	250
R5CDE52120	321	R5CE1264	299	R5CPE1480	168	R5CPME6900	250
R5CDE52120C	321	R5CE1283	299	R5CPE1481	169	R5CPME8200	250
R5CDE52120F	323	R5CE1284	299	R5CPE16100	168	R5CPME8201	252
R5CDE53120	321	R5CE1413	300	R5CPE16101	169	R5CPME8300	250
R5CDE53120F	323	R5CE1463	299	R5CPE16120	169	R5CPME8400	250
R5CDE62120	321	R5CE1483	299	R5CPE1640	168	R5CPME8401	252
R5CDE62120F	323	R5CEMC0442	78	R5CPE1660	168	R5CPME8500	250
R5CDE6280	321	R5CEMC0642	78	R5CPE1680	168	R5CPME8600	250
R5CDE63120	321	R5CEMC0669	78	R5CPE1681	169	R5CPME8800	250
R5CDE63120F	323	R5CEX0432	301	R5CPE18100	169	R5CPME8900	250
R5CDE64120	321	R5CEX0442	301	R5CPE18101	169	R5CPMIE6400	254
R5CDE64120F	323	R5CEX0462	301	R5CPE18120	169	R5CPMIE6600	254
R5CDE82120	321	R5CEX0532	301	R5CPE1830	169	R5CPMIE6800	254
R5CDE82120F	323	R5CEX0542	301	R5CPE1840	169	R5CPMIE8400	254
R5CDE8280	321	R5CEX0549	301	R5CPE1860	169	R5CPMIE8600	254
R5CDE84120	321	R5CEX0552	301	R5CPE1880	169	R5CPMIE8800	254
R5CDE84120F	323	R5CEX0642	301	R5CPE1881	169	R5CPMTE6400	252
R5CDE9180	320	R5CEX0649	301	R5CPE20100	169	R5CPMTE6600	252
R5CDEMC33120	79	R5CEX0664	301	R5CPE20101	171	R5CPMTE6800	252
R5CDEMC53120	79	R5CEX0669	301	R5CPE20120	171	R5CPMTE8400	252
R5CE0331	298	R5CEX0752	301	R5CPE20140	171	R5CPMTE8600	252
R5CE0341	298	R5CEX0759	301	R5CPE20160	171	R5CPMTE8800	252
R5CE0391	298	R5CEX0863	302	R5CPE2030	169	R5CPTE10100	171
R5CE0431	298	R5CEX0864	302	R5CPE2040	169	R5CPTE1060	171
R5CE0432	298	R5CEX0869	302	R5CPE2060	169	R5CPTE1080	171
R5CE0442	298	R5CEX1063	302	R5CPE2080	169	R5CPTE12100	171
R5CE0462	298	R5CEX1069	302	R5CPE2081	171	R5CPTE1260	171
R5CE0531	298	R5CEX1083	302	R5CPE22100	169	R5CPTE1280	171
R5CE0532	298	R5CEX1084	302	R5CPE22101	171	R5CPTE14100	171
R5CE0542	298	R5CEX1263	302	R5CPE22120	171	R5CPTE1460	171
R5CE0549	298	R5CEX1264	302	R5CPE2230	169	R5CPTE1480	171
R5CE0552	298	R5CEX1283	302	R5CPE2240	169	R5CPTE16100	171
R5CE06123	300	R5CEXD0662	302	R5CPE2260	169	R5CPTE1660	171

■ Indice Index

R5CPTE1680	171	R5CQE1265R	42	R5CQE16104	48	R5CQE1666X	58
R5CPTE18100	171	R5CQE1265S	38	R5CQE161041	52	R5CQE1684	48
R5CPTE18120	171	R5CQE1265X	56	R5CQE16104R	43	R5CQE16841	52
R5CPTE1860	171	R5CQE1266	46	R5CQE16104S	39	R5CQE1684R	43
R5CPTE1880	171	R5CQE1266R	42	R5CQE16104T	54	R5CQE1684S	39
R5CPTE20100	173	R5CQE1266S	38	R5CQE16104X	58	R5CQE1684T	54
R5CPTE20120	173	R5CQE1266X	56	R5CQE16105	48	R5CQE1684V	60
R5CPTE2060	173	R5CQE1284	46	R5CQE161051	52	R5CQE1684X	58
R5CPTE2080	173	R5CQE12841	51	R5CQE16105R	43	R5CQE1685	48
R5CPTE22100	173	R5CQE1284R	42	R5CQE16105S	39	R5CQE16851	52
R5CPTE22120	173	R5CQE1284S	38	R5CQE16105T	54	R5CQE1685R	43
R5CPTE2260	173	R5CQE1284X	56	R5CQE16105X	58	R5CQE1685S	39
R5CPTE2280	173	R5CQE1285	46	R5CQE16106	48	R5CQE1685T	54
R5CPTE1660	173	R5CQE12851	51	R5CQE161061	52	R5CQE1685V	60
R5CPTE1680	173	R5CQE1285R	42	R5CQE16106R	43	R5CQE1685X	58
R5CPTE1860	173	R5CQE1285S	38	R5CQE16106S	39	R5CQE1686	48
R5CPTE1880	173	R5CQE1285X	56	R5CQE16106T	54	R5CQE16861	52
R5CPTE1860	173	R5CQE1286	46	R5CQE16106X	58	R5CQE1686R	43
R5CPTE1860	173	R5CQE12861	51	R5CQE16124	48,52	R5CQE1686S	39
R5CPTE1860	173	R5CQE1286R	42	R5CQE16124R	43	R5CQE1686T	54
R5CPV1000	361,370	R5CQE1286S	38	R5CQE16124S	39	R5CQE1686V	60
R5CPV1200	361,370	R5CQE14124	48,52	R5CQE16124T	54	R5CQE1686X	58
R5CPV1600	361,370	R5CQE14124R	43	R5CQE16125	48,52	R5CQE181010	49
R5CPV600	361,370	R5CQE14124S	38	R5CQE16125R	43	R5CQE1810101	52
R5CPV800	361,370	R5CQE14124T	54	R5CQE16125S	39	R5CQE181010R	44
R5CQE12104	46	R5CQE14125	48,52	R5CQE16125T	54	R5CQE181010S	40
R5CQE121041	51	R5CQE14125R	43	R5CQE16126	48,52	R5CQE181010X	58
R5CQE12104R	42	R5CQE14125S	38	R5CQE16126R	43	R5CQE18104	49
R5CQE12104S	38	R5CQE14125T	54	R5CQE16126S	39	R5CQE181041	52
R5CQE12105	46	R5CQE14164	48,52	R5CQE16126T	54	R5CQE18104R	44
R5CQE121051	51	R5CQE14164R	43	R5CQE1644	48	R5CQE18104S	39
R5CQE12105R	42	R5CQE14164S	38	R5CQE1644R	43	R5CQE18104T	55
R5CQE12105S	38	R5CQE14164T	54	R5CQE1644S	39	R5CQE18104X	58
R5CQE12106	46	R5CQE14165	48,52	R5CQE1644T	54	R5CQE18105	49
R5CQE121061	51	R5CQE14165R	43	R5CQE1645	48	R5CQE181051	52
R5CQE12106R	42	R5CQE14165S	39	R5CQE1645R	43	R5CQE18105R	44
R5CQE12106S	38	R5CQE14165T	54	R5CQE1645S	39	R5CQE18105S	40
R5CQE12124	46,51	R5CQE1464	48	R5CQE1645T	54	R5CQE18105T	55
R5CQE12124R	42	R5CQE1464R	43	R5CQE1646	48	R5CQE18105X	58
R5CQE12124S	38	R5CQE1464S	38	R5CQE1646R	43	R5CQE18106	49
R5CQE12125	46,51	R5CQE1464T	54	R5CQE1646S	39	R5CQE181061	52
R5CQE12125R	42	R5CQE1464X	56	R5CQE1646T	54	R5CQE18106R	44
R5CQE12125S	38	R5CQE1465	48	R5CQE1664	48	R5CQE18106S	40
R5CQE12126	46,51	R5CQE1465R	43	R5CQE1664R	43	R5CQE18106T	55
R5CQE12126R	42	R5CQE1465S	38	R5CQE1664S	39	R5CQE18106X	58
R5CQE12126S	38	R5CQE1465T	54	R5CQE1664T	54	R5CQE18108	49
R5CQE1244	46	R5CQE1465X	56	R5CQE1664V	60	R5CQE181081	52
R5CQE1244R	42	R5CQE1484	48	R5CQE1664X	58	R5CQE18108R	44
R5CQE1244S	38	R5CQE14841	52	R5CQE1665	48	R5CQE18108S	40
R5CQE1245	46	R5CQE1484R	43	R5CQE1665R	43	R5CQE18108T	55
R5CQE1245R	42	R5CQE1484S	38	R5CQE1665S	39	R5CQE18108X	58
R5CQE1245S	38	R5CQE1484T	54	R5CQE1665T	54	R5CQE181210	49,52
R5CQE1246	46	R5CQE1484X	56	R5CQE1665V	60	R5CQE181210R	44
R5CQE1246R	42	R5CQE1485	48	R5CQE1665X	58	R5CQE181210S	40
R5CQE1246S	38	R5CQE14851	52	R5CQE1666	48	R5CQE181210X	58
R5CQE1264	46	R5CQE1485R	43	R5CQE1666R	43	R5CQE18124	49,52
R5CQE1264R	42	R5CQE1485S	38	R5CQE1666S	39	R5CQE18124R	44
R5CQE1264S	38	R5CQE1485T	54	R5CQE1666T	54	R5CQE18124S	40
R5CQE1264X	56	R5CQE1485X	56	R5CQE1666V	60	R5CQE18124T	55
R5CQE1265	46						

■ Indice Index

R5CQE18124X	58	R5CQE18610V	60	R5CQE1886R	44,245,264	R5CQE20126T	55
R5CQE18125	49,52	R5CQE18610X	58	R5CQE1886S	39	R5CQE20126X	59
R5CQE18125R	44	R5CQE1863	48	R5CQE1886T	55	R5CQE20128	50,53
R5CQE18125S	40	R5CQE1863R	43	R5CQE1886V	60	R5CQE20128R	45
R5CQE18125T	55	R5CQE1863S	39	R5CQE1886X	58,265	R5CQE20128S	40
R5CQE18125X	58	R5CQE1863V	60	R5CQE1888	49	R5CQE20128T	55
R5CQE18126	49,52	R5CQE1863X	58	R5CQE18881	52	R5CQE20128X	59
R5CQE18126R	44	R5CQE1864	48	R5CQE1888R	44,245,264	R5CQE201410	50,53
R5CQE18126S	40	R5CQE1864R	43,245,264	R5CQE1888S	39	R5CQE201410R	45
R5CQE18126T	55	R5CQE1864S	39	R5CQE1888T	55	R5CQE201410S	41
R5CQE18126X	58	R5CQE1864T	54	R5CQE1888V	60	R5CQE20144	50,53
R5CQE18128	49,52	R5CQE1864V	60	R5CQE1888X	58,265	R5CQE20144R	45
R5CQE18128R	44	R5CQE1864X	58,265	R5CQE201010	49	R5CQE20144S	40
R5CQE18128S	40	R5CQE1865	48	R5CQE2010101	53	R5CQE20144T	55
R5CQE18128T	55	R5CQE1865R	43,245,264	R5CQE201010R	44	R5CQE20145	50,53
R5CQE18128X	58	R5CQE1865S	39	R5CQE201010S	40	R5CQE20145R	45
R5CQE18310	48	R5CQE1865T	54	R5CQE201010X	59	R5CQE20145S	40
R5CQE18310R	43	R5CQE1865V	60	R5CQE20104	49	R5CQE20145T	55
R5CQE18310S	39	R5CQE1865X	58,265	R5CQE201041	53	R5CQE20146	50,53
R5CQE1833	48	R5CQE1866	48	R5CQE20104R	44	R5CQE20146R	45
R5CQE1833R	43	R5CQE1866R	43,245,264	R5CQE20104S	40	R5CQE20146S	41
R5CQE1833S	39	R5CQE1866S	39	R5CQE20104T	55	R5CQE20146T	55
R5CQE1834	48	R5CQE1866T	54	R5CQE20104X	59	R5CQE20148	50,53
R5CQE1834R	43	R5CQE1866V	60	R5CQE20105	49	R5CQE20148R	45
R5CQE1834S	39	R5CQE1866X	58,265	R5CQE201051	53	R5CQE20148S	41
R5CQE1835	48	R5CQE1868	48	R5CQE20105R	44	R5CQE20148T	55
R5CQE1835R	43	R5CQE1868R	43,245,264	R5CQE20105S	40	R5CQE201610	50,53
R5CQE1835S	39	R5CQE1868S	39	R5CQE20105T	55	R5CQE201610R	45
R5CQE1836	48	R5CQE1868T	54	R5CQE20105X	59	R5CQE201610S	41
R5CQE1836R	43	R5CQE1868V	60	R5CQE20106	49	R5CQE20164	50,53
R5CQE1836S	39	R5CQE1868X	58,265	R5CQE201061	53	R5CQE20164R	45
R5CQE1838	48	R5CQE18810	49	R5CQE201061T	55	R5CQE20164S	41
R5CQE1838R	43	R5CQE188101	52	R5CQE20106R	44	R5CQE20164T	55
R5CQE1838S	39	R5CQE18810R	44	R5CQE20106S	40	R5CQE20165	50,53
R5CQE18410	48	R5CQE18810S	39	R5CQE20106T	55	R5CQE20165R	45
R5CQE18410R	43	R5CQE18810V	61	R5CQE20106X	59	R5CQE20165S	41
R5CQE18410S	39	R5CQE18810X	58	R5CQE20108	49	R5CQE20165T	55
R5CQE1843	48	R5CQE1883	49	R5CQE201081	53	R5CQE20166	50,53
R5CQE1843R	43	R5CQE18831	52	R5CQE20108R	44	R5CQE20166R	45
R5CQE1843S	39	R5CQE1883R	44	R5CQE20108S	40	R5CQE20166S	41
R5CQE1844	48	R5CQE1883S	39	R5CQE20108T	55	R5CQE20166T	55
R5CQE1844R	43	R5CQE1883V	60	R5CQE20108X	59	R5CQE20168	50,53
R5CQE1844S	39	R5CQE1883X	58	R5CQE201210	50,53	R5CQE20168R	45
R5CQE1844T	54	R5CQE1884	49	R5CQE201210R	45	R5CQE20168S	41
R5CQE1845	48	R5CQE18841	52	R5CQE201210S	40	R5CQE20168T	55
R5CQE1845R	43	R5CQE1884R	44,245,264	R5CQE201210X	59	R5CQE20310	49
R5CQE1845S	39	R5CQE1884S	39	R5CQE20124	50,53	R5CQE20310R	44
R5CQE1845T	54	R5CQE1884T	54	R5CQE20124R	45	R5CQE20310S	40
R5CQE1846	48	R5CQE1884V	60	R5CQE20124S	40	R5CQE2033	49
R5CQE1846R	43	R5CQE1884X	58,265	R5CQE20124T	55	R5CQE2033R	44
R5CQE1846S	39	R5CQE1885	49	R5CQE20124X	59	R5CQE2033S	40
R5CQE1846T	54	R5CQE18851	52	R5CQE20125	50,53	R5CQE2034	49
R5CQE1848	48	R5CQE1885R	44,245,264	R5CQE20125R	45	R5CQE2034R	44
R5CQE1848R	43	R5CQE1885S	39	R5CQE20125S	40	R5CQE2034S	40
R5CQE1848S	39	R5CQE1885T	54	R5CQE20125T	55	R5CQE2035	49
R5CQE1848T	54	R5CQE1885V	60	R5CQE20125X	59	R5CQE2035R	44
R5CQE18610	48	R5CQE1885X	58,265	R5CQE20126	50,53	R5CQE2035S	40
R5CQE18610R	43	R5CQE1886	49	R5CQE20126R	45	R5CQE2036	49
R5CQE18610S	39	R5CQE18861	52	R5CQE20126S	40	R5CQE2036R	44

Indice Index

R5CQE2036S	40	R5CQE2068X	58,265	R5CQE221061	53	R5CQE2244R	45
R5CQE2038	49	R5CQE20810	49	R5CQE22106R	45	R5CQE2244S	41
R5CQE2038R	44	R5CQE208101	52	R5CQE22106S	41	R5CQE2245	50
R5CQE2038S	40	R5CQE20810R	44	R5CQE22106T	56	R5CQE2245R	45
R5CQE20410	49	R5CQE20810S	40	R5CQE22106X	59	R5CQE2245S	41
R5CQE20410R	44	R5CQE20810V	61	R5CQE22108	50	R5CQE2245T	56
R5CQE20410S	40	R5CQE20810X	59	R5CQE221081	53	R5CQE2246	50
R5CQE2043	49	R5CQE2083	49	R5CQE22108R	45	R5CQE2246R	45
R5CQE2043R	44	R5CQE20831	52	R5CQE22108S	41	R5CQE2246S	41
R5CQE2043S	40	R5CQE2083R	44	R5CQE22108T	56	R5CQE2246T	56
R5CQE2044	49	R5CQE2083S	40	R5CQE22108X	59	R5CQE2248	50
R5CQE2044R	44	R5CQE2083V	61	R5CQE221210	53	R5CQE2248R	45
R5CQE2044S	40	R5CQE2083X	58	R5CQE221210R	46	R5CQE2248S	41
R5CQE2044T	55	R5CQE2084	49	R5CQE221210S	41	R5CQE2248T	56
R5CQE2045	49	R5CQE20841	52	R5CQE221210X	59	R5CQE22610	50
R5CQE2045R	44	R5CQE2084R	44,245,264	R5CQE22124	53	R5CQE22610R	45
R5CQE2045S	40	R5CQE2084S	40	R5CQE22124R	45	R5CQE22610S	41
R5CQE2045T	55	R5CQE2084T	55	R5CQE22124S	41	R5CQE22610X	59
R5CQE2046	49	R5CQE2084V	61	R5CQE22124X	59	R5CQE2263	50
R5CQE2046R	44	R5CQE2084X	58,265	R5CQE22125	53	R5CQE2263R	45
R5CQE2046S	40	R5CQE2085	49	R5CQE22125R	46	R5CQE2263S	41
R5CQE2046T	55	R5CQE20851	52	R5CQE22125S	41	R5CQE2263X	59
R5CQE2048	49	R5CQE2085R	44,245,264	R5CQE22125T	56	R5CQE2264	50
R5CQE2048R	44	R5CQE2085S	40	R5CQE22125X	59	R5CQE2264R	45
R5CQE2048S	40	R5CQE2085T	55	R5CQE22126	53	R5CQE2264S	41
R5CQE2048T	55	R5CQE2085V	61	R5CQE22126R	46	R5CQE2264X	59
R5CQE20610	49	R5CQE2085X	58,265	R5CQE22126S	41	R5CQE2265	50
R5CQE20610R	44	R5CQE2086	49	R5CQE22126T	56	R5CQE2265R	45,246,265
R5CQE20610S	40	R5CQE20861	52	R5CQE22126X	59	R5CQE2265S	41
R5CQE20610V	61	R5CQE2086R	44,245,264	R5CQE22128	53	R5CQE2265T	56
R5CQE20610X	58	R5CQE2086S	40	R5CQE22128R	46	R5CQE2265X	59,267
R5CQE2063	49	R5CQE2086T	55	R5CQE22128S	41	R5CQE2266	50
R5CQE2063R	44	R5CQE2086V	61	R5CQE22128T	56	R5CQE2266R	45,246,265
R5CQE2063S	40	R5CQE2086X	58,265	R5CQE22128X	59	R5CQE2266S	41
R5CQE2063V	61	R5CQE2088	49	R5CQE22310	50	R5CQE2266T	56
R5CQE2063X	58	R5CQE20881	52	R5CQE22310R	45	R5CQE2266X	59,267
R5CQE2064	49	R5CQE2088R	44,245,264	R5CQE22310S	41	R5CQE2268	50
R5CQE2064R	44,245,264	R5CQE2088S	40	R5CQE2233	50	R5CQE2268R	45,246,265
R5CQE2064S	40	R5CQE2088T	55	R5CQE2233R	45	R5CQE2268S	41
R5CQE2064T	55	R5CQE2088V	61	R5CQE2233S	41	R5CQE2268T	56
R5CQE2064V	61	R5CQE2088X	59,265	R5CQE2234	50	R5CQE2268X	59,267
R5CQE2064X	58,265	R5CQE221010	50	R5CQE2234R	45	R5CQE22810	50
R5CQE2065	49	R5CQE2210101	53	R5CQE2234S	41	R5CQE228101	53
R5CQE2065R	44,245,264	R5CQE221010R	45	R5CQE2235	50	R5CQE22810R	45
R5CQE2065S	40	R5CQE221010S	41	R5CQE2235R	45	R5CQE22810S	41
R5CQE2065T	55	R5CQE221010X	59	R5CQE2235S	41	R5CQE22810X	59
R5CQE2065V	61	R5CQE22104	50	R5CQE2236	50	R5CQE2283	50
R5CQE2065X	58,265	R5CQE221041	53	R5CQE2236R	45	R5CQE22831	53
R5CQE2066	49	R5CQE22104R	45	R5CQE2236S	41	R5CQE2283R	45
R5CQE2066R	44,245,264	R5CQE22104S	41	R5CQE2238	50	R5CQE2283S	41
R5CQE2066S	40	R5CQE22104T	56	R5CQE2238R	45	R5CQE2283X	59
R5CQE2066T	55	R5CQE22104X	59	R5CQE2238S	41	R5CQE2284	50
R5CQE2066V	61	R5CQE22105	50	R5CQE22410	50	R5CQE22841	53
R5CQE2066X	58,265	R5CQE221051	53	R5CQE22410R	45	R5CQE2284R	45
R5CQE2068	49	R5CQE22105R	45	R5CQE22410S	41	R5CQE2284S	41
R5CQE2068R	44,245,264	R5CQE22105S	41	R5CQE2243	50	R5CQE2284T	56
R5CQE2068S	40	R5CQE22105T	56	R5CQE2243R	45	R5CQE2284X	59
R5CQE2068T	55	R5CQE22105X	59	R5CQE2243S	41	R5CQE2285	50
R5CQE2068V	61	R5CQE22106	50	R5CQE2244	50	R5CQE22851	53

Indice Index

R5CQE2285R	45,246,265	R5CRE1460	189	R5IE54	308	R5LE600	204
R5CQE2285S	41	R5CRE1480	189	R5IE55	308	R5LE800	204
R5CQE2285T	56	R5CRE16100	189	R5IE64	308	R5LEMC2062	78
R5CQE2285X	59,267	R5CRE16120	189	R5IE66	308	R5LEMC2082	78
R5CQE2286	50	R5CRE1640	189	R5IE75	308	R5LSC50	199
R5CQE22861	53	R5CRE1660	189	R5IE86	308	R5LSC60	199
R5CQE2286R	45,246,265	R5CRE1680	189	R5KFRE18100	166	R5LSC80	199
R5CQE2286S	41	R5CRE18100	191	R5KFRE18120	166	R5LSE50	197
R5CQE2286T	56	R5CRE18120	191	R5KFRE1860	166	R5LSE60	197
R5CQE2286X	59,267	R5CRE1830	191	R5KFRE1880	166	R5LSE80	197
R5CQE2288	50	R5CRE1840	191	R5KFRE20100	166	R5MPC1000	359
R5CQE22881	53	R5CRE1860	191	R5KFRE20120	166	R5MPC1200	359
R5CQE2288R	45,246,265	R5CRE1880	191	R5KFRE2040	166	R5MPC1600	359
R5CQE2288S	41	R5CRE20100	191	R5KFRE2060	166	R5MPC600	359
R5CQE2288T	56	R5CRE20120	191	R5KFRE2080	166	R5MPC800	359
R5CQE2288X	59,267	R5CRE20140	191	R5KFRE22100	166	R5MPV1000	363
R5CQEA1855	61	R5CRE20160	191	R5KFRE22120	166	R5MPV1200	363
R5CQEA1866	61	R5CRE2030	191	R5KFRE2240	166	R5MPV1600	363
R5CQEA1888	61	R5CRE2040	191	R5KFRE2260	166	R5MPV600	363
R5CQEA2055	61	R5CRE2060	191	R5KFRE2280	166	R5MPV800	363
R5CQEA2066	61	R5CRE2080	191	R5KMN12	37	R5MRCE10	224
R5CQEA2088	61	R5CRE22100	191	R5KMN14	37	R5MRCE12	224
R5CQEC1666	68,70	R5CRE22120	191	R5KMN16	37	R5MRCE14	224
R5CQEC1666	70	R5CRE2230	191	R5KMN18	37	R5MRCE16	224
R5CQEC1666P	69,70	R5CRE2240	191	R5KMN20	37	R5MRCE18	224
R5CQEC1666P	70	R5CRE2260	191	R5KMN22	37	R5MRCE20	224
R5CQEC1668	68,70	R5CRE2280	191	R5LE1000	204	R5MRCE22	224
R5CQEC1668	70	R5CRE8121	122	R5LE1200	204	R5MRE10	223
R5CQEC1668P	69,70	R5CRE8141	122	R5LE12102	191	R5MRE12	223
R5CQEC1668P	70	R5CRE8161	122	R5LE1242	191	R5MRE14	223
R5CQEC1866	68,70	R5CRE8181	122	R5LE1252	191	R5MRE16	223
R5CQEC1866	70	R5CRE8201	122	R5LE1262	191	R5MRE18	223
R5CQEC1866P	69,70	R5CRK1460	222	R5LE1442	191	R5MRE20	223
R5CQEC1866P	70	R5CRK1660	222	R5LE1452	191	R5MRE22	223
R5CQEC1868	68,70,72	R5CRK1860	222	R5LE1642	191	R5MRE8	70
R5CQEC1868P	69,70,72	R5CRK2060	222	R5LE1652	191	R5MRE9	70
R5CQEC2066	68,70,72	R5CRK2260	222	R5LE1662	191	R5PA6040	278
R5CQEC2066P	69,70,72	R5CV1000	364	R5LE1682	191	R5PA6060	278
R5CQEC2068	68,70,72	R5CV1200	364	R5LE18102	191	R5PA8040	278
R5CQEC2068P	69,70,72	R5CV1600	364	R5LE18122	191	R5PA8060	278
R5CQEMC2066	77	R5CV600	364	R5LE1832	191	R5PCD60	273
R5CQEMC2068	77	R5CV800	364	R5LE1842	191	R5PCD80	273
R5CQEMC2086	77	R5CVCE18250	200	R5LE1852	191	R5PCDF01	228
R5CQEMC2088	77	R5CVCE18260	200	R5LE1862	191	R5PDS105	197
R5CRE10100	189	R5CVCE18280	200	R5LE1882	191	R5PDS106	197
R5CRE10121	122	R5CVCE20250	200	R5LE20102	193	R5PDS108	197
R5CRE10141	122	R5CVCE20260	200	R5LE20122	193	R5PDS125	197
R5CRE10161	122	R5CVCE20280	200	R5LE2032	193	R5PDS126	197
R5CRE10181	122	R5FRV18	225	R5LE2042	193	R5PDS128	197
R5CRE10201	122	R5FRV20	225	R5LE2052	193	R5PDS45	197
R5CRE1060	189	R5FRV22	225	R5LE2062	193	R5PDS46	197
R5CRE1080	189	R5IE16	309	R5LE2082	193	R5PDS48	197
R5CRE12100	189	R5IE18	309	R5LE22102	193	R5PDS65	197
R5CRE1240	189	R5IE26	309	R5LE22122	193	R5PDS66	197
R5CRE1260	189	R5IE28	309	R5LE2232	193	R5PDS68	197
R5CRE1280	189	R5IE43	308	R5LE2242	193	R5PDS85	197
R5CRE14100	189	R5IE44	308	R5LE2252	193	R5PDS86	197
R5CRE14120	189	R5IE46	308	R5LE2262	193	R5PDS88	197
R5CRE14160	189	R5IE53	308	R5LE2282	193	R5PFC5150	307

■ Indice Index

R5PFC5151	306	R5PIE1480	179	R5RL1000	202	R5SMSRF	413
R5PFC5300	307	R5PIE16100	179	R5RL600	202	R5SMSTR	409
R5PFC5301	306	R5PIE1660	179	R5RL800	202	R5TE100	206
R5PFC6180	307	R5PIE1680	179	R5SCC50	198	R5TE14	272
R5PFC6181	306	R5PIE18100	180	R5SCC60	198	R5TE16	272
R5PFC6360	307	R5PIE18120	180	R5SCC80	198	R5TE18	272
R5PFC6361	306	R5PIE1860	180	R5SCE105	195	R5TE20	272
R5PFC8180	307	R5PIE1880	180	R5SCE106	195	R5TE22	272
R5PFC8181	306	R5PIE20100	180	R5SCE108	195	R5TE50	206
R5PFC8360	307	R5PIE20120	180	R5SCE125	195	R5TE60	206
R5PFC8361	306	R5PIE2060	180	R5SCE126	195	R5TE70	206
R5PFI1840	281	R5PIE2080	180	R5SCE128	195	R5TE80	206
R5PFI1850	281	R5PIE22100	180	R5SCE45	195	R5TIE16100	219
R5PFI1860	281	R5PIE22120	180	R5SCE46	195	R5TIE1660	217
R5PFI1880	281	R5PIE2260	180	R5SCE48	195	R5TIE1680	216
R5PFI2040	281	R5PIE2280	180	R5SCE65	195	R5TIE18100	219
R5PFI2050	281	R5PN1000	356,368	R5SCE66	195	R5TIE1860	217
R5PFI2060	281	R5PN1200	356,368	R5SCE68	195	R5TIE1880	216
R5PFI2080	281	R5PN1600	356,368	R5SCE85	195	R5TIE20100	219
R5PI5100	277	R5PN2000	356,368	R5SCE86	195	R5TIE2060	217
R5PI5150	276	R5PN600	356,368	R5SCE88	195	R5TIE2080	216
R5PI5151	273	R5PN800	356,368	R5SCRK01	228	R5TIE22100	219
R5PI520	276	R5PRK1	226	R5SFMR01	225	R5TIE2260	217
R5PI520A	277	R5PRK10	226	R5SHGPT80	420	R5TIE2280	216
R5PI521	273	R5PRK11	226	R5SHSAF	423	R5TIE460	311
R5PI522	275	R5PRK12	226	R5SHSAP	420	R5TIE461	311
R5PI524	275	R5PRK2	226	R5SHSDF	424	R5TIE660	311
R5PI530	276	R5PRK3	226	R5SHSIN	421	R5TIE860	311
R5PI531	273	R5PRK4	226	R5SHSRF	425	R5TIE861	311
R5PI540	276	R5PRK5	226	R5SHSTR	422	R5TIEC1680	218
R5PI541	273	R5PRK6	226	R5SLGPT48	387	R5TIEC1880	218
R5PI550	276	R5PRK7	226	R5SLGPT70	388	R5TIEC2080	218
R5PI560	276	R5PRK8	226	R5SLSAF	390	R5TIEC2280	218
R5PI561	273	R5PRK9	226	R5SLSAP	389	R5TIEP12	220
R5PI580	277	R5PT600	206	R5SLSAV	391	R5TIEP16	220
R5PI7100	277	R5PT800	206	R5SLSAVR	392	R5TIEP18	220
R5PI7150	276	R5RE640	203	R5SLSDF	393	R5TIEP6	220
R5PI7151	273	R5RE650	203	R5SLSDI	394	R5TIEP9	220
R5PI720	276	R5RE660	203	R5SLSIN	395	R5TMC43	304
R5PI720A	277	R5RE680	203	R5SLSRF	396	R5TMC44	304
R5PI721	273	R5RE840	203	R5SLSRI	397	R5TMC53	304
R5PI722	275	R5RE850	203	R5SLSTR	388	R5TMC54	304
R5PI724	275	R5RE860	203	R5SLT51	411	R5TMC55	304
R5PI730	276	R5RE880	203	R5SLT52	411	R5TMC64	304
R5PI731	273	R5REIT30	230	R5SLT55	411	R5TMN106	305
R5PI740	276	R5RF1040	203	R5SLT61	398	R5TMN108	305
R5PI741	273	R5RF1050	203	R5SLT65	398	R5TMN126	305
R5PI750	276	R5RF1060	203	R5SLT81	426	R5TMN128	305
R5PI760	276	R5RF1080	203	R5SLT82	426	R5TMN66	305
R5PI761	273	R5RF640	203	R5SLT85	426	R5TMN75	305
R5PI780	277	R5RF650	203	R5SLTC1	399	R5TMN86	305
R5PIE10100	179	R5RF660	203	R5SLTC5	399	R5TOE60	247
R5PIE1060	179	R5RF680	203	R5SLTC71	400	R5TOE80	247
R5PIE1080	179	R5RF840	203	R5SLTC75	400	R5TT042	309
R5PIE12100	179	R5RF850	203	R5SMGPT50	407	R5TT049	309
R5PIE1260	179	R5RF860	203	R5SMSAF	410	R5TT052	309
R5PIE1280	179	R5RF880	203	R5SMSAP	407	R5TT059	309
R5PIE14100	179	R5RFIT250	229	R5SMSDF	412	R5TT063	309
R5PIE1460	179	R5RFIT400	229	R5SMSIN	408	R5TT069	309

Indice Index

R5TT083	309	RICE313	346	RIPFC61801	342	RZAE02	181
R5TT084	309	RICEB03311	334	RIPFC61811	342	RZAE03	220
RAA07	239	RICEB03411	334	RIPFC81801	342	RZAE04	233
RAA21	240	RICEB03911	334	RIPFC81811	342	RZAE05	129
RAA24	240	RICEB04311	334	RIPN10001	375	RZAE06	134
RAA45	156	RICEB04321	334	RIPN12001	375	RZAE09	181
RAA51	239	RICEB04421	334	RIPN6001	375	RZAEL01	180
RAA52	239	RICEB04621	334	RIPN8001	375	RZBPE60	279
RAA53	157	RICEB05311	334	RITMC431	340	RZBPE80	279
RAA54	240	RICEB05321	334	RITMC541	340	RZBS01	184
RAA56	241	RICEB05421	334	RITMC641	340	RZBS02	184
RAAE07	135	RICEB05491	334	RITMN1061	341	RZBS03	184
RAKASCE600	315	RICEB05521	334	RITMN1081	341	RZBS04	185
RAKASCE800	315	RICEB06421	335	RITMN661	341	RZBS05	185
RAKASL0086	241	RICEB06441	335	RITMN751	341	RZBS1000	185
RAKASL0088	241	RICEB06491	335	RITMN861	341	RZBS1200	185
RAKASM0086	242	RICEB06641	335	RITTO321	343	RZBS1400	185
RAKASM0088	242	RICEB06691	335	RITTO491	343	RZBS1600	185
RAKASS2086	242	RICEB06831	336	RITTO591	343	RZBS400	185
RAKASS2088	242	RICEB07521	335	RITTO631	343	RZBS600	185
RAKL10W	236	RICEB07591	335	RITTO691	343	RZBS800	185
RAKSU	164	RICEB08121	336	RITTO831	343	RZCDA02	325
RALA013	234	RICEB08131	336	RITTO831	343	RZCDO15	324,349
RALA08	234	RICEB08631	335	RIZCOR11	376	RZCDO18	324,349
RALL04WMS	237	RICEB08641	335	RIZPRO10011	376	RZCDO20	324,349
RALL05WNM	236	RICEB08691	335	RIZPRO12011	376	RZCDO30	324,349
RALL06W240	235	RICEB08831	335	RIZPRO3811	376	RZCDO40	324,349
RAMC01	238	RICEB08841	335	RIZPRO6011	376	RZCDO50	324,349
RAMC02	238	RICEB10131	336	RIZPRO8011	376	RZCDO60	324,349
RAMC05	238	RICEB10631	335	RPA25	429	RZCDO80	324,349
RAMP01	162	RICEB10641	335	RPA32	205,367	RZCDP11	325,350
RAMP04	162	RICEB10691	335	RPCE205	312,346	RZCDP22	325,350
RAMP09	162	RICEB10831	335	RPCE209	371	RZCDP29	325,350
RATS1000	176	RICEB10841	335	RPCE240	312,346	RZCDP31	325,350
RATS1200	176	RICEB121231	336	RPCE243	312,346	RZCDP32	325,350
RATS600	176	RICEB12131	336	RPCE245	312,346	RZCDP33	325,350
RATS800	176	RICEB12631	335	RPCE246	312,346	RZCDP42	325,350
RIA502	344	RICEB12831	335	RPCE500	186	RZCDP43	325,350
RICDE111201	347	RICEB14131	336	RPCE501	186	RZCDP44	325,350
RICDE11801	347	RICEB14631	335	RPCE502	186	RZCDP52	325,350
RICDE221201	347	RICEB14831	335	RPCE503	186	RZCDP53	325,350
RICDE22801	347	RICEXB04321	337	RPCE504	186	RZCDP62	325,350
RICDE311201	347	RICEXB05491	337	RPCE505	186	RZCDP63	325,350
RICDE321201	347	RICEXB06491	337	RPCE510	187	RZCDP64	325,350
RICDE32801	347	RICEXB06691	337	RPCE512	187	RZCDP82	327,351
RICDE331201	347	RICEXB07591	337	RPCE513	187	RZCDP84	327,351
RICDE421201	347	RICEXB08631	337	RZA05	233	RZCDP91	325,350
RICDE42801	347	RICEXB10631	338	RZA06	233	RZCE200	313,347
RICDE431201	347	RICEXB10831	338	RZA31	312	RZCE206	346
RICDE441201	347	RIIE161	338	RZA33	232	RZCE211	313,347
RICDE521201	347	RIIE181	338	RZA34	367	RZCE212	313,347
RICDE531201	347	RIIE431	338	RZA36	232	RZCE213	313,347
RICDE621201	349	RIIE541	338	RZA41	158	RZCE214	313,347
RICDE62801	349	RIIE641	338	RZA62	314,324	RZCE219	313,347
RICDE631201	349	RIIE661	338	RZAD2400	202	RZCE221	312,346
RICDE641201	349	RIIE751	338	RZAD2406	202	RZCE223	312,346
RICDE821201	349	RIIE861	338	RZAD2410	202	RZCE224	312,346
RICDE82801	349	RIPFC51501	342	RZAD2416	202	RZCE226	312,346
RICDE841201	349	RIPFC51511	342	RZAE01	180	RZCE227	312,346

Indice Index

RZCE228	312,346	RZDPC96	290	RZFMP600	161	RZPC600	365
RZCE230	189,313,347	RZDSF01	288	RZFMP800	161	RZPC800	365
RZCE233	189,313,347	RZDSF02	289	RZFFPC1000	161	RZPCDE1840	201
RZCE234	189,313,347	RZDSL20	283	RZFFPC1200	161	RZPCDE1850	201
RZCE235	189,313,347	RZDSL30	283	RZFFPC1400	161	RZPCDE1860	201
RZCE236	189,313,347	RZDSL40	283	RZFFPC1600	161	RZPCDE1880	201
RZCE237	312,346	RZDTF100	287	RZFFPC400	161	RZPCDE2040	201
RZCE261	312,346	RZDTF120	287	RZFFPC600	161	RZPCDE2050	201
RZCE510	189	RZDTF30	287	RZFFPC800	161	RZPCDE2060	201
RZCE511	189	RZDTF40	287	RZFUC103	159	RZPCDE2080	201
RZCE512	189	RZDTF60	287	RZFUC104	159	RZPCE10100	126
RZCE513	189	RZDTF80	287	RZFUC105	159	RZPCE1060	126
RZCE514	189	RZDVE1440	193	RZFUC106	159	RZPCE1080	126
RZCE515	189	RZDVE1450	193	RZFUC108	159	RZPCE12100	126
RZCE516	189	RZDVE1640	193	RZFUC124	159	RZPCE12120	126
RZCE517	189	RZDVE1650	193	RZFUC125	159	RZPCE1240	126
RZCE518	189	RZDVE1660	193	RZFUC126	159	RZPCE1260	126
RZCE519	189	RZDVE1830	193	RZFUC44	159	RZPCE1280	126
RZCPCE10120	120	RZDVE1840	193,257,279	RZFUC45	159	RZPCE14100	126
RZCPCE10140	120	RZDVE1850	193,257,279	RZFUC46	159	RZPCE14120	126
RZCPCE10160	120	RZDVE1860	193,257,279	RZFUC48	159	RZPCE14160	126
RZCPCE10180	120	RZDVE1880	193,257,279	RZFUC63	159	RZPCE1460	126
RZCPCE10200	120	RZDVE2030	193	RZFUC64	159	RZPCE1480	126
RZCPCE8120	120	RZDVE2040	193,257,279	RZFUC65	159	RZPCE16100	127
RZCPCE8140	120	RZDVE2050	193,257,279	RZFUC66	159	RZPCE16120	127
RZCPCE8160	120	RZDVE2060	193,257,279	RZFUC68	159	RZPCE1640	127
RZCPCE8180	120	RZDVE2080	193,257,279	RZFUC83	159	RZPCE1660	127
RZCPCE8200	120	RZDVE2240	195	RZFUC84	159	RZPCE1680	127
RZDGD60	286	RZDVE2250	195,257,279	RZFUC85	159	RZPCE18100	127
RZDGD80	286	RZDVE2260	195,257,279	RZFUC86	159	RZPCE18120	127
RZDGR60	288	RZDVE2280	195,257,279	RZFUC88	159	RZPCE1830	127
RZDGR80	288	RZDVP18100	279	RZG01	240	RZPCE1840	127
RZDL40	286	RZDVP18125	257	RZG02	240	RZPCE1860	127
RZDL50	286	RZDVP18150	279	RZG03	240	RZPCE1880	127
RZDL60	286	RZDVP18175	257	RZKE65	163	RZPCE20100	127
RZDL80	286	RZDVP18250	279	RZKEMC65	77	RZPCE20120	127
RZDOE6095	284	RZDVP18275	257	RZKFSCOR01	155	RZPCE20140	127
RZDOE6145	255,284	RZDVP18325	257	RZKFSCOR02	154	RZPCE20160	127
RZDOE6195	255	RZDVP18350	279	RZKRE65	165	RZPCE2030	127
RZDOE6245	255,284	RZDVP20100	279	RZKSRE65	165	RZPCE2040	127
RZDOE6295	255	RZDVP20125	257	RZKUPCSE	134	RZPCE2060	127
RZDOE6345	255,284	RZDVP20150	279	RZMPG20	371	RZPCE2080	127
RZDOE6445	255,284	RZDVP20175	257	RZMPG25	371	RZPCE22100	127
RZDOE6545	255	RZDVP20250	279	RZMPG30	371	RZPCE22120	127
RZDOE6645	284	RZDVP20275	257	RZMPG35	371	RZPCE2230	127
RZDOE6745	255	RZDVP20325	257	RZMPG40	371	RZPCE2240	127
RZDOE8095	284	RZDVP20350	279	RZMVE18	258,270	RZPCE2260	127
RZDOE8145	255,284	RZDVP22100	279	RZMVE20	258,270	RZPCE2280	127
RZDOE8195	255	RZDVP22125	257	RZMVE22	258,270	RZPCE61000	250,269
RZDOE8245	255,284	RZDVP22150	279	RZPAC100	214	RZPCE6200	248,267
RZDOE8295	255	RZDVP22175	257	RZPAC120	214	RZPCE6300	248,267
RZDOE8345	255,284	RZDVP22250	279	RZPAC140	214	RZPCE6400	248,267
RZDOE8445	255,284	RZDVP22275	257	RZPAC160	214	RZPCE6500	248,267
RZDOE8545	255	RZDVP22325	257	RZPAC40	214	RZPCE6600	72,248,267
RZDOE8645	284	RZDVP22350	279	RZPAC60	214	RZPCE6800	72,248,267
RZDOE8745	255	RZFCP60	281	RZPAC80	214	RZPCE6900	248,267
RZDPC22	291	RZFCP80	281	RZPC1000	365	RZPCE81000	250,269
RZDPC30	291	RZFMP1000	161	RZPC1200	365	RZPCE8200	248,267
RZDPC72	290	RZFMP1200	161	RZPC1600	365	RZPCE8300	248,267

Indice Index

RZPCE8400	248,267	RZPCSE22120	129	RZPM44	429	RZSMRSTR	415
RZPCE8500	248,267	RZPCSE2260	129	RZPM45	429	RZSOE095	284
RZPCE8600	248,267	RZPCSE2280	129	RZPM54	429	RZSOE145	255,269,284
RZPCE8800	248,267	RZPDF1000	210	RZPM55	429	RZSOE195	255,269
RZPCE8900	248,267	RZPDF1200	210	RZPPM1000	365	RZSOE245	255,269,284
RZPCES1080	85	RZPDF1400	210	RZPPM1200	365	RZSOE295	255,269
RZPCES12100	85	RZPDF1600	210	RZPPM1600	365	RZSOE345	255,269,284
RZPCES1480	85	RZPDF400	210	RZPPM600	365	RZSOE445	255,269,284
RZPCES16100	85	RZPDF600	210	RZPPM800	365	RZSOE545	255,269
RZPCES1660	85	RZPDF800	210	RZPSP18100	132	RZSOE645	284
RZPCES1680	85	RZPDL1000	207	RZPSP18120	132	RZSOE745	255,269
RZPCES18100	85	RZPDL1200	207	RZPSP1860	132	RZSRP01	233
RZPCES1880	85	RZPDL400	207	RZPSP1880	132	RZSRP02	233
RZPCES2080	85	RZPDL500	207	RZPSP20100	132	RZSTS	177
RZPCPE1010	128	RZPDL600	207	RZPSP20120	132	RZTFE1000	213
RZPCPE106	128	RZPDL800	207	RZPSP2060	132	RZTFE1200	213
RZPCPE108	128	RZPDV14	209	RZPSP2080	132	RZTFE1400	213
RZPCPE1210	128	RZPDV16	209	RZRPC100	131	RZTFE1600	213
RZPCPE126	128	RZPDV18	209	RZRPC120	131	RZTFE400	213
RZPCPE128	128	RZPDV20	209	RZRPC140	131	RZTFE600	213
RZPCPE610	128	RZPDV22	209	RZRPC160	131	RZTFE800	213
RZPCPE66	128	RZPF33	430	RZRPC60	131	RZTLE1000	211
RZPCPE68	128	RZPF34	430	RZRPC80	131	RZTLE1200	211
RZPCPE810	128	RZPF43	430	RZRPCSE30	132	RZTLE400	211
RZPCPE86	128	RZPF44	430	RZS01	367,376	RZTLE500	211
RZPCPE88	128	RZPF45	430	RZS02	368	RZTLE600	211
RZPCSE16100	129	RZPF54	430	RZS100	310,345	RZTLE800	211
RZPCSE16120	129	RZPF55	430	RZS120	310,345	RZTPE100	177
RZPCSE1660	129	RZPIE14	163	RZS140	310,345	RZTPE50	177
RZPCSE1680	129	RZPIE16	163	RZS50	310,345	RZTPE60	177
RZPCSE18100	129	RZPIE18	163	RZS60	310,345	RZTPE70	177
RZPCSE18120	129	RZPIE20	163	RZS70	310,345	RZTPE80	177
RZPCSE1860	129	RZPIE22	163	RZS80	310,345	RZTSE02	232
RZPCSE1880	129	RZPLE1000	212	RZSHPR	427	RZTTE1000	215
RZPCSE20100	129	RZPLE400	212	RZSHRSAP	427	RZTTE1200	215
RZPCSE20120	129	RZPLE500	212	RZSHRSTR	427	RZTTE1400	215
RZPCSE20140	129	RZPLE600	212	RZSLPR	402	RZTTE1600	215
RZPCSE20160	129	RZPLE800	212	RZSLRSAP	401	RZTTE600	215
RZPCSE2060	129	RZPM33	429	RZSLRSTR	402	RZTTE800	215
RZPCSE2080	129	RZPM34	429	RZSMPR	415		
RZPCSE22100	129	RZPM43	429	RZSMRSAP	415		



DKC Europe Srl - RamBlock Division

via Libertà, 207 · 28043 Bellinzago Novarese (NO) Italy

tel. +39 0321 989898

info@dkceurope.eu

www.dkceurope.com